



User manual  
netTAP NT 100  
Gateway Devices



Hilscher Gesellschaft für Systemautomation mbH  
[www.hilscher.com](http://www.hilscher.com)

DOC081001UM20EN | Revision 20 | English | 2021-03 | Released | Public

# Table of contents

<b>1</b>	<b>Introduction .....</b>	<b>5</b>
1.1	About the user manual .....	5
1.1.1	List of revisions .....	5
1.1.2	Conventions in this manual .....	5
1.2	Reference to device, software, driver and firmware .....	6
1.3	Contents of the product DVD .....	7
1.3.1	Directory structure of the DVD .....	7
1.3.2	Device description files .....	8
1.3.3	Documentation for netTAP .....	9
<b>2</b>	<b>Safety .....</b>	<b>13</b>
2.1	General note about safety .....	13
2.2	Intended use .....	13
2.3	Personnel qualification .....	13
2.4	References safety .....	14
2.5	Safety instructions to avoid personal injury .....	14
2.6	Safety instructions to avoid property damage .....	15
2.6.1	Power disconnect during firmware or configuration download .....	15
2.6.2	Device destruction by exceeding allowed supply voltage .....	16
2.6.3	Exceeding the maximum number of allowed write/delete accesses .....	16
2.6.4	Danger of unsafe system operation .....	16
2.7	Labeling of safety messages .....	17
<b>3</b>	<b>Description and requirements .....</b>	<b>18</b>
3.1	Brief description .....	18
3.2	Device type name .....	19
3.3	Protocol conversions .....	21
3.3.1	Protocol conversion 1: Ethernet to Fieldbus .....	21
3.3.2	Protocol conversion 2: Ethernet to Serial .....	23
3.3.3	Protocol conversion 3: Fieldbus to Fieldbus .....	24
3.3.4	Protocol conversion 4: Fieldbus to Serial .....	25
3.4	Requirements .....	26
3.4.1	Requirements for operation .....	26
3.4.2	Configuration software requirements .....	27
3.5	Licenses .....	28
<b>4</b>	<b>Device drawings and connectors .....</b>	<b>29</b>
4.1	Dimensional drawings .....	29
4.2	Device label .....	29
4.3	LEDs and control elements .....	30
4.3.1	LEDs and control elements of the upper half of the device .....	30
4.3.2	LEDs of the lower half of the device .....	31
4.4	Device drawings: Left side (connector X2) .....	32
4.5	Device drawings: Right side (connector X3) .....	33
4.6	Connectors and interfaces .....	34
4.6.1	X1 power supply .....	34
4.6.2	X2/X3 Front connectors .....	34

4.6.3	Diagnostic interface (Mini-B USB) .....	38
4.7	Schematic diagrams - Galvanic Isolation .....	39
4.7.1	Galvanic isolation in case of NT 100-RE-XX devices .....	39
4.7.2	Galvanic isolation in case of NT 100-DP-XX, NT 100-CO-XX, and NT 100-DN-XX devices .....	41
<b>5</b>	<b>NT 100 mounting and dismounting.....</b>	<b>43</b>
5.1	Mounting instructions .....	43
5.2	DIN top hat rail mounting of the NT 100.....	43
5.3	Dismounting the NT 100 from the DIN top hat rail .....	44
<b>6</b>	<b>Installing the driver.....</b>	<b>45</b>
<b>7</b>	<b>Commissioning.....</b>	<b>46</b>
7.1	Load firmware and configuration.....	46
7.1.1	Download configuration files with the PC.....	46
7.1.2	Transfer configuration using a memory card .....	46
7.2	Start-up behavior.....	48
7.2.1	Start-up without memory card.....	48
7.2.2	Start-up with memory card.....	48
7.2.3	Reset device to factory settings with memory card.....	49
7.2.4	Boot-up behaviour on invalid firmware.....	49
<b>8</b>	<b>Troubleshooting.....</b>	<b>57</b>
8.1	Troubleshooting tips.....	57
8.2	Failure in 10 MBit/s half-duplex mode and workaround .....	58
<b>9</b>	<b>LEDs.....</b>	<b>59</b>
9.1	SYS.....	59
9.2	APL .....	60
9.3	LEDs Real-Time Ethernet systems .....	61
9.3.1	LEDs EtherCAT Master .....	61
9.3.2	LEDs EtherCAT Slave .....	63
9.3.3	LEDs EtherNet/IP Scanner .....	64
9.3.4	LEDs EtherNet/IP Adapter .....	66
9.3.5	LEDs Open Modbus/TCP .....	68
9.3.6	LEDs POWERLINK Controlled Node.....	69
9.3.7	LEDs PROFINET IO-Controller .....	70
9.3.8	LEDs PROFINET IO-Device .....	72
9.3.9	LEDs Sercos Master .....	73
9.3.10	LEDs Sercos Slave .....	75
9.4	LEDs Fieldbus systems.....	77
9.4.1	LED CANopen Master .....	77
9.4.2	LED CANopen Slave .....	78
9.4.3	LED CC-Link Slave .....	79
9.4.4	LED DeviceNet Master .....	80
9.4.5	LED DeviceNet Slave .....	81
9.4.6	LED PROFIBUS DP Master.....	82
9.4.7	LED PROFIBUS DP Slave.....	83
9.5	LEDs Serial .....	84
9.5.1	LED Modbus RTU.....	84
9.5.2	LED ASCII.....	85
9.5.3	LED Serial with netSCRIPT .....	86

9.5.4	LED 3964R .....	87
<b>10</b>	<b>Technical data .....</b>	<b>88</b>
10.1	Technical data netTAP NT 100 Gateway .....	88
10.2	Technical data of Real-Time Ethernet protocols .....	91
10.2.1	EtherCAT Master .....	91
10.2.2	EtherCAT Slave .....	92
10.2.3	EtherNet/IP Scanner .....	93
10.2.4	EtherNet/IP Adapter .....	94
10.2.5	Open Modbus/TCP .....	95
10.2.6	POWERLINK Controlled Node .....	95
10.2.7	PROFINET IO-Controller .....	96
10.2.8	PROFINET IO-Device .....	98
10.2.9	Sercos Master .....	99
10.2.10	Sercos Slave .....	100
10.3	Technical data of field bus protocols .....	101
10.3.1	CANopen Master .....	101
10.3.2	CANopen Slave .....	102
10.3.3	CC-Link Slave .....	103
10.3.4	DeviceNet Master .....	104
10.3.5	DeviceNet Slave .....	105
10.3.6	PROFIBUS DP Master .....	106
10.3.7	PROFIBUS DP Slave .....	107
10.4	Technical data of serial protocols .....	108
10.4.1	ASCII .....	108
10.4.2	Modbus RTU Master/Slave .....	109
10.4.3	netSCRIPT (Serial) .....	110
10.4.4	3964R .....	111
<b>11</b>	<b>Wiring instructions .....</b>	<b>112</b>
11.1	Assembly of D-Sub connectors .....	112
11.2	Ethernet .....	113
11.3	PROFIBUS .....	114
11.4	CANopen .....	115
11.5	DeviceNet .....	116
11.6	CC-Link .....	117
11.7	RS-232 .....	120
11.8	RS-422 .....	121
11.9	RS-485 .....	122
<b>12</b>	<b>Appendix .....</b>	<b>124</b>
12.1	Legal notes .....	124
12.2	Trademarks .....	128
	<b>Contacts .....</b>	<b>134</b>

# 1 Introduction

## 1.1 About the user manual

This user manual describes the hardware, installation, commissioning, and operation of the netTAP NT 100 device family.

### 1.1.1 List of revisions

Revision	Date	Change
19	2021-03-01	Firmware version 2.0
		Device NT 100-RE-EN removed.
		Section <i>LEDs</i> [▶ page 59] updated.
		Section <i>Technical data</i> [▶ page 88] updated.
20	2021-03-30	Section Technical Data <i>PROFINET IO-Device</i> [▶ page 98]: MRP Client added.

Table 1: List of revisions

### 1.1.2 Conventions in this manual

Notes, instructions, results of operating steps and positions in figures are marked as follows:

#### Notes



#### Important:

<important note you must follow to avoid malfunction>



#### Note:

<general note>



<note where to find further information>

#### Instructions

1. Operation purpose
2. Operation purpose
  - Instruction

#### Results

- ↻ Intermediate result
- ⇒ Final result

## Safety messages

The labeling of safety messages is explained in the chapter Safety.

The *positions* ①, ②, ③... or a, b, c... or A, B, C... refer to the figure used in that section. If the numbers reference to a section outside the current section then a cross reference to that section and figure is indicated.

## 1.2 Reference to device, software, driver and firmware

Device type	Part number	from revision	Port X2	Port X3
NT 100-RE-CC	1712.140	Revision 2	Ethernet	CC-Link
NT 100-RE-CO	1712.160	Revision 4	Ethernet	CANopen
NT 100-RE-DP	1712.180	Revision 4	Ethernet	PROFIBUS DP
NT 100-RE-DN	1712.170	Revision 4	Ethernet	DeviceNet
NT 100-RE-RS	1712.100	Revision 4	Ethernet	Serial
NT 100-DP-CC	1718.140	Revision 4	PROFIBUS DP	CC-Link
NT 100-DP-CO	1718.160	Revision 4	PROFIBUS DP	CANopen
NT 100-DP-DN	1718.170	Revision 4	PROFIBUS DP	DeviceNet
NT 100-DP-DP	1718.180	Revision 4	PROFIBUS DP	PROFIBUS DP
NT 100-DP-RS	1718.100	Revision 4	PROFIBUS DP	Serial
NT 100-CO-CC	1716.140	Revision 4	CANopen	CC-Link
NT 100-CO-CO	1716.160	Revision 3	CANopen	CANopen
NT 100-CO-DP	1716.180	Revision 1	CANopen	PROFIBUS DP
NT 100-CO-DN	1716.170	Revision 3	CANopen	DeviceNet
NT 100-CO-RS	1716.100	Revision 3	CANopen	Serial
NT 100-DN-CC	1717.140	Revision 4	DeviceNet	CC-Link
NT 100-DN-CO	1717.160	Revision 3	DeviceNet	CANopen
NT 100-DN-DP	1717.180	Revision 4	DeviceNet	PROFIBUS DP
NT 100-DN-DN	1717.170	Revision 3	DeviceNet	DeviceNet
NT 100-DN-RS	1717.100	Revision 4	DeviceNet	Serial

Table 2: Reference to device

Software	Software version
SYCON.net setup.exe	1.0500.201127.35275 and later

Table 3: Reference to software

Driver	Driver version
USB driver	USB driver of Windows®

Table 4: Reference to driver

Firmware for the protocol conversions, see section *Protocol conversions* [▶ page 21].

## 1.3 Contents of the product DVD

The product DVD for the netTAP NT 100 contains:

- Setup program for the configuration and diagnosis program SYCON.net
- USB driver
- Documentation
- Firmware
- Device description files (EDS, GSD, GSDML, ...)
- Tools

### 1.3.1 Directory structure of the DVD

All manuals on this DVD are delivered in the Adobe Acrobat® Reader format (PDF).

Directory	Description
Documentation	Documentation in the Acrobat® Reader Format (PDF)
Driver_&_Toolkit	Device driver Driver toolkit
Firmware_EDS_Examples_Webpages	Loadable firmware for netTAP NT 100 Device description files (EDS)
Software_&_Tools	SYCON.net

Table 5: Directory structure of the Gateway Solutions DVD

### 1.3.2 Device description files

The directory `Firmware,_EDS,_Examples,_Webpages`  
`\Firmware_&_EDS\netTAP 100\DeviceDescription` contains  
 device description files for netTAP NT 100.

NT 100	File name
CANopen Slave	NT100_CO_COS.eds
CC-Link Slave	0x0352_NT100-CC_2.11_en.csproj 0x0352_NT100-CCS_2.11_en.cspp nt100-cc-ccs_1.csp (for one Remote Device Station), nt100-cc-ccs_2.csp (for two Remote Device Stations), nt100-cc-ccs_3.csp (for three Remote Device Stations), nt100-cc-ccs_4.csp (for four Remote Device Stations), nt100-cc-ccs_io_1.csp (for one Remote IO Station)
DeviceNet Slave	NT100_DN_DNS.EDS
EtherCAT Slave	Hilscher NT 100 RE ECS V4.6.xml
EtherNet/IP Adapter	HILSCHER NT 100-RE EIS V1.1.EDS
POWERLINK Controlled Node	00000044_NT100PLS-64O_64I.xdd 00000044_NT100PLS-512O_512I.xdd
PROFIBUS DP Slave	HIL_0C0E.GSD
PROFINET IO Device	GSDML-V2.35-HILSCHER-NT 100-RE PNS-YYYYMMDD.xml
Sercos Slave	SDDML#v3.0#Hilscher#NT_100_RE-FIXCFG_FSPIO#YYYY-MM-DD.xml with default settings only. <b>Note:</b> Use the SDDML export function in SYCON.net to create a suitable SDDML file.

*Table 6: Device description files for netTAP NT 100*

The device description files are used in the configuration software of the  
 master.



### 1.3.3 Documentation for netTAP

The following documentation overview gives information, for which items you can find further information in which manual.



**Note:**

Further information: All manuals listed in the overview below can be found in the Documentation directory on the DVD delivered, in the Adobe Acrobat® Reader format (PDF).

#### Basic documentation for netTAP NT 100

You always need the following documents:

Manual	Contents	Document name
User Manual	netTAP NT 100 Installation, Operation and Hardware	netTAP NT 100 - Gateway Devices UM xx EN.pdf (this manual)
User Manual	Software Installation Gateway Solutions	Software Installation - Gateway Solutions UM xx EN.pdf
Operating Instruction Manual	Configuration of Gateway and Proxy Devices netTAP, netBRICK and netLINK Step by step description of the configuration of the netTAP NT 100. Configuration of the netTAP NT 100 as EtherCAT Slave, EtherNet/IP Adapter, Open Modbus/TCP, POWERLINK Controlled Node, PROFINET IO-Device, Sercos Slave CANopen Slave, CC-Link Slave, DeviceNet Slave, PROFIBUS DP Slave, 3964R, ASCII, Modbus RTU Master or Slave respectively netSCRIPT.	Configuration of Gateway and Proxy Devices OI xx EN.pdf

Table 7: Basic documentation for netTAP NT 100

### netTAP NT 100 with EtherCAT Master

You need the following additional documents, if you use the protocol EtherCAT Master on the gateway device:

Manual	Contents	Document name
Operating Instruction Manual	DTM for EtherCAT Master devices	EtherCAT Master DTM OI xx EN.pdf
Operating Instruction Manual	Generic DTM for EtherCAT Slave devices	EtherCAT Generic Slave DTM OI xx EN.pdf

*Table 8: Additional Documentation for netTAP NT 100 with EtherCAT Master*

### netTAP NT 100 with EtherNet/IP Scanner

You need the following additional documents, if you use the protocol EtherNet/IP Scanner on the gateway device:

Manual	Contents	Document name
Operating Instruction Manual	DTM for EtherNet/IP Scanner devices	EtherNetIP Scanner DTM OI xx EN.pdf
Operating Instruction Manual	Generic DTM from EDS File EtherNet/IP Adapter Devices	EtherNetIP Generic Adapter DTM EDS OI xx EN.pdf
Operating Instruction Manual	Generic DTM for EtherNet/IP Adapter devices	EtherNetIP Generic Adapter DTM OI xx EN.pdf

*Table 9: Additional Documentation for netTAP NT 100 with EtherNet/IP Scanner*

### netTAP NT 100 with PROFINET IO-Controller

You need the following additional documents, if you use the protocol PROFINET IO-Controller on the gateway device:

Manual	Contents	Document name
Operating Instruction Manual	DTM for PROFINET IO-Controller devices	PROFINET IO Controller DTM OI xx EN.pdf
Operating Instruction Manual	Generic DTM for PROFINET IO-Device devices	PROFINET IO Generic Device DTM IO xx EN.pdf

*Table 10: Additional Documentation for netTAP NT 100 with PROFINET IO-Controller*

### netTAP NT 100 with Sercos Master

You need the following additional documents, if you use the protocol Sercos Master on the gateway device:

Manual	Contents	Document name
Operating Instruction Manual		
Operating Instruction Manual		

*Table 11: Additional Documentation for netTAP NT 100 with sercos Master*

### netTAP NT 100 with CANopen Master

You need the following additional documents, if you use the protocol CANopen Master on the gateway device:

Manual	Contents	Document name
Operating Instruction Manual	DTM for CANopen Master devices	CANopen Master DTM OI xx EN.pdf
Operating Instruction Manual	Generic DTM for CANopen Slave devices	CANopen Generic Slave DTM OI xx EN.pdf

*Table 12: Additional Documentation for netTAP NT 100 with CANopen Master*

### netTAP NT 100 with DeviceNet Master

You need the following additional documents, if you use the protocol DeviceNet Master on the gateway device:

Manual	Contents	Document name
Operating Instruction Manual	DTM for DeviceNet Master devices	DeviceNet Master DTM OI xx EN.pdf
Operating Instruction Manual	Generic DTM for DeviceNet Slave devices	DeviceNet Generic Slave DTM OI xx EN.pdf

*Table 13: Additional Documentation for netTAP NT 100 with DeviceNet Master*

### netTAP NT 100 with PROFIBUS DP Master

You need the following additional documents, if you use the protocol PROFIBUS DP Master on the gateway device:

Manual	Contents	Document name
Operating Instruction Manual	DTM for PROFIBUS DP Master devices	PROFIBUS DP Master DTM OI xx EN.pdf
Operating Instruction Manual	Generic DTM for PROFIBUS DP Slave devices	PROFIBUS DP Generic Slave DTM OI xx EN.pdf

*Table 14: Additional Documentation for netTAP NT 100 with PROFIBUS DP Master*

### netTAP NT 100 with netSCRIPT

You need the following additional documents, if you use the protocol netSCRIPT on the gateway device:

Manual	Contents	Document name
Operating Instruction Manual	netSCRIPT Programming Language for serial communication	netSCRIPT Programming Language for Serial Communication UM xx EN.pdf

*Table 15: Additional Documentation for netTAP NT 100 with netSCRIPT*

### netTAP NT 100 with ASCII

You need the following additional documents, if you use the protocol ASCII on the gateway device:

Manual	Contents	Document name
Application Note	ASCII Data Flow Control	ASCII Data Flow Control AN xx EN.pdf

*Table 16: Additional Documentation for netTAP NT 100 with ASCII*

### netTAP NT 100 with 3964R

You need the following additional documents, if you use the protocol 3964R on the gateway device:

Manual	Contents	Document name
Application Note	3964R Data Flow Control	3964R Data Flow Control AN xx EN.pdf

*Table 17: Additional Documentation for netTAP NT 100 with 3964R*

## 2 Safety

### 2.1 General note about safety

The user manual, the accompanying texts and the documentation are written for the use of the products by educated personnel. When using the products, all safety instructions and all valid legal regulations have to be obeyed. Technical knowledge is presumed. The user has to assure that all legal regulations are obeyed.

### 2.2 Intended use

Devices described in this manual are devices for communication and connect two communication networks. The NT 100 devices work as a gateway between these two networks.

NT 100-RE-XX	NT 100-DP-XX	NT 100-CO-XX	NT 100-DN-XX
NT 100-RE-CC	NT 100-DP-CC	NT 100-CO-CC	NT 100-DN-CC
NT 100-RE-CO	NT 100-DP-CO	NT 100-CO-CO	NT 100-DN-CO
NT 100-RE-DP	NT 100-DP-DN	NT 100-CO-DP	NT 100-DN-DP
NT 100-RE-DN	NT 100-DP-DP	NT 100-CO-DN	NT 100-DN-DN
NT 100-RE-RS	NT 100-DP-RS	NT 100-CO-RS	NT 100-DN-RS

Table 18: netTAP devices: NT 100

The netTAP NT 100 devices are in a compact housing and suitable for DIN rail mounting according to DIN EN 60715.

### 2.3 Personnel qualification

The netTAP NT 100 Gateway must only be installed, configured and removed by qualified personnel. Job-specific technical skills for people professionally working with electricity must be present concerning the following topics:

- Safety and health at work
- Mounting and attaching of electrical equipment
- Measurement and Analysis of electrical functions and systems
- Evaluation of the safety of electrical systems and equipment
- Installing and configuring IT systems

## 2.4 References safety

References safety:

[1] ANSI Z535.6-2006 American National Standard for Product Safety Information in Product Manuals, Instructions, and Other Collateral Materials

[2] IEC 60950-1, Information technology equipment - Safety - Part 1: General re-quirements, (IEC 60950-1:2005, modified); German Edition EN 60950-1:2006

[3] EN 61340-5-1 and EN 61340-5-2 as well as IEC 61340-5-1 and IEC 61340-5-2

## 2.5 Safety instructions to avoid personal injury

To ensure your own personal safety and to avoid personal injury, you necessarily must read, understand and follow the following safety instructions and all safety messages in this manual about danger causing personal injury, before you install and operate your netTAP NT 100 device.

### **Danger of unsafe system operation**

To prevent harm of persons, do not remove this device under runtime conditions before you can not guarantee further a safe and secure operation of the plant.

## 2.6 Safety instructions to avoid property damage

To avoid property damage respectively device destruction of the netTAP NT 100 device, you necessarily must read, understand and follow the following safety instructions and all safety messages in this manual about danger causing property damage, before you install and operate your netTAP NT 100 device.

### 2.6.1 Power disconnect during firmware or configuration download

If during the process of downloading a firmware or configuration

- the power supply to the device is interrupted, or
- the power supply to a PC with the software application is interrupted, or
- a reset to the device is done,

this may lead to the following consequences:

Loss of device parameters, firmware corruption

- The firmware download or the configuration download is interrupted and remains incomplete.
- The firmware or the configuration database will be corrupted and device parameters will be lost.
- Device damage may occur as the device cannot be rebooted.

Whether these consequences occur depends on when the power disconnect occurs during the download.

- During configuration download process, do not interrupt the power supply to the PC or to the device, and do not perform a reset!

Otherwise you might be forced to send in your device for repair.

#### **Power drop during write and delete accesses in the file system**

The FAT file system in the netX firmware is subject to certain limitations in its operation. Write and delete accesses in the file system (firmware update, configuration download etc.) can damage the FAT (File Allocation Table) if the accesses cannot be completed if the power drops. Without a proper FAT, a firmware may not be found and cannot be started.

Make sure that the power supply to the device is not interrupted during write and delete accesses in the file system (firmware update, configuration download, etc.).

## 2.6.2 Device destruction by exceeding allowed supply voltage

Adhere for all netTAP NT 100 device described in this manual the instruction hereafter:

The netTAP NT 100 may only be operated with the specified supply voltage. Make sure that the limits of the allowed range for the supply voltage are not exceeded. A supply voltage above the upper limit can cause severe damage to the netTAP NT 100! A supply voltage below the lower limit can cause malfunction in the netTAP NT 100. The allowed range for the supply voltage is defined by the tolerances specified in this manual.

The data on the mandatory supply voltage for the netTAP NT 100 device is documented in section *Requirements for operation* [▶ page 26]. There the required and permitted supply voltage for the netTAP NT 100 device is provided inclusively the permitted tolerance range.

## 2.6.3 Exceeding the maximum number of allowed write/delete accesses

This device uses a serial Flash chip for storing remanent data, such as firmware, configuration, etc. This chip allows a maximum of 100 000 write/delete accesses which is sufficient for a standard device operation. Writing/deleting the chip excessively (e.g. in order to change configuration or name of station) will exceed the maximum number of allowed write/delete accesses and, thus, result in damage to the device. If, e.g., the configuration is changed every hour, the maximum number will be reached after 11.5 years. If, e.g., it is changed every minute, the maximum number will already be reached after approx. 69 days.

Avoid exceeding the maximum number of allowed write/delete accesses by excessive writing.

## 2.6.4 Danger of unsafe system operation

To prevent property damage, do not remove this device under runtime conditions before you can not guarantee further a safe and secure operation of the plant.



## 2.7 Labeling of safety messages





Signal word	Meaning
 <b>DANGER</b>	Indicates a hazardous situation which, if not avoided, will result in death or serious injury.
 <b>WARNING</b>	Indicates a hazardous situation which, if not avoided, could result in death or serious injury.
 <b>CAUTION</b>	Indicates a hazardous situation which, if not avoided, may result in minor or moderate injury.
 <b>NOTICE</b>	Indicates a property damage message

Table 19: Signal words

## 3 Description and requirements

### 3.1 Brief description

The netTAP NT 100 devices described in this manual are communication devices and connect two communication networks. The netTAP devices act as a gateway between the two networks.

The netTAP NT 100 is a device with two interfaces (communication channels) whose operating principle is shown in the following figure.

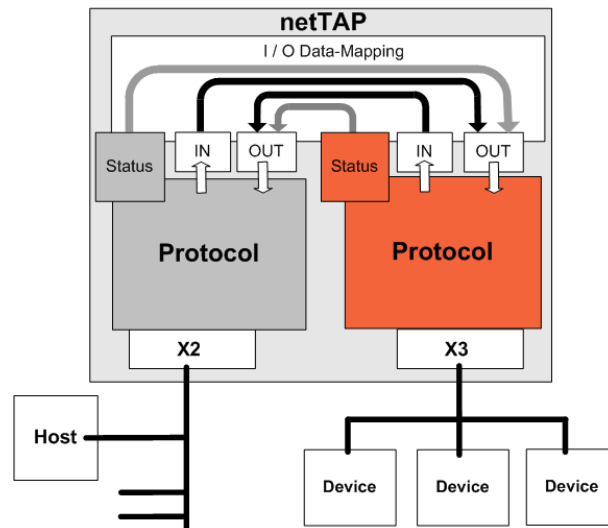

Figure 1: netTAP operating principle

The function of the device is determined by a loadable firmware and configuration.

Interface X2 is an Ethernet or a fieldbus interface, interface X3 is a fieldbus, an Ethernet or a serial interface. Connections X2 and X3 are accessible from the front of the device. In principle, hosts or field devices can be connected to X2 and X3.

Under the protective cover of the netTAP device, there is a USB interface for device configuration and diagnosis by a PC.

The netTAP devices are configured with the configuration and diagnosis program SYCON.net. The loadable firmware determines the gateway function. The operation of the configuration software SYCON.net is described in the Operating Instruction Manual *Configuration of Gateway and Proxy Devices*. You will find this manual in the document directory of the product DVD.

The firmware holds the cyclic send and receive data of the protocol on port X2 and the data of the protocol on port X3 in an internal memory of the device. Using the configuration software, the receive data of the protocol on port X2 can be mapped to the transmit data of the protocol on ports X3 and the receive data of the protocol on port X3 can be mapped to the transmit data of the protocol on ports X2.

Status information of the protocol on port X2 can be mapped to the transmit data of the protocol on port X3 and vice versa.

The firmware of the netTAP NT 100 with gateway function does not support the mapping of acyclic services/messages.

### 3.2 Device type name

The following figure shows an NT 100 RE-DP.

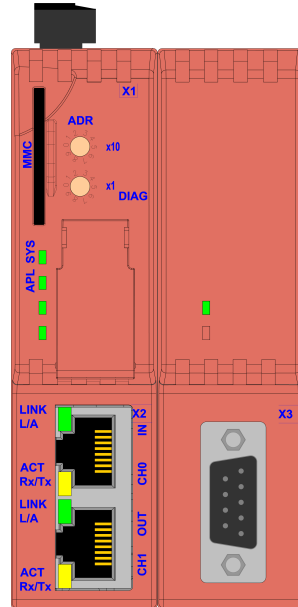

Figure 2: Device name NT 100-RE-DP

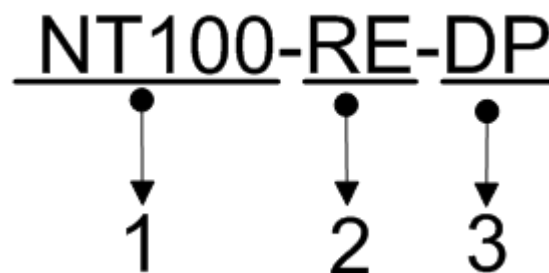

Figure 3: Device name (example)

The device description consists of the following parts:

1. Device type netTAP 100
2. Network to port X2 (left part of the device). In the example, RE stands for Real-Time Ethernet
3. Network to port X3 (right part of the device). In the example, DP stands for PROFIBUS

The following networks are supported (primary network on port X2):

Name	Network
CO	CANopen
DN	DeviceNet
DP	PROFIBUS DP
RE	Real-Time Ethernet (2* RJ45)

*Table 20: Network on port X2 (primary network)*

The following networks are supported (secondary network on connector X3):

Name	Network
CC	CC-Link
CO	CANopen
DN	DeviceNet
DP	PROFIBUS DP
RS	Serial (Modbus RTU, ASCII, 3964R or serial with netSCRIPT)

*Table 21: Network on port X3 (secondary network)*

## 3.3 Protocol conversions

### 3.3.1 Protocol conversion 1: Ethernet to Fieldbus

The netTAP device connects Ethernet (connector X2) and Fieldbus (connector X3). The following devices support that:

NT 100 device type	Protocol to X2	Protocol to X3	Firmware file	Firmware version
NT 100-RE-CC	EtherCAT Master	CC-Link Slave	NTECMCCS.NXF	2.0
	EtherCAT Slave	CC-Link Slave	NTECSCCS.NXF	
	EtherNet/IP Scanner	CC-Link Slave	NTEIMCCS.NXF	
	EtherNet/IP Adapter	CC-Link Slave	NTEISCCS.NXF	
	Open Modbus/TCP	CC-Link Slave	NTOMBCCS.NXF	
	POWERLINK Controlled Node	CC-Link Slave	NTPLSCCS.NXF	
	PROFINET IO-Controller	CC-Link Slave	NTPNMCCS.NXF	
	PROFINET IO-Device	CC-Link Slave	NTPNSCCS.NXF	
	Sercos Master	CC-Link Slave	NTS3MCCS.NXF	
	Sercos Slave	CC-Link Slave	NTS3SCCS.NXF	
NT 100-RE-CO	EtherCAT Master	CANopen Slave	NTECMCOS.NXF	2.0
	EtherCAT Slave	CANopen Master	NTECSCOM.NXF	
	EtherCAT Slave	CANopen Slave	NTECSCOS.NXF	
	EtherNet/IP Scanner	CANopen Slave	NTEIMCOS.NXF	
	EtherNet/IP Adapter	CANopen Master	NTEISCOM.NXF	
	EtherNet/IP Adapter	CANopen Slave	NTEISCOS.NXF	
	Open Modbus/TCP	CANopen Master	NTOMBCOM.NXF	
	Open Modbus/TCP	CANopen Slave	NTOMBCOS.NXF	
	POWERLINK Controlled Node	CANopen Master	NTPLSCOM.NXF	
	POWERLINK Controlled Node	CANopen Slave	NTPLSCOS.NXF	
	PROFINET IO-Controller	CANopen Slave	NTPNMCOS.NXF	
	PROFINET IO-Device	CANopen Master	NTPNSCOM.NXF	
	PROFINET IO-Device	CANopen Slave	NTPNSCOS.NXF	
	Sercos Master	CANopen Slave	NTS3MCOS.NXF	
	Sercos Slave	CANopen Master	NTS3SCOM.NXF	
Sercos Slave	CANopen Slave	NTS3SCOS.NXF		
NT 100-RE-DN	EtherCAT Master	DeviceNet Slave	NTECMDNS.NXF	2.0
	EtherCAT Slave	DeviceNet Master	NTECSDNM.NXF	
	EtherCAT Slave	DeviceNet Slave	NTECSDNS.NXF	
	EtherNet/IP Scanner	DeviceNet Slave	NTEIMDNS.NXF	
	EtherNet/IP Adapter	DeviceNet Master	NTEISDNM.NXF	
	EtherNet/IP Adapter	DeviceNet Slave	NTEISDNS.NXF	
	Open Modbus/TCP	DeviceNet Master	NTOMBDNM.NXF	
	Open Modbus/TCP	DeviceNet Slave	NTOMBDNS.NXF	
	POWERLINK Controlled Node	DeviceNet Master	NTPLSDNM.NXF	
	POWERLINK Controlled Node	DeviceNet Slave	NTPLSDNS.NXF	
	PROFINET IO-Controller	DeviceNet Slave	NTPNMDNS.NXF	
	PROFINET IO-Device	DeviceNet Master	NTPNSDNM.NXF	
	PROFINET IO-Device	DeviceNet Slave	NTPNSDNS.NXF	
	Sercos Master	DeviceNet Slave	NTS3MDNS.NXF	
	Sercos Slave	DeviceNet Master	NTS3SDNM.NXF	
Sercos Slave	DeviceNet Slave	NTS3SDNS.NXF		

NT 100 device type	Protocol to X2	Protocol to X3	Firmware file	Firmware version
NT 100-RE-DP	EtherCAT Master	PROFIBUS DP Slave	NTECMDPS.NXF	2.0
	EtherCAT Slave	PROFIBUS DP Master	NTECSDPM.NXF	
	EtherCAT Slave	PROFIBUS DP Slave	NTECSDPS.NXF	
	EtherNet/IP Scanner	PROFIBUS DP Slave	NTEIMDPS.NXF	
	EtherNet/IP Adapter	PROFIBUS DP Master	NTEISDPM.NXF	
	EtherNet/IP Adapter	PROFIBUS DP Slave	NTEISDPS.NXF	
	Open Modbus/TCP	PROFIBUS DP Master	NTOMBDPM.NXF	
	Open Modbus/TCP	PROFIBUS DP Slave	NTOMBDPS.NXF	
	POWERLINK Controlled Node	PROFIBUS DP Master	NTPLSDPM.NXF	
	POWERLINK Controlled Node	PROFIBUS DP Slave	NTPLSDPS.NXF	
	PROFINET IO-Controller	PROFIBUS DP Slave	NTPNMDPS.NXF	
	PROFINET IO-Device	PROFIBUS DP Master	NTPNSDPM.NXF	
	PROFINET IO-Device	PROFIBUS DP Slave	NTPNSDPS.NXF	
	Sercos Master	PROFIBUS DP Slave	NTS3MDPS.NXF	
	Sercos Slave	PROFIBUS DP Master	NTS3SDPM.NXF	
	Sercos Slave	PROFIBUS DP Slave	NTS3SDPS.NXF	

*Table 22: NT 100 for the conversion "Ethernet to Fieldbus"*

### 3.3.2 Protocol conversion 2: Ethernet to Serial

The netTAP device connects Ethernet (connector X2) and Serial (connector X3). The following devices support that:

NT 100 device type	Protocol to X2	Protocol to X3	Firmware file	Firmware version
NT 100-RE-RS	EtherCAT Master	3946R	NTECMNVR.NXF	2.0
	EtherCAT Master	ASCII	NTECMASC.NXF	
	EtherCAT Master	Modbus RTU Master/Slave	NTECMMBR.NXF	
	EtherCAT Master	Serial with netSCRIPT	NTECMNSC.NXF	
	EtherCAT Slave	3946R	NTECSNVR.NXF	
	EtherCAT Slave	ASCII	NTECSASC.NXF	
	EtherCAT Slave	Modbus RTU Master/Slave	NTECSMBR.NXF	
	EtherCAT Slave	Serial with netSCRIPT	NTECSNSC.NXF	
	EtherNet/IP Scanner	3946R	NTEIMNVR.NXF	
	EtherNet/IP Scanner	ASCII	NTEIMASC.NXF	
	EtherNet/IP Scanner	Modbus RTU Master/Slave	NTEIMMBR.NXF	
	EtherNet/IP Scanner	Serial with netSCRIPT	NTEIMNSC.NXF	
	EtherNet/IP Adapter	3946R	NTEISNVR.NXF	
	EtherNet/IP Adapter	ASCII	NTEISASC.NXF	
	EtherNet/IP Adapter	Modbus RTU Master/Slave	NTEISMBR.NXF	
	EtherNet/IP Adapter	Serial with netSCRIPT	NTEISNSC.NXF	
	Open Modbus/TCP	3946R	NTOMBNVR.NXF	
	Open Modbus/TCP	ASCII	NTOMBASC.NXF	
	Open Modbus/TCP	Modbus RTU Master/Slave	NTOMBMBR.NXF	
	Open Modbus/TCP	Serial with netSCRIPT	NTOMBNSC.NXF	
	POWERLINK Controlled Node	3946R	NTPLSNVR.NXF	
	POWERLINK Controlled Node	ASCII	NTPLSASC.NXF	
	POWERLINK Controlled Node	Modbus RTU Master/Slave	NTPLSMBR.NXF	
	POWERLINK Controlled Node	Serial with netSCRIPT	NTPLSNSC.NXF	
	PROFINET IO-Controller	3946R	NTPNMNVR.NXF	
	PROFINET IO-Controller	ASCII	NTPNMASC.NXF	
	PROFINET IO-Controller	Modbus RTU Master/Slave	NTPNMMBR.NXF	
	PROFINET IO-Controller	Serial with netSCRIPT	NTPNMNSC.NXF	
	PROFINET IO-Device	3946R	NTPNSNVR.NXF	
	PROFINET IO-Device	ASCII	NTPNSASC.NXF	
	PROFINET IO-Device	Modbus RTU Master/Slave	NTPNSMBR.NXF	
	PROFINET IO-Device	Serial with netSCRIPT	NTPNSNSC.NXF	
	Sercos Master	3946R	NTS3MNVR.NXF	
	Sercos Master	ASCII	NTS3MASC.NXF	
	Sercos Master	Modbus RTU Master/Slave	NTS3MMBR.NXF	
	Sercos Master	Serial with netSCRIPT	NTS3MNNSC.NXF	
	Sercos Slave	3946R	NTS3SNVR.NXF	
	Sercos Slave	ASCII	NTS3SASC.NXF	
	Sercos Slave	Modbus RTU Master/Slave	NTS3SMBR.NXF	
	Sercos Slave	Serial with netSCRIPT	NTS3SNSC.NXF	

Table 23: NT 100 for the conversion "Ethernet to Serial"

### 3.3.3 Protocol conversion 3: Fieldbus to Fieldbus

The netTAP device connects Fieldbus (connector X2) and Fieldbus (connector X3). The following devices support that:

NT 100 device type	Protocol to X2	Protocol to X3	Firmware file	Firmware version	
NT 100-CO-CC	CANopen Master	CC-Link Slave	NTCOMCCS.NXF	2.0	
	CANopen Slave	CC-Link Slave	NTCOSCCS.NXF		
NT 100-CO-CO	CANopen Master	CANopen Slave	NTCOMCOS.NXF		
	CANopen Slave	CANopen Master	NTCOSCOM.NXF		
	CANopen Slave	CANopen Slave	NTCOSCOS.NXF		
NT 100-CO-DN	CANopen Master	DeviceNet Slave	NTCOMDNS.NXF		
	CANopen Slave	DeviceNet Master	NTCOSDNM.NXF		
	CANopen Slave	DeviceNet Slave	NTCOSDNS.NXF		
NT 100-CO-DP	CANopen Master	PROFIBUS DP Slave	NTCOMDPS.NXF		
	CANopen Slave	PROFIBUS DP Master	NTCOSDPM.NXF		
	CANopen Slave	PROFIBUS DP Slave	NTCOSDPS.NXF		
NT 100-DP-CC	PROFIBUS DP Master	CC-Link Slave	NTDPMCCS.NXF		2.0
	PROFIBUS DP Slave	CC-Link Slave	NTDPSCCS.NXF		
NT 100-DP-CO	PROFIBUS DP Master	CANopen Slave	NTDPMCOS.NXF		
	PROFIBUS DP Slave	CANopen Master	NTDPSCOM.NXF		
	PROFIBUS DP Slave	CANopen Slave	NTDPSCOS.NXF		
NT 100-DP-DN	PROFIBUS DP Master	DeviceNet Slave	NTDPMDNS.NXF		
	PROFIBUS DP Slave	DeviceNet Master	NTDPSDNM.NXF		
	PROFIBUS DP Slave	DeviceNet Slave	NTDPSDNS.NXF		
NT 100-DP-DP	PROFIBUS DP Master	PROFIBUS DP Slave	NTDPMDPS.NXF		
	PROFIBUS DP Slave	PROFIBUS DP Master	NTDPSDPM.NXF		
	PROFIBUS DP Slave	PROFIBUS DP Slave	NTDPSDPS.NXF		
NT 100-DN-CC	DeviceNet Master	CC-Link Slave	NTDNMCCS.NXF	2.0	
	DeviceNet Slave	CC-Link Slave	NTDNSCCS.NXF		
NT 100-DN-CO	DeviceNet Master	CANopen Slave	NTDNMCOS.NXF		
	DeviceNet Slave	CANopen Master	NTDNSCOM.NXF		
	DeviceNet Slave	CANopen Slave	NTDNSCOS.NXF		
NT 100-DN-DN	DeviceNet Master	DeviceNet Slave	NTDNMDNS.NXF		
	DeviceNet Slave	DeviceNet Master	NTDNSDNM.NXF		
	DeviceNet Slave	DeviceNet Slave	NTDNSDNS.NXF		
NT 100-DN-DP	DeviceNet Master	PROFIBUS DP Slave	NTDNMDPS.NXF		
	DeviceNet Slave	PROFIBUS DP Master	NTDNSDPM.NXF		
	DeviceNet Slave	PROFIBUS DP Slave	NTDNSDPS.NXF		

Table 24: NT 100 for the conversion "Fieldbus to Fieldbus"



### 3.3.4 Protocol conversion 4: Fieldbus to Serial

The netTAP device connects Fieldbus (connector X2) and Serial (connector X3). The following devices support that:

NT 100 device type	Protocol to X2	Protocol to X3	Firmware file	Firmware version
NT 100-CO-RS	CANopen Master	3946R	NTCOMNVR.NXF	2.0
	CANopen Master	ASCII	NTCOMASC.NXF	
	CANopen Master	Modbus RTU Master/Slave	NTCOMMBR.NXF	
	CANopen Master	Serial with netSCRIPT	NTCOMNSC.NXF	
	CANopen Slave	3946R	NTCOSNVR.NXF	
	CANopen Slave	ASCII	NTCOSASC.NXF	
	CANopen Slave	Modbus RTU Master/Slave	NTCOSMBR.NXF	
	CANopen Slave	Serial with netSCRIPT	NTCOSNSC.NXF	
NT 100-DP-RS	PROFIBUS DP Master	3946R	NTDPMNVR.NXF	2.0
	PROFIBUS DP Master	ASCII	NTDPMASC.NXF	
	PROFIBUS DP Master	Modbus RTU Master/Slave	NTDPMMBR.NXF	
	PROFIBUS DP Master	Serial with netSCRIPT	NTDPMNSC.NXF	
	PROFIBUS DP Slave	Modbus RTU Master/Slave	NTDPSMBR.NXF	
	PROFIBUS DP Slave	3946R	NTDPSNVR.NXF	
	PROFIBUS DP Slave	ASCII	NTDPSASC.NXF	
	PROFIBUS DP Slave	Serial with netSCRIPT	NTDPSNSC.NXF	
NT 100-DN-RS	DeviceNet Master	3946R	NTDNMNVR.NXF	2.0
	DeviceNet Master	ASCII	NTDNMASC.NXF	
	DeviceNet Master	Modbus RTU Master/Slave	NTDNMMBR.NXF	
	DeviceNet Master	Serial with netSCRIPT	NTDNMNSC.NXF	
	DeviceNet Slave	3946R	NTDNSNVR.NXF	
	DeviceNet Slave	ASCII	NTDNSASC.NXF	
	DeviceNet Slave	Modbus RTU Master/Slave	NTDNSMBR.NXF	
	DeviceNet Slave	Serial with netSCRIPT	NTDNSNSC.NXF	

Table 25: NT 100 for the conversion "Fieldbus to Serial"

## 3.4 Requirements

### 3.4.1 Requirements for operation

Mount the netTAP device on a DIN rail.

An external power supply is required. The voltage must be within the permissible range of 24 V DC  $\pm$  6 V DC. The power supply must provide at least 130 mA (at 24 V).

Power is supplied via connector X1.

---

**NOTICE****Device damage**

The supply voltage must not exceed 30 V, otherwise damage to the device is possible.

---

The permissible temperature range must be observed for operation.

For a correct operation of the netTAP, the following additional requirements must be met:

1. A suitable firmware must have been loaded into the device.
2. The netTAP must have been configured with SYCON.net without errors.

### 3.4.2 Configuration software requirements

- PC with 1 GHz processor or higher
- Windows® 7 (32-bit and 64-bit) SP1, Windows® 8 (32-bit and 64-bit), Windows® 8.1 (32-bit and 64-bit), Windows® 10 (32-bit and 64-bit)
- Administrator rights are required for installation
- Internet Explorer 5.5 or higher
- RAM: At least 512 MB, recommended 1024 MB
- Free hard disk space: Approx. 400 MB
- Resolution: At least 1024 x 768 pixels
- Keyboard and mouse
- USB
- Restriction: Touch screen is not supported

**Note:**

- If the project file is used on another PC,
- this PC must also meet the system requirements listed above,
  - the device description files of the devices used in the project must be imported into the configuration software SYCON.net on the new PC, and
  - the DTMs of the devices used in the project must also be installed on this additional PC.
-

## 3.5 Licenses

For using a firmware with master functionality, the netTAP device must have a master license . To read out and display whether the device has a master license, use the software SYCON.net.

**Note:**

To read out whether the device has a master license, a firmware must be loaded in the device. The base firmware is not sufficient for this purpose. The operating instruction manual *Gateway and Proxy Device Configuration OI xx EN.pdf* describes how to load a firmware into the device and how to read out whether the device contains a master license.

---

The master license can be ordered subsequently and transferred into the device using the software SYCON.net. Use SYCON.net to read the necessary ordering data from the device and to prepare the order.

The order name of the master license is: NXLIC-MASTER, part number: 8211.000

## 4 Device drawings and connectors

### 4.1 Dimensional drawings

Provide sufficient headroom to allow the removal of the power supply connector from above.

The power supply plug is included within the delivery. As a spare part, the plug can be ordered from RIA connect GmbH in 78176 Blumberg; part number: 31369102-001792.

### 4.2 Device label

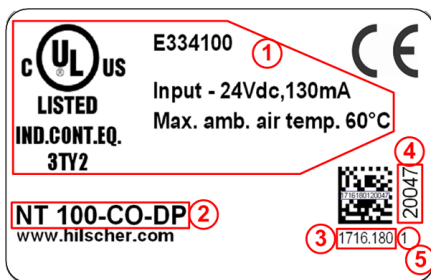

- (1) UL certification data, see <http://www.ul.com>
- (2) Device type name
- (3) Part number
- (4) Serial number
- (5) Hardware revision

Table 26: Device label

### 4.3 LEDs and control elements

#### 4.3.1 LEDs and control elements of the upper half of the device

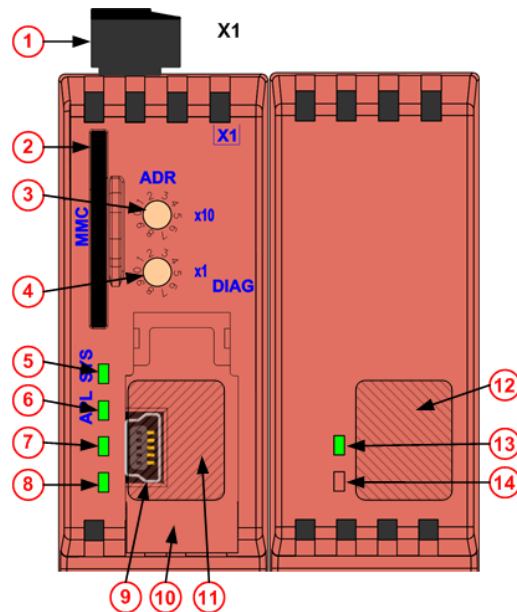

Figure 4: LEDs and control elements (upper half of the device)

Pos.	Description	
(1)	Connector X1, power supply	
(2)	Slot for SD/MMC memory card (article number of SD card: 1719.003)	
(3)	Address switch, factor 10.	From SYCON.net version 1.351, the address switches can be activated and from firmware version 1.5 they can be used for PROFIBUS DP slave, DeviceNet slave, CANopen slave, and CC-Link slave. SYCON.net serves to configure whether the address switches are active for X2 or X3 . Section <i>Value range of the address switches</i> [► page 31] describes the value range for each protocol.
(4)	Address switch, factor 1.	
(5)	SYS LED	
(6)	APL LED	
(7)	LED, meaning depends on the protocol at X2.	
(8)	LED, meaning depends on the protocol at X2.	
(9)	Mini-USB connector under the cover flap	
(10)	Cover flap for mini-USB connector	
(11)	Position for protocol-dependent label for the protocol at connector X2 on the cover flap of the USB connector.	
(12)	Position for protocol-dependent label for the protocol at connector X3.	
(13)	LED, meaning depends on the protocol at X3.	
(14)	LED, meaning depends on the protocol at X3.	

Table 27: LEDs and control elements (upper half of the device)

### 4.3.1.1 Value range of the address switches

The following tables for PROFIBUS DP slave, DeviceNet slave, CANopen slave and CC-Link slave specify the value range of the address switches.

Protocol	Valid range of values
PROFIBUS DP Slave	0 ... 99 (station address)
DeviceNet Slave	0 ... 63 (MAC ID)
CANopen Slave	0 ... 99 (node address)

Table 28: Value range of the address switches

Protocol	Valid range of values	Number of stations	
CC-Link Slave	1 ... 64	1	The number of stations depends on the configuration.
	1 ... 63	2	
	1 ... 62	3	
	1 ... 61	4	

Table 29: Value range of the address switches (CC-Link slave)

### 4.3.2 LEDs of the lower half of the device

The lower half of the device has no control elements. Device type NT 100-RE-XX (real-time Ethernet) has LEDs at connector X2 on the left side. The meaning of the LEDs depends on the protocol.

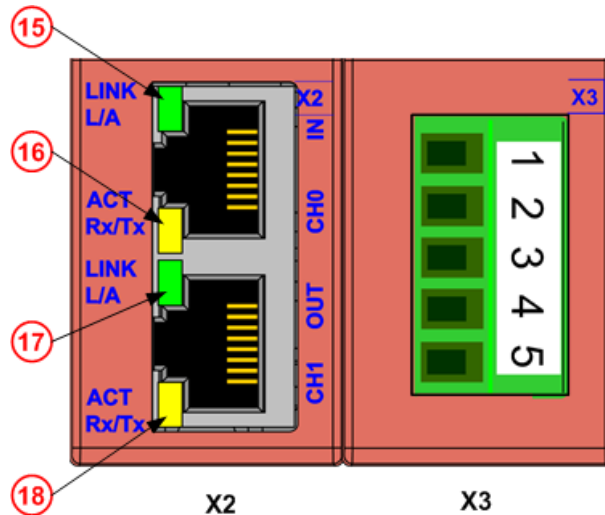

Figure 5: LEDs (lower half of the device)

Pos.	Description
(15)	LINK LED (link) / L/A LED (link and activity) on channel 0 at X2, green.
(16)	ACT LED (activity) / Rx/Tx LED (activity) on channel 0 at X2, yellow.
(17)	LINK LED (link) / L/A LED (link and activity) on channel 1 at X2, green.
(18)	ACT LED (activity) / Rx/Tx LED (activity) on channel 1 at X2, yellow.

Table 30: LEDs (lower half of the device)

### 4.4 Device drawings: Left side (connector X2)

The figures in the following table show the left side of a netTAP device with connector X2.

NT 100-RE-XX	NT 100-DP-XX	NT 100-CO-XX	NT 100-DN-XX
X2 2*RJ45 socket	X2 D-Sub socket, 9-pin	X2 D-Sub plug, 9-pin	Mini-COMBICON, 5-pin
Included in device:			
NT100-RE-DP NT100-RE-CO NT100-RE-DN NT100-RE-RS NT100-RE-CC	NT100-DP-DP NT100-DP-CO NT100-DP-DN NT100-DP-RS NT100-DP-CC	NT100-CO-DP NT100-CO-CO NT100-CO-DN NT100-CO-RS NT100-CO-CC	NT100-DN-DP NT100-DN-CO NT100-DN-DN NT100-DN-RS NT100-DN-CC

Table 31: Device drawings (left side, X2)

LED label for Real-Time Ethernet (NT 100-RE-XX):

PROFINET	EtherCAT	EtherNet/IP	Sercos	Open Modbus	POWERLINK
SF BF	RUN ERR	MS NS	STA ERR	RUN ERR	BS BE

Table 32: LED label (Real-Time Ethernet)

The LED stickers are included within the delivery. Apply the LED sticker according to the firmware loaded.



### 4.5 Device drawings: Right side (connector X3)

The figures in the following table show the right side of a netTAP device with connector X3.

NT 100-XX-DP	NT 100-XX-CO	NT 100-XX-RS	NT 100-XX-DN	NT 100-XX-CC
X3: D-Sub socket, 9-pin	X3: D-Sub plug, 9-pin	X3: D-Sub plug, 9-pin	X3: COMBICON , 5-pin	X3: COMBICON , 5-pin
Included in device:				
NT100-RE-DP	NT100-RE-CO	NT100-RE-RS	NT100-RE-DN	NT100-RE-CC
NT100-DP-DP	NT100-DP-CO	NT100-DP-RS	NT100-DP-DN	NT100-DP-CC
NT100-CO-DP	NT100-CO-CO	NT100-CO-RS	NT100-CO-DN	NT100-CO-CC
NT100-DN-DP	NT100-DN-CO	NT100-DN-RS	NT100-DN-DN	NT100-DN-CC

Table 33: Device drawings (right side, X3)

## 4.6 Connectors and interfaces

### 4.6.1 X1 power supply

The netTAP devices are supplied via connector X1. The supply voltage must be between 18 V and 30 V DC. The plug is included within the delivery.

Power supply	Pin	Signal	Description
 Mini Combicon	1	0 V / GND	GND of the power supply, 4 * 10 nF against PE
	2	+24 V DC	+24 V DC power supply

Table 34: Power supply

### 4.6.2 X2/X3 Front connectors

#### 4.6.2.1 X2/X3 PROFIBUS interface

The PROFIBUS (X2/X3) is designed as an RS-485 interface according to the PROFIBUS standard EN 50170.

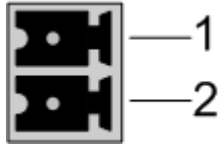
PROFIBUS	Pin	Signal	Description
 D-Sub socket, 9-pin	3	Rx/Tx+	Receive/send data, positive
	4	CNTR-P	Control signal for repeater (direction control)
	5	ISO_GND	Data reference potential
	6	VP	Voltage for terminating resistor 5 V, max. current: 100 mA
	8	Rx/Tx	Receive/transmit data, negative
	Shield	PE	Metal shell

Table 35: PROFIBUS interface (RS-485)

Inside the device, a pull-up resistor of 100 kΩ is connected to "Rx/Tx+".

Inside the device, a pull-down resistor of 100 kΩ is connected to "Rx/Tx-".

### 4.6.2.2 X2/X3 CANopen interface

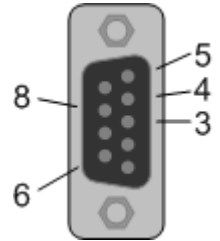
The CANopen interface X2/X3 is designed as an ISO 11898 interface according to the CANopen CiA DS 102 standard.

CANopen	Pin	Signal	Description
 <p>D-Sub plug, 9-pin</p>	2	CAN L	CAN_L bus line
	3	ISO_GND	CAN reference potential
	7	CAN H	CAN_H bus line
	1, 4, 5, 6, 8, 9	-	<b>Important note and strongly recommended:</b> Leave these pins unconnected! Otherwise there is a high risk of a device damage.
	Shield	PE	Metal shell on PE

Table 36: CANopen interface (ISO 11898)

### 4.6.2.3 X2/X3 DeviceNet interface

The DeviceNet interface X2/X3 is designed according to the DeviceNet standard.

DeviceNet	Pin	Signal	Description
 <p>COMBICON socket</p>	1	ISO GND	DeviceNet reference potential, 15 nF against PE
	2	CAN L	CAN Low signal
	3	Drain	Shield, 15 nF against PE
	4	CAN H	CAN High signal
	5	V+	+24 V DeviceNet power supply

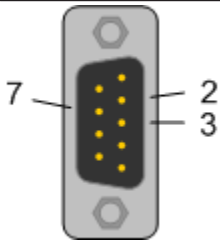
Table 37: DeviceNet interface

### 4.6.2.4 X2 Ethernet interface

For the Ethernet interface, use RJ45 plug and a twisted pair cable of category 5 (CAT5), or higher, which consists of 4 pairs of twisted wires with a max. baud rate of 100 MBit/s (CAT5).

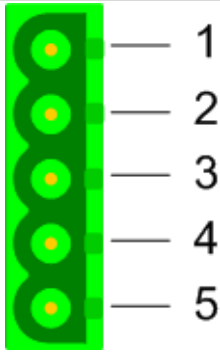

**Note:**

The device supports the Auto Crossover function and can therefore switch RX and TX. The following figure shows the RJ45 standard pin assignment.

Ethernet	Pin	Signal	Description
<p>RJ-45 socket</p>	1	TX+	Transmit data positive
	2	TX-	Transmit data negative
	3	RX+	Receive data positive
	4	-	Connected and terminated to PE via RC combination*
	5	-	Connected and terminated to PE via RC combination*
	6	RX-	Receive data negative
	7	-	Connected and terminated to PE via RC combination*
	8	-	Connected and terminated to PE via RC combination*
	-	PE	Metal shell on PE
	-	-	* Bob Smith Termination

Table 38: RJ45 Ethernet interface

### 4.6.2.5 X3 CC-Link interface

CC-Link	Pin	Signal	Description
<p>COMBICON socket</p>	1	DA	Data positive
	2	DB	Data negative
	3	DG	Data ground, on ISO_GND, 3.3 nF against PE
	4	SLD	Shield, pin 4 and 5 are internally connected
	5	FG	Field ground, pin 4 und 5 are internally connected to PE

Table 39: CC-Link interface

4.6.2.6 X3 Serial interface – RS-232 / RS-422 / RS-485

The configuration of the serial interface determines whether X3 is an RS-232, RS-422 or RS-485 interface.

RS-232	Pin	Signal	Description
 <p>D-Sub plug, 9-pin</p>	2	RxD	Receive data
	3	TxD	Transmit data
	5	ISO_GND	Reference potential
	7	RTS	Request to send
	8	CTS	Clear to send
	Shield	PE	Metal shell on PE

Table 40: RS-232 interface

RS-422	Pin	Signal	Description
 <p>D-Sub plug, 9-pin</p>	1	RxD -	Receive data negative
	4	TxD +	Send data positive
	5	ISO_GND	Reference potential
	6	RxD +	Receive data positive
	9	TxD -	Send data negative
	Shield	PE	Metal shell on PE

Table 41: RS-422 interface

RS-485	Pin	Signal	Description
 <p>D-Sub plug, 9-pin</p>	1	RxD/TxD-	Receive/transmit data, negative
	5	ISO_GND	Reference potential
	6	RxD/TxD+	Receive/send data, positive
	Shield	PE	Metal shell on PE

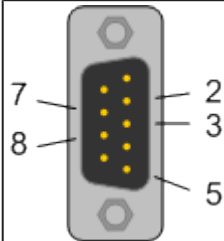
Table 42: RS-485 interface

### 4.6.2.7 Termination for RS-422 and RS-485

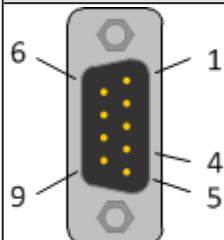
The sliding switch (S3) on the backside of NT 100-XX-RS devices serves to activate or deactivate the termination.

Switch S3	Description
 <p>Switch in position On (up).</p>	<p>Switch up: <b>On</b></p> <p>Termination switched on with 220 Ohm termination resistor for RS-422 between RxD+ and RxD- or for RS-485 between RxD/TxD+ and RxD/TxD- and 390 Ohm pull-up/pulldown resistor.</p>
	<p>Switch down: <b>Off</b></p> <p>Termination switched off.</p>

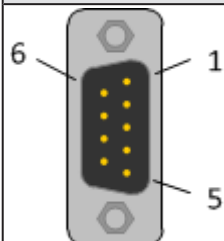
Table 43: Termination for RS-422 and RS-485

The following figure shows the RS-485 termination of the device.

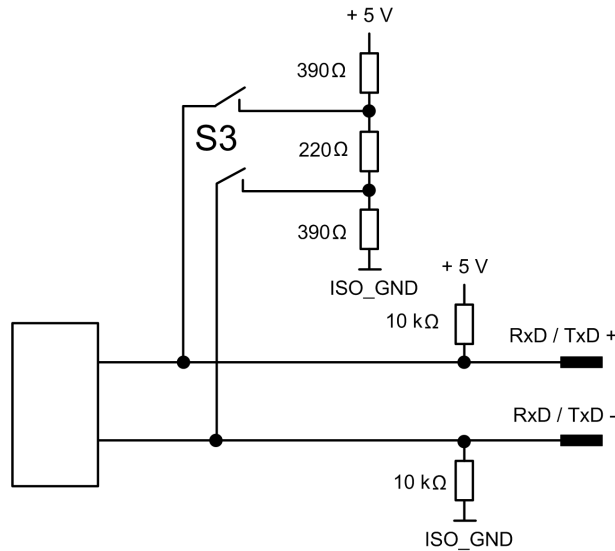

Figure 6: RS-485 termination

With the RS-422 interface, the termination shown above exists only at the RxD lines.

### 4.6.3 Diagnostic interface (Mini-B USB)

The USB interface serves configuration and diagnostic purposes.

USB	Pin	Signal	Description
 <p>Mini-B USB 5-ping</p>	1	n.c.	-
	2	D-	Data-
	3	D+	Data+
	4	ID	-
	5	GND	Reference potential
	Shield	PE	Metal shell on PE

Table 44: USB interface (Mini-B)

## 4.7 Schematic diagrams - Galvanic Isolation

The following schematic diagrams show the connection between the different connectors of the device and enable you to properly integrate the device in accordance with the potential equalization and shielding concept of your plant.

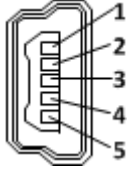

**Note:**

The PE (potential equalization) of the device is connected via the DIN rail.

### 4.7.1 Galvanic isolation in case of NT 100-RE-XX devices

The following figure is valid for the devices NT 100-RE-CC, NT 100-RE-CO, NT 100-RE-DP, NT 100-RE-DN, and NT 100-RE-RS.

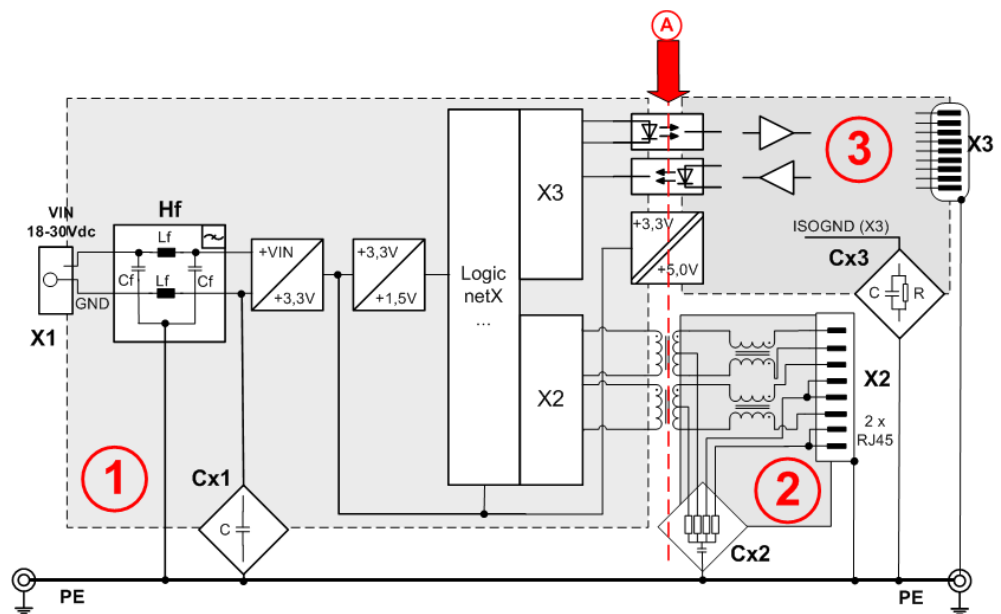

Figure 7: Galvanic isolation in case of NT 100-RE-XX devices

The device has three galvanically isolated areas. Arrow (A) shows the isolation to the connectors X2 and X3.

Area	Description
(1)	System area, galvanically coupled with power supply connector X1.
(2)	Ethernet connecting area X2: 2 * RJ45. The figure shows only one RJ45 socket. The second RJ45 socket is built up identically and connected to the logic (area X2).
(3)	Fieldbus connecting area X3: D-Sub-plug/socket or COMBICON connector.

Table 45: Areas

The following table shows the data of the galvanic isolation and coupling against PE.

Pos.	Connector	Galvanic isolation	Coupling against PE	Shield connection against PE
X1 (1)	-	no	Cx1: 4 * 10 nF 500 V HF: Cf = 10 nF, Lf = 47 µH	-
X2 (2)	Ethernet	inductive	Cx2: 4 * 75 Ω, 1 nF 2000 V	directly via the metal connection of RJ-45 sockets
X3 (3)	CC-Link	inductive	Cx3: 3.3 nF 63 V	directly
	CANopen	optical	Cx3: 1 MΩ parallel to 15 nF 1000 V	directly
	PROFIBUS DP	inductive	Cx3: 1 MΩ parallel to 2.2 nF 1000 V	directly
	DeviceNet	optical	Cx3: 1 MΩ parallel to 15 nF 1000 V	1 MΩ parallel to 15 nF 1000 V
	RS-232/422/485	optical	Cx3: 1 MΩ parallel to 15 nF 1000V parallel to 10 nF 500 V	directly

Table 46: Coupling of NT 100-RE-XX devices



### 4.7.2 Galvanic isolation in case of NT 100-DP-XX, NT 100-CO-XX, and NT 100-DN-XX devices

The following figure is valid for the devices

- NT 100-DP-CC, NT 100-DP-CO, NT 100-DP-DN, NT 100-DP-DP, NT 100-DP-RS,
- NT 100-CO-CC, NT 100-CO-CO, NT 100-CO-DP, NT 100-CO-DN, NT 100-CO-RS,
- NT 100-DN-CC, NT 100-DN-CO, NT 100-DN-DP, NT 100-DN-DN, NT 100-DN-RS.,

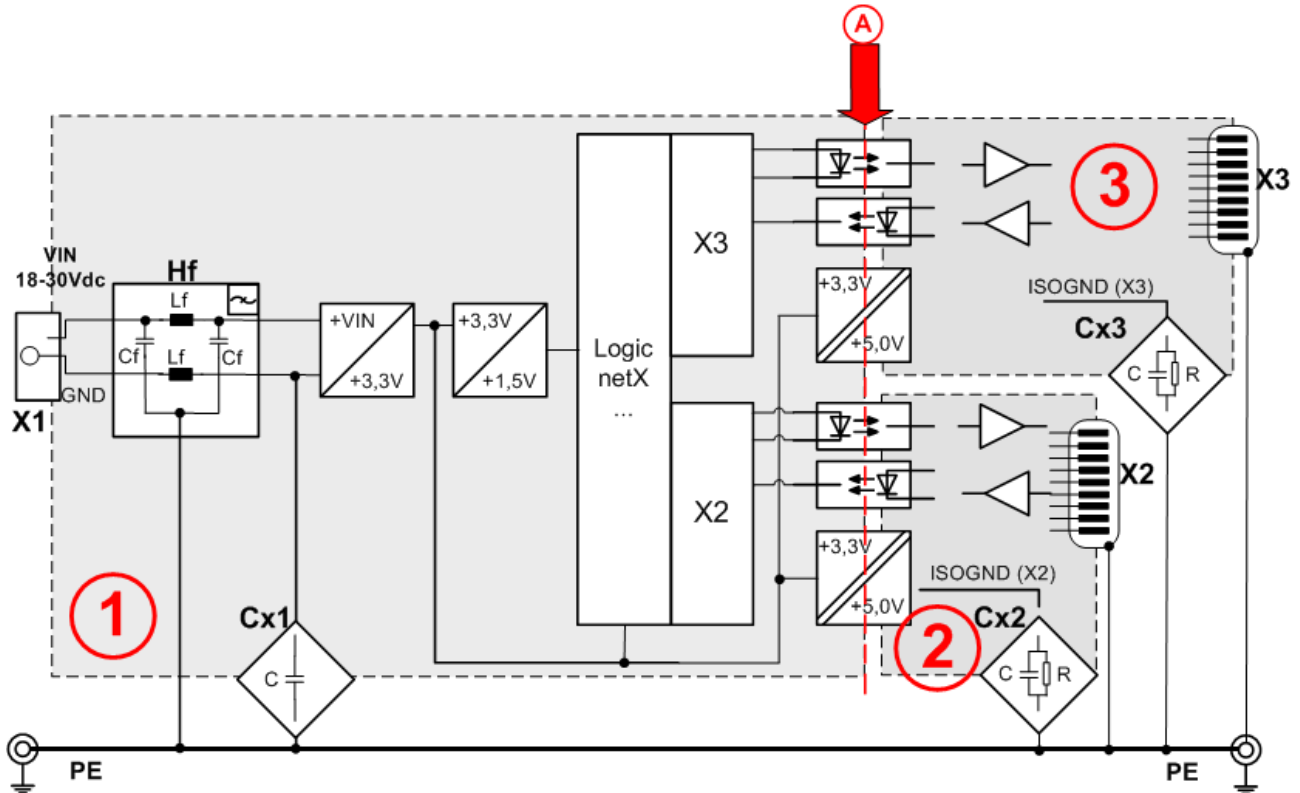

Figure 8: Galvanic isolation NT 100-DP-XX / NT 100-CO-XX / NT 100-DN-XX devices

The device has three galvanically isolated areas. Arrow (A) shows the isolation to the connectors X2 and X3.

Area	Description
(1)	System area, galvanically coupled with power supply connector X1.
(2)	Fieldbus connecting area X2: D-Sub-plug/socket or COMBICON connector.
(3)	Fieldbus connecting area X3: D-Sub-plug/socket or COMBICON connector.

Table 47: Areas

The following table shows the data of the galvanic isolation and coupling against PE.

Pos.	Connector	Galvanic isolation	Coupling against PE	Shield connection against PE
X1 (1)	-	no	Cx1: 4 * 10 nF 500 V	-
			HF: Cf = 10 nF, Lf = 47 µH	
X2 (2)	CANopen	optical	Cx2: 1 MΩ parallel to 15 nF 1000 V	directly
	DeviceNet	optical	Cx2: 1 MΩ parallel to 15 nF 1000 V	1 MΩ parallel to 15 nF 1000 V
	PROFIBUS DP	inductive	Cx2: 1 MΩ parallel to 2.2 nF 1000 V	directly
X3 (3)	CC-Link	inductive	Cx3: 3.3 nF 63 V	directly
	CANopen	optical	Cx3: 1 MΩ parallel to 15 nF 1000 V	directly
	DeviceNet	optical	Cx3: 1 MΩ parallel to 15 nF 1000 V	1 MΩ parallel to 15 nF 1000 V
	PROFIBUS DP	inductive	Cx3: 1 MΩ parallel to 2.2 nF 1000 V	directly
	RS-232/422/485	optical	Cx3: 1 MΩ parallel to 15 nF 1000V parallel to 10 nF 500 V	directly

Table 48: Galvanic isolation NT 100-DP-XX / NT 100-CO-XX / NT 100-DN-XX devices

## 5 NT 100 mounting and dismounting

### 5.1 Mounting instructions

The devices can be mounted side-by-side without any gap. On the top side, the devices should have a minimum distance of 20 mm to the next device.

The air ventilation slots of the device must not be covered by any objects.

#### NOTICE

Please pay attention to the grounding concept and shielding concept of the plant. The concept should prevent that a compensating current flows via signal and power supply lines between the used devices. Otherwise a device destruction is possible.

### 5.2 DIN top hat rail mounting of the NT 100

Mount the top hat rail according to DIN EN 60715 for the netTAP device horizontally at the intended location. The DIN top hat rail has to be connected with the potential equalization conductor (PE).

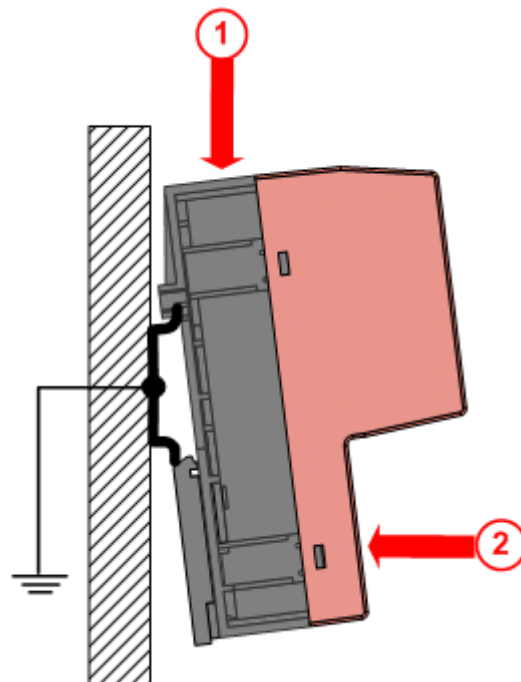

Figure 9: Mounting the NT 100

- Push the device onto the top hat rail from above (1).
- Then press the device against the mounting surface, according to arrow (2).
- Afterwards connect the 24 V supply voltage to the device.

Grounding is done via a grounding contact located at the backside of the device connecting it electrically to the DIN top hat rail.

## 5.3 Dismounting the NT 100 from the DIN top hat rail

In order to dismount the netTAP from the DIN Top Hat Rail, first remove the power supply cable and all data cables from the device.

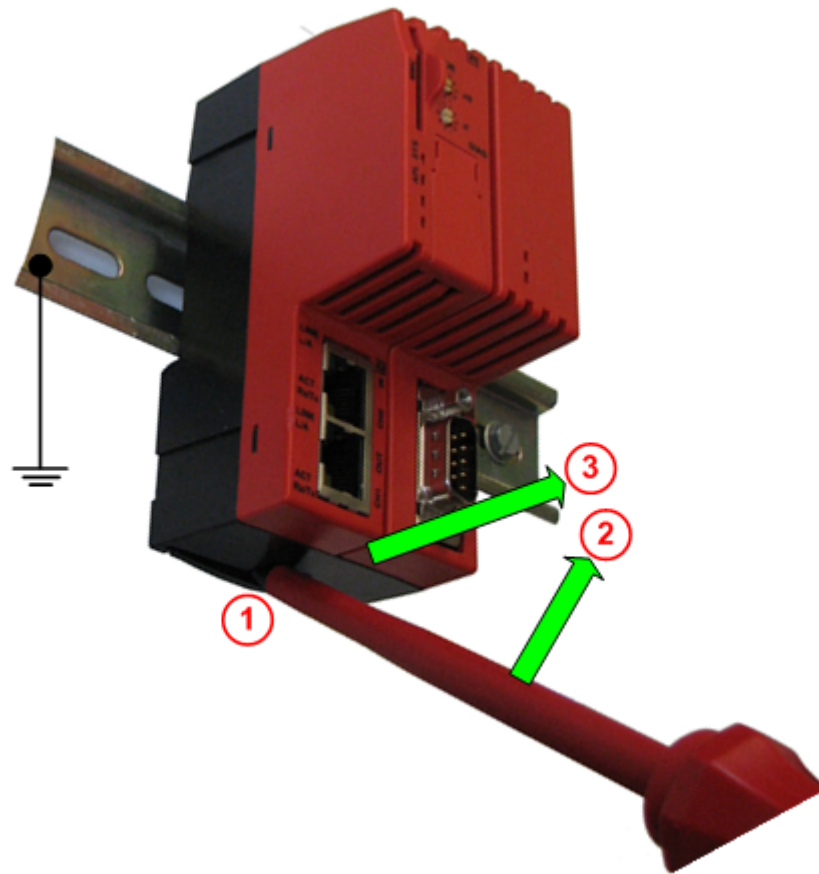

Figure 10: Dismounting the NT 100 device from the DIN top hat rail

- To release the device from the DIN top hat rail, use a screw driver, which you put at the clip (1) in the center of the device.
- Slightly press the screw driver in direction of arrow (2).
- ⇒ The lock at the DIN top hat rail is released.
- You can then easily pull the device off the DIN top hat rail in direction of arrow (3).

## 6 Installing the driver

For installing the USB driver, use the installation program `Gateways_setup.exe` on the Gateway Solution DVD in the main directory. The program checks whether the USB driver is installed or not.

At first, install the USB driver before you connect a netTAP device to the USB port of the PC for the first time.

## 7 Commissioning

### 7.1 Load firmware and configuration

The device is delivered without loaded firmware and without configuration. For commissioning it is necessary to load using the configuration software SYCON.net a firmware and a configuration into the device.

#### 7.1.1 Download configuration files with the PC

Proceed as follows:

1. Create and save the configuration on a standard PC using the configuration software SYCON.net.
2. First, download the firmware via a USB connection into the device. The firmware has to be downloaded only once.
3. Afterwards, download the configuration via the USB connection into the device. Download the configuration again after each change.

The firmware and configuration is stored in a non-volatile memory in the device and will be available after each power on.

A step by step description is in the operating instruction manual Configuration of Gateway and Proxy Devices.

#### 7.1.2 Transfer configuration using a memory card

##### 7.1.2.1 Prerequisite for memory cards

###### **Prerequisites**

1. A memory card with a maximum capacity of 2 GByte can be used.
2. The memory card has to be formatted in FAT format. The FAT12/16/32 formats are supported. The exFAT format is not supported.
3. Memory cards of the type MMC or SD card can be used. Additional prerequisites apply to use any SD card, which are described below.

###### **Prerequisites to use any SD card**

Any SD cards can only be used if **both** of the following prerequisites are fulfilled:

1. Firmware version 1.5.10.0 or higher has to be used in the device.
2. The following devices can be used with any MMC and SD card for saving and recovering the device:
  - NT 100-RE-XX with serial number 24906 and higher,
  - NT 100-DP-XX with serial number 21473 and higher,
  - NT 100-DN-XX with serial number 20283 and higher as well as
  - NT 100-CO-XX with serial number 20148 and higher.

Only the SD card which can be ordered from Hilscher (part number 1719.003) can be used reliable with devices that have a lower serial number.

### 7.1.2.2 Steps to transfer configuration files from memory card

Using a memory card makes it possible to load the same configuration (and firmware) into several devices without using a PC. At first a PC and software SYCON.net is necessary to prepare the memory card.

1. Create and save the configuration on a standard PC using the software SYCON.net.
2. Transfer the configuration from the PC via a USB connection into the device.
3. Insert an empty but formatted memory card into the memory card slot of the netTAP device until it snaps in.
4. Use SYCON.net to copy the firmware and configuration inside the netTAP device to the memory card.
5. Remove the memory card from the device.
6. Insert this memory card into the memory card slot (labeled MMC) of the new device. This device continues its operation with the firmware and configuration, which is stored in the device in the non-volatile Flash memory.
7. Remove the power supply from the device.
8. Reconnect the power supply. After return of power the files from the memory card are copied into the non-volatile Flash memory of the device (this operation takes a moment) and then the device starts with it.
9. Remove the memory card from the device to have a faster start of the device for the next power on, because the copy operation is not done.

## 7.2 Start-up behavior

The start-up behavior of the device depends on the fact, whether at the time of return of power supply a memory card is inserted in the device or not.

### 7.2.1 Start-up without memory card

After return of power supply the configuration data are loaded into the device internal memory. Depending on the amount of stored configuration data this can last for some seconds (approx. 4 s).

### 7.2.2 Start-up with memory card

This section describes the take-over of the configuration data from memory card.



---

**Important:**

Two parameters are displayed in SYCON.net software for the start behavior in case of repowering the device and memory card present in the slot of the device. Only the **Start-up Options** parameter **Restore automatically** with setting "Every start" has to be used!

The **start-up Options** parameter **Restore automatically** with the setting **If different** is not supported by the netTAP firmware and results in the situation that no files from the memory card are transferred into the device. However it is possible to copy the files from memory card to the device with SYCON.net software (manually).

---

The following description refers to the parameter start behavior **Every Start** of the memory card.

- Remove power supply from the netTAP NT 100 device.
- Insert memory card with until it snaps in.
- Supply 24 V operation voltage to the device.
- ⇒ The SYS LED indicates a quick alternating between green and yellow for approx. 8 s. During this time the memory card can be removed from the device to prevent the data transfer.
- ⇒ Afterwards the files were transferred from the memory card into the non-volatile flash memory of the device. This operation takes (typically) up to 1 minute. With large configuration files (especially netSCRIPT files) this time can be exceeded. During this operation the SYS LED is yellow.
- ⇒ After the copy operation the device starts with the new configuration.

It is possible to load the same configuration from one memory card into several devices without using a PC.



## 7.2.3 Reset device to factory settings with memory card

Using a memory card that has the basic firmware stored on it, the netTAP NT 100 device can be set back to factory settings.

### Create a memory card

In order to do so, copy from the directory of the DVD

```
Supplements & Examples\Device Recovery\netTAP 100 Factory Settings  
\Recovery via Memory Card\
```

the file STARTUP.INI and the directory BACKUP (including all subdirectories) into the root directory of an empty memory card.

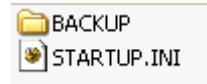

Figure 11: Files for factory settings

### Proceed as follows

- Insert the memory card with basic firmware until it snaps in.
- Insert the memory card with basic firmware until it snaps in.
- Supply 24 V operation voltage to the device.
- The device loads the firmware while the SYS-LED indicates the following states: Quick alternating between green and yellow (for approx. 8 s), then solid yellow (for approx. 10 s), then switched off for a short time and finally solid green.
- ⇒ Afterwards the device is reset to factory settings.

Subsequently the device needs to be configured by the software SYCON.net using a PC. The configuration steps are described in document Configuration of Gateway and Proxy Devices.

## 7.2.4 Boot-up behaviour on invalid firmware

If after the power up cycle the LED SYS (Pos. (5) in section *LEDs and control elements* [▶ page 30] ) yellow / green with approx. 1 Hz, the firmware of the device is invalid or has been destroyed. In this case there is no further access possible with the configuration tool SYCON.net. The device has fallen back into boot loader mode.

The device has to be recovered to the factory default settings.

### 7.2.4.1 Recover to factory default settings via USB

The following devices are recoverable via USB:

- NT 100-RE-XX serial number 20888 and above.
- NT 100-DP-XX serial number 20397 and above.
- NT 100-DN-XX serial number 20145 and above.
- NT 100-CO-XX serial number 20060 and above.

Devices with serial numbers below cannot be updated via USB and are remaining recoverable with memory card only. See section *Gerät mit Speicherkarte auf Werkseinstellung zurücksetzen* [▶ page 49] .

In case there is no further communication possible via and the configuration tool SYCON.net because a firmware download has failed for example, then a special recovery procedure can bring back the device back to life.

In this special state the LED SYS (Pos. (5) in section *LEDs and control elements* [▶ page 30] ) yellow / green with approx. 1 Hz.

In case a NT 100 device is connected in this very special state to the USB port of a PC, windows will ask for a new USB driver, even if you have already installed it before. Please follow the instructions in the section *Installation des USB-Treibers für den "Hilscher netX boot monitor"* [▶ page 51] .

Just in the case that no driver installation is requested (cause the device has been previously connected in this state before already) please follow the in-structions in the section *Firmware Laden* [▶ page 54] .

## 7.2.4.2 USB driver installation in boot loader mode as „Hilscher netX boot monitor“

**Note:**

The following section only need to be done in case of an error, if the firm-ware download into the devices was not completed without error. (Loss of power or line interruption during the firmware download).

After establishing the USB cable connection and powering the device, windows will ask you for the USB driver with the following window:



Figure 12: USB installation - Step 1

- Insert the DVD included in the delivery into the DVD drive of your PC.
- Select **No, not this time (1)** . Afterwards click **Next (2)** .
- The following window will be opened.

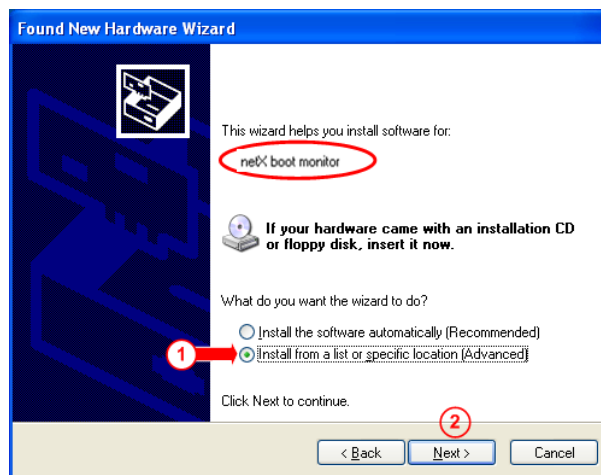

Figure 13: USB installation - Step 2

- Select **Install from a list or specific location (1)** and then click **Next (2)** .

➤ The following window will be opened.

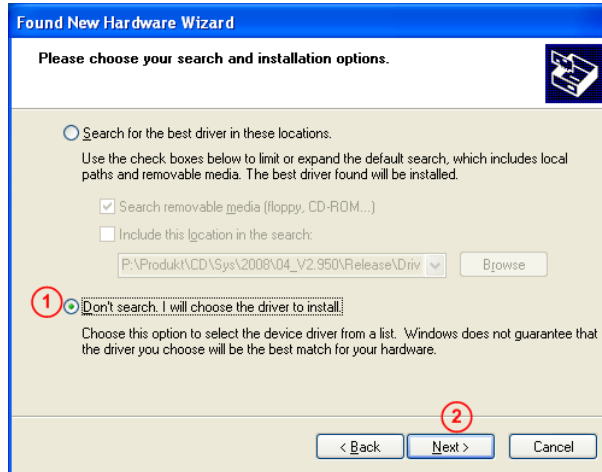

Figure 14: USB installation - Step 3

➤ Select **Don't search** (1) and then click **Next** (2) .

➤ The following window will be opened.

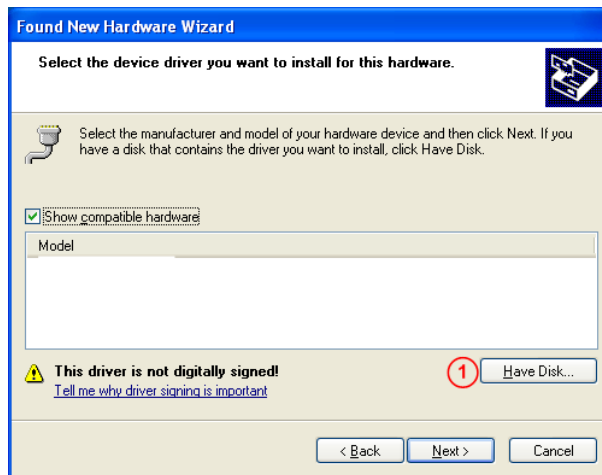

Figure 15: USB installation - Step 4

➤ Select **Have Disk** (1) .

➤ The following window will be opened.

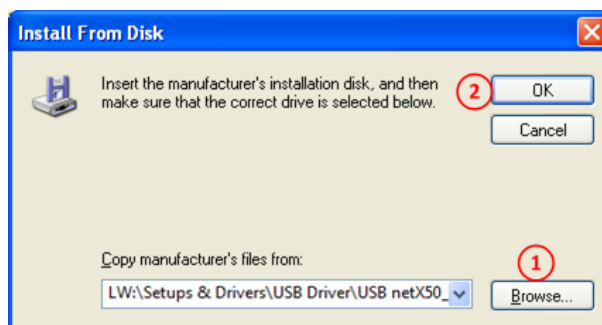

Figure 16: USB installation - Step 5

➤ Select **Browse** (1) .

- In the opening file explorer move to the DVD folder  
Setups & Drivers\USB Driver\USB netX50\_51\_52 and  
netX100  
and select the file netX\_usb\_cdc.inf.
- After returning to this window, click **OK (2)**.
- You will return back to the following window.

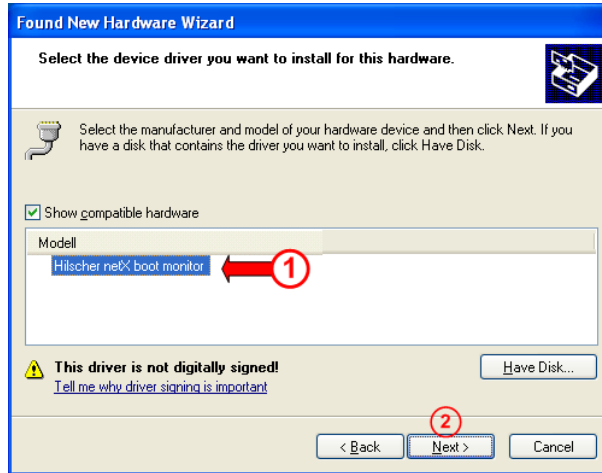

Figure 17: USB installation - Step 6

- Select **Hilscher netX boot monitor (1)** (even if there are other entries shown, please select this one) and click **Next (2)**.
- The following window will be opened.



Figure 18: USB Installation Schritt 7

- Click **Continue Anyway (1)**.
- Wait until the driver has been installed.
- Continue with section *Firmware Laden* [▶ page 54].

### 7.2.4.3 Loading firmware

- Start directly from the DVD Supplements & Examples\Device Recovery\netTAP 100 Factory Settings\Recovery via USB \comproX.exe .
- Alternatively, copy all files from Supplements & Examples\Device Recovery\netTAP 100 Factory Settings\Recovery via USB onto your PC and then start comproX.exe.
- The following window will be opened.

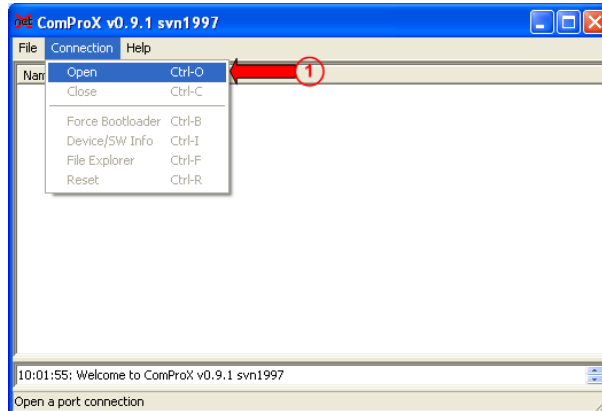

Figure 19: ComProX Start

- Select the drop down menu **Connection > Open (1)**.
- The following window will be opened.

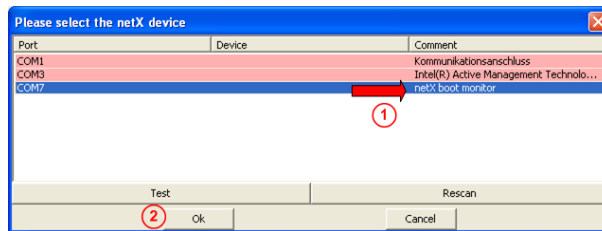

Figure 20: ComProX select connection

- Click **netX boot monitor (1)** and confirm with **OK (2)**.
- You are forwarded to the program's start screen.

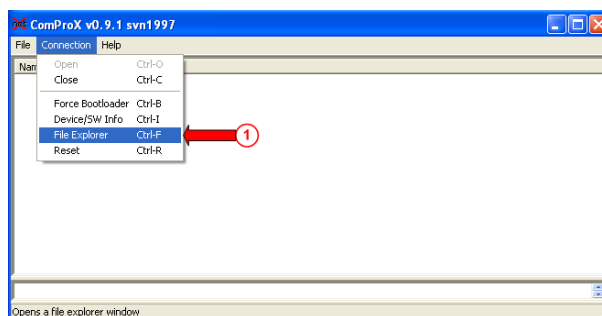

Figure 21: ComProX File Explorer

- Select now from the drop down menu **Connection > File Explorer (1)**.
- The following additional windows will be opened.

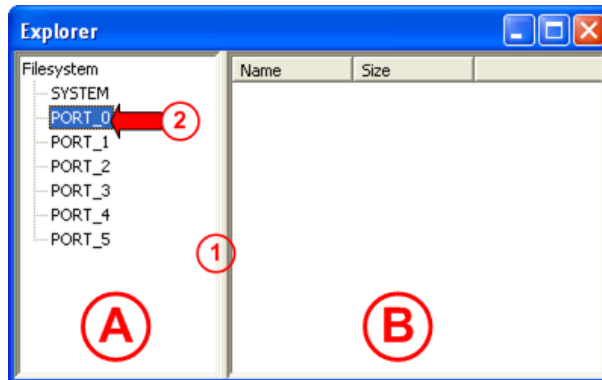

Figure 22: ComProX File Explorer, NT 100 file structure

- In order to see the file system of the device in the window area (A) move the dividing line (1) slightly to the right.
- Select in the window area (A) the entry **PORT\_0 (2)**. Then do a right mouse click afterwards in the window area (B).
- The following dialog menu will be opened.

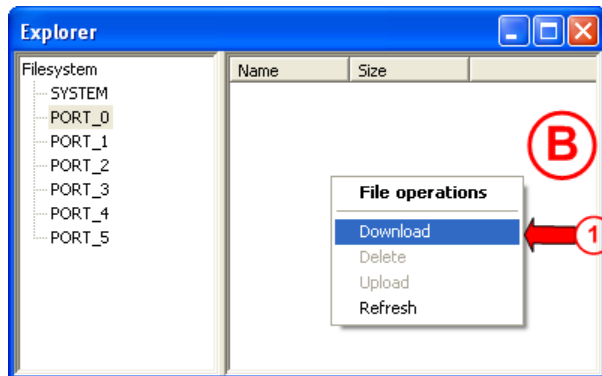

Figure 23: ComProX File Explorer, file menu 1

- Select **Download (1)**.
- The standard file explorer of your windows will be opened.
- Move on the DVD to folder  
Supplements & Examples\Device Recovery\netTAP 100  
Factory Settings\Recovery via USB  
file NTBASEFW.NXF. Click **Open**.
- Loading the firmware may take some seconds.
- Right mouse click into the window area (B).

➤ The following dialog menu will be opened.

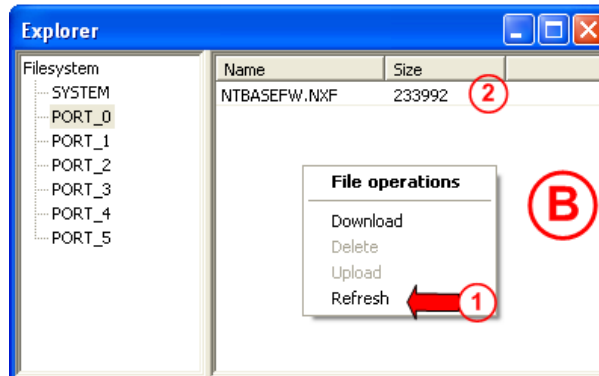

Figure 24: ComProX File Explorer, file menu 2

- Select **Refresh (1)**.
- In case the download was successful ComProX will show the downloaded firmware as shown at (2).
- Close the window above and close the main window of ComProX.
- Remove the power from your device and perform a power cycle.
- ⇒ The device will be restarted and the firmware will be started. Now the LED SYS (Pos. (5) in section *LEDs and control elements* [▶ page 30]) will be on green and the LED APL (Pos. (6)) blinks red.

The reset to factory settings has successfully been executed. Now you can access to the device again with the configuration tool SYCON.net via the USB port. From there you can now download the firmware of your choice.



# 8 Troubleshooting

## 8.1 Troubleshooting tips

Two methods for troubleshooting exist:

- The visual analysis of the LED conditions of the device.
- The analysis via the USB port along with the configuration tool SYCON.net.

The following overview describes the error conditions that may be detected by a visual check of the LEDs.

To determine the position of the LEDs use the device drawings in section *LEDs and control elements* [▶ page 30]. The number in the LED state column shows the position of the LED in the device drawing.







LED status	Remedy
No LED is on	The device is not powered or the device has a malfunction and needs replacement.
SYS LED (5) blinks   yellow/green with 1 Hz	After a power cycle the device has not found a valid firmware and remains in boot loader mode. The device has to be recovered and set back to factory setting. Follow section "Gerät mit Speicherkarte auf Werkseinstellung zurücksetzen" !!!.
SYS LED (5) on  yellow	The device has a malfunction and needs replacement.
SYS LED (5) on  green, APL LED (6) on  red blinking or  on red.	The device is well initialized. Further analysis is possible with the APL LED (6). See section APL !!!.
APL LED (6) blinks  green	The communication via port X2 or/and port X3 is not in data exchange mode. See section LED APL auf Seite 67 !!!.

Table 49: NT 100 troubleshooting

The device is operational just in case the illustrated error conditions do not met. Further protocol specific error diagnostics via the LEDs is possible by reading on the chapter *LEDs* [▶ page 59].

In deep diagnostics is possible at any time via the USB diagnostic port of the device and a PC with the software SYCON.net.

In case of trouble you should make sure that you have downloaded a correct signal mapping to the device via SYCON.net.

For some protocols it is necessary to synchronize data via a handshake between the gateway and the superordinated PLC. Please make sure that the handshake mechanism is kept.

## 8.2 Failure in 10 MBit/s half-duplex mode and workaround

Only older devices of device type NT 100-RE-xx are affected, which have a serial number below 20356.

Device type NT 100-RE-EN is not affected.

### **Affected hardware**

Hardware with the communication controller netX 50, netX 100 or netX 500; netX/Internal PHYs.

### **When can this Failure occur?**

When using standard Ethernet communication with 10 MBit/s half duplex mode, the PHY gets stuck in case of network collisions. Then no further network communication is possible. Only device power cycling allows Ethernet communication again.

This problem can only occur with Ethernet TCP/UDP IP, EtherNet/IP or Modbus TCP protocols when using hubs at 10 MBit/s. The issue described above is not applicable for protocols which use 100 MBit/s or full duplex mode.

### **Solution / Workaround:**

Do not use 10 MBit/s-only hubs. Use either switches or 10/100 MBit/s Dual Speed hubs, to make sure the netX Ethernet ports are connected with 100 MBit/s or in full duplex mode.

This erratum is fixed with all components of the 'Y' charge (9 digit charge number shows 'Y' at position 5 (nnnnYnnnn)).

### **Reference**

"Summary of 10BT problem on EthernetPHY",

RenesasElectronics Europe, April 27, 2010

## 9 LEDs

### 9.1 SYS

This LED indicates important operating states (without configuration of the device)







LED	Color	State	Description
SYS	Duo LED yellow/green		
Number in the device drawing (5)	 (green)	On	Device is initialized. Further diagnosis, see APL LED.
	 (yellow)	On	Firmware and configuration files are loaded. The duration of this state depends from the size of the firmware and configuration files. This can take one minute and longer. Remains the LED yellow permanently, then a hardware failure is possible.
	 (yellow)	Blinking	The device does not work. In the connected USB cable, Pin 4 has a connection to ground. <ul style="list-style-type: none"> <li>Remove the USB cable from the device. Disconnect the power supply from the device.</li> <li>Reconnect the power supply to the device. After some seconds reconnect the USB cable to the device.</li> <li>The device is working.</li> </ul>
	 (yellow/green)	Blinking yellow/green 1 Hz	Error: Boot loader is active. STARTUP.INI file is missing. No communication via USB with SYCON.net is possible. A memory card with the files for factory setting on it is necessary to make the device operational. To prepare a memory card, see section <i>Reset device to factory settings with memory card</i> [▶ page 49].
	 (yellow/green)	Blinking yellow/green 16 Hz	Waiting period (appr. 8 sec, adjustable) before copying the firmware and configuration files from the memory card into the Flash memory.
	 (off)	Off	Power supply for the device is missing or hardware failure.

Table 50: LED states System LED

To determine the position of the SYS LED use the device drawings in section *LEDs and control elements* [▶ page 30].

## 9.2 APL

The following table describes the APL LED.







LED	Color	State	Meaning
APL	<b>Duo LED red/green</b>		
	 (green)	On	The communication at X2 and X3 is in cyclic data exchange and the gateway function is performed.
	 (green)	Blinking (1 Hz, 1 x, 2 s off)	The device is initialized, but the communication at X2 is not in cyclic data exchange.
	 (green)	Blinking (1 Hz, 2 x, 2 s off)	The device is initialized, but the communication at X3 is not in cyclic data exchange.
	 (red)	Blinking (1 Hz, 1 x, 2 s off)	The device is initialized, but the configuration for the communication protocol at X2 is missing or the communication contains an error.
	 (red)	Blinking (1 Hz, 2 x, 2 s aus)	The device is initialized, but the configuration for the communication protocol at X3 is missing or the communication contains an error.
	 (red)	On	The device has detected an error during the initialization: Missing configuration, error in configuration or internal error.
 (gray)	Off	The device is not in operation.	

Table 51: APL LED states

LED state	Definition
Blinking (1 Hz, 1 x, 2 s off)	The indicator blinks 1 x (500 ms) followed by a long "off" phase (2,000 ms).
Blinking (1 Hz, 2 x, 2 s off)	The indicator blinks 2 x (each 500 ms), separated by a short off phase (500 ms). The sequence is finished by a long off phase (2,000 ms).

Table 52: APL LED state definitions

To determine the position of the LED use the device drawings in section *LEDs and control elements* [▶ page 30].

## 9.3 LEDs Real-Time Ethernet systems

### 9.3.1 LEDs EtherCAT Master

The following table describes the LEDs for EtherCAT Master.

LED	Color	State	Description
<b>RUN</b>	<b>Duo LED red/green</b>		
	● (off)	Off	<b>INIT:</b> The device is in INIT state.
	☀ (green)	Blinking (2.5 Hz)	<b>PRE-OPERATIONAL:</b> The device is in PRE-OPERATIONAL state.
	☀ (green)	Flickering (10 Hz)	The device is not configured.
	☀ (green)	Single flash	<b>SAFE-OPERATIONAL:</b> The device is in SAFE-OPERATIONAL state.
	● (green)	On	<b>OPERATIONAL:</b> The device is in the OPERATIONAL state.
<b>ERR</b>	<b>Duo LED red/green</b>		
	● (off)	Off	Master has no errors
	☀ (red)	Single flash	Bus Sync error threshold
	☀ (red)	Double flash	Internal Stop of the bus cycle
	☀ (red)	Triple Flash	DPM watchdog has expired.
	☀ (red)	Quadruple Flash	No Master license present in the device.
	☀ (red)	Blinking (2.5 Hz)	Error in the configuration database.
	☀ (red)	Single Flickering	Channel Init was executed at the Master. Transient state that may not be visible.
	☀ (red)	Double Flickering	Slave is missing Unconfigured slave No matching mandatory slave list No bus connected
	☀ (red)	Flickering (10 Hz)	Boot-up was stopped due to an error.
<b>LINK</b>	<b>LED green</b>		
	● (green)	On	<b>Link:</b> The device is linked to the Ethernet, but does not send/receive Ethernet frames.
	☀ (green)	Flickering (load dependent)	<b>Activity:</b> The device is linked to the Ethernet and sends/receives Ethernet frames.
	● (off)	Off	The device has no link to the Ethernet.
<b>ACT</b>	<b>LED yellow</b>		
	● (off)	Off	This LED is not used.

Table 53: LED states for the EtherCAT Master (V4) protocol

LED state	Definition
Single flash	The LED shows one short flash (200 ms) followed by a long "Off" phase (1,000 ms).
Double flash	The LED shows a sequence of two short flashes (each 200 ms), separated by a short "Off" phase (200 ms). The sequence is finished by a long "Off" phase (1,000 ms).
Triple Flash	The LED shows a sequence of three short flashes (each 200 ms), separated by a short "Off" phase (200 ms). The sequence is finished by a long "Off" phase (1,000 ms).
Quadruple Flash	The LED shows a sequence of four short flashes (each 200 ms), separated by a short "Off" phase (200 ms). The sequence is finished by a long "Off" phase (1,000 ms).
Blinking (2.5 Hz)	The LED turns on and off with a frequency of 2.5 Hz: "On" for 200 ms, followed by "Off" for 200 ms.
Single Flickering	The LED is switched on and off once: "On" for 50 ms, followed by "Off" for 500 ms.
Double Flickering	The LED is switched on and off and on once: "On" / "Off" / "On" each for approximately 50 ms, followed by "Off" for 500 ms.
Flickering (10 Hz)	The LED turns on and off with a frequency of 10 Hz: "On" for 50 ms, followed by "Off" for 50 ms.
Flickering (load dependent)	The LED turns on and off with a frequency of approximately 10 Hz to indicate high Ethernet activity: "On" for approximately 50 ms, followed by "Off" for 50 ms. The LED turns on and off in irregular intervals to indicate low Ethernet activity.

Table 54: LED state definitions for the EtherCAT Master (V4) protocol

To determine the position of the LEDs use the device drawings in section *LEDs and control elements* [► page 30].

### 9.3.2 LEDs EtherCAT Slave

The following table describes the LEDs for EtherCAT Slave.

LED	Color	State	Description
<b>RUN</b>	<b>Duo LED red/green</b>		
	● (off)	Off	<b>INIT:</b> The device is in INIT state.
	☀ (green)	Blinking (2.5 Hz)	<b>PRE-OPERATIONAL:</b> The device is in PRE-OPERATIONAL state.
	☀ (green)	Single flash	<b>SAFE-OPERATIONAL:</b> The device is in SAFE-OPERATIONAL state.
	● (green)	On	<b>OPERATIONAL:</b> The device is in the OPERATIONAL state.
<b>ERR</b>	<b>Duo LED red/green</b>		
	● (off)	Off	<b>No error:</b> The EtherCAT communication of the device is in working condition.
	☀ (red)	Blinking (2.5 Hz)	<b>Invalid configuration:</b> General Configuration Error Possible reason: State change commanded by master is impossible due to register or object settings.
	☀ (red)	Single flash	<b>Local error:</b> Slave device application has changed the EtherCAT state autonomously. Possible reason 1: A host watchdog timeout has occurred. Possible reason 2: Synchronization Error, device enters Safe-Operational automatically.
	☀ (red)	Double flash	<b>Application watchdog timeout:</b> An application watchdog timeout has occurred. Possible reason: Sync Manager Watchdog timeout.
<b>L/A IN, L/A OUT</b>	<b>LED green</b>		
	● (green)	On	<b>Link:</b> The device is linked to the Ethernet, but does not send/receive Ethernet frames.
	☀ (green)	Flickering (load dependent)	<b>Activity:</b> The device is linked to the Ethernet and sends/receives Ethernet frames.
	● (off)	Off	The device has no link to the Ethernet.
	<b>LED yellow</b>		
	● (off)	Off	This LED is not used.

Table 55: LED states for the EtherCAT Slave protocol

LED state	Definition
Blinking (2.5 Hz)	The LED turns on and off with a frequency of 2.5 Hz: "On" for 200 ms, followed by "Off" for 200 ms.
Single flash	The LED shows one short flash (200 ms) followed by a long "Off" phase (1,000 ms).
Double flash	The LED shows a sequence of two short flashes (each 200 ms), separated by a short "Off" phase (200 ms). The sequence is finished by a long "Off" phase (1,000 ms).
Flickering (load dependent)	The LED turns on and off with a frequency of approximately 10 Hz to indicate high Ethernet activity: "On" for approximately 50 ms, followed by "Off" for 50 ms. The LED turns on and off in irregular intervals to indicate low Ethernet activity.

Table 56: LED state definitions for the EtherCAT Slave protocol

To determine the position of the LEDs use the device drawings in section *LEDs and control elements* [▶ page 30].

### 9.3.3 LEDs EtherNet/IP Scanner

The following table describes the LEDs for EtherNet/IP Scanner.

















LED	Color	State	Description
<b>MS</b> (module status)	<b>Duo LED red/green</b>		
	 (green)	On	<b>Device operational:</b> The device is operating correctly.
	 (green)	Flashing (1 Hz)	<b>Standby:</b> The device has not been configured.
	 (green/red/green)	Flashing green/red/green	<b>Self-test:</b> The device performs a self-test after power-on. The following sequence is displayed during the self-test: <ul style="list-style-type: none"> <li>• NS-LED off.</li> <li>• MS LED turns green for approximately 250 ms, turns red for approximately 250 ms, and again turns green (and holds that state until the power-up test has completed).</li> <li>• NS LED turns green for approximately 250 ms, turns red for approximately 250 ms, and then turns off (and holds that state until the power-up test has completed).</li> </ul>
	 (red)	Flashing (1 Hz)	<b>Major recoverable fault:</b> The device has detected a major recoverable fault. E.g., an incorrect or inconsistent configuration can be considered a major recoverable fault.
	 (red)	On	<b>Major unrecoverable fault:</b> The device has detected a major unrecoverable fault.
	 (off)	(Off)	<b>No power:</b> The device is powered off.
<b>NS</b> (Network status)	<b>Duo LED red/green</b>		
	 (green)	On	<b>Connected:</b> An IP address is configured, at least one CIP connection (any transport class) is established, and an Exclusive Owner connection has not timed out.
	 (green)	Flashing (1 Hz)	<b>No connections:</b> An IP address is configured, but no CIP connections are established, and an Exclusive Owner connection has not timed out.
	 (green/red/off)	Flashing green/red/off	<b>Self-test:</b> The device performs a self-test after power-on. Refer to the description of the MS LED in the self-test status.
	 (red)	Flashing (1 Hz)	<b>Connection timeout:</b> An IP address is configured, and an Exclusive Owner connection for which this device is the target has timed out.  The NS LED returns to steady green only when all timed out Exclusive Owner connections are reestablished.
	 (red)	On	<b>Duplicate IP:</b> The device has detected that its IP address is already in use.
 (off)	Off	<b>Not powered, no IP address:</b> The device does not have an IP address (or is powered off).	
<b>LINK</b>	<b>LED green</b>		
	 (green)	On	The device is linked to the Ethernet.
	 (off)	Off	The device has no link to the Ethernet.
<b>ACT</b>	<b>LED yellow</b>		
	 (yellow)	Flickering (load dependent)	The device sends/receives Ethernet frames.
	 (off)	Off	The device does not send/receive Ethernet frames.

Table 57: LED states for the EtherNet/IP Scanner protocol



LED state	Definition
Flashing (1 Hz)	The LED turns on and off with a frequency of 1 Hz: "On" for 500 ms, followed by "Off" for 500 ms.
Flashing fast green/red/green	The MS LED or NS LED turns on green "On" for 250 ms, then red "On" for 250 ms, then green "On" (until the test is completed).
Flickering (load dependent)	The LED turns on and off with a frequency of approximately 10 Hz to indicate high Ethernet activity: "On" for approximately 50 ms, followed by "Off" for 50 ms. The LED turns on and off in irregular intervals to indicate low Ethernet activity

*Table 58: LED state definitions for the EtherNet/IP Scanner protocol*

To determine the position of the LEDs use the device drawings in section *LEDs and control elements* [▶ page 30].

### 9.3.4 LEDs EtherNet/IP Adapter

The following table describes the LEDs for EtherNet/IP Adapter.

















LED	Color	State	Description
<b>MS</b> (module status)	<b>Duo LED red/green</b>		
	 (green)	On	<b>Device operational:</b> The device is operating correctly.
	 (green)	Flashing (1 Hz)	<b>Standby:</b> The device has not been configured.
	 (green/red/green)	Flashing fast green/red/green	<b>Self-test:</b> The device performs a self-test after power-on. The following sequence is displayed during the self-test: <ul style="list-style-type: none"> <li>• NS-LED off.</li> <li>• MS LED turns green for approximately 250 ms, turns red for approximately 250 ms, and again turns green (and holds that state until the power-up test has completed).</li> <li>• NS LED turns green for approximately 250 ms, turns red for approximately 250 ms, and then turns off (and holds that state until the power-up test has completed).</li> </ul>
	 (red)	Flashing (1 Hz)	<b>Major recoverable fault:</b> The device has detected a major recoverable fault. E.g., an incorrect or inconsistent configuration can be considered a major recoverable fault.
	 (red)	On	<b>Major unrecoverable fault:</b> The device has detected a major unrecoverable fault.
	 (off)	Off	<b>No power:</b> The device is powered off.
<b>NS</b> (Network status)	<b>Duo-LED red/green</b>		
	 (green)	On	<b>Connected:</b> An IP address is configured, at least one CIP connection (any transport class) is established, and an Exclusive Owner connection has not timed out.
	 (green)	Flashing (1 Hz)	<b>No connections:</b> An IP address is configured, but no CIP connections are established, and an Exclusive Owner connection has not timed out.
	 (green/red/off)	Flashing fast green/red/off	<b>Self-test:</b> The device performs a self-test after power-on. Refer to the description of the MS LED in the self-test status.
	 (red)	Flashing (1 Hz)	<b>Connection timeout:</b> An IP address is configured, and an Exclusive Owner connection for which this device is the target has timed out.  The NS LED returns to steady green only when all timed out Exclusive Owner connections are reestablished.
	 (red)	On	<b>Duplicate IP:</b> The device has detected that its IP address is already in use.
 (off)	(Off)	<b>Not powered, no IP address:</b> The device does not have an IP address (or is powered off).	
<b>LINK</b>	<b>LED green</b>		
	 (green)	On	The device is linked to the Ethernet.
	 (off)	Off	The device has no link to the Ethernet.
<b>ACT</b>	<b>LED yellow</b>		
	 (yellow)	Flickering (load dependent)	The device sends/receives Ethernet frames.
	 (off)	Off	The device does not send/receive Ethernet frames.

Table 59: LED states for the EtherNet/IP Adapter protocol

LED state	Definition
Flashing (1 Hz)	The LED turns on and off with a frequency of 1 Hz: "On" for 500 ms, followed by "Off" for 500 ms.
Flashing fast green/red/green	The MS LED or NS LED turns on green "On" for 250 ms, then red "On" for 250 ms, then green "On" (until the test is completed).
Flickering (load dependent)	The LED turns on and off with a frequency of approximately 10 Hz to indicate high Ethernet activity: "On" for approximately 50 ms, followed by "Off" for 50 ms. The LED turns on and off in irregular intervals to indicate low Ethernet activity

*Table 60: LED state definitions for the EtherNet/IP Adapter protocol*

To determine the position of the LEDs use the device drawings in section *LEDs and control elements* [▶ page 30].

### 9.3.5 LEDs Open Modbus/TCP

The following table describes the LEDs for Open Modbus/TCP.











LED	Color	State	Description
RUN	<b>Duo LED red/green</b>		
	 (green)	On	<b>Connected:</b> OMB task has communication. At least one TCP connection is established.
	 (green)	Flashing (1 Hz)	<b>Ready, not configured yet:</b> OMB task is ready and not yet configured.
	 (green)	Flashing (5 Hz)	<b>Waiting for Communication:</b> OMB task is configured.
	 (off)	Off	<b>Not Ready:</b> OMB task is not ready.
ERR	<b>Duo LED red/green</b>		
	 (off)	Off	No communication error
	 (red)	Flashing (2 Hz, 25% on)	System error
	 (red)	On	Communication error active
LINK	<b>LED green</b>		
	 (green)	On	The device is linked to the Ethernet.
	 (off)	Off	The device has no link to the Ethernet.
ACT	<b>LED yellow</b>		
	 (yellow)	Flickering (load dependent)	The device sends/receives Ethernet frames.
	 (off)	Off	The device does not send/receive Ethernet frames.

Table 61: LED states for the OpenModbusTCP protocol

LED state	Definition
Flashing (1 Hz)	The LED turns on and off with a frequency of 1 Hz: "On" for 500 ms, followed by "Off" for 500 ms.
Flashing (2 Hz, 25% on)	The LED turns on and off with a frequency of 2 Hz: "On" for 125 ms, followed by "Off" for 375 ms.
Blinking (5 Hz)	The LED turns on and off with a frequency of 5 Hz: "On" for 100 ms, followed by "Off" for 100 ms.
Flickering (load dependent)	The LED turns on and off with a frequency of approximately 10 Hz to indicate high Ethernet activity: "On" for approximately 50 ms, followed by "Off" for 50 ms. The LED turns on and off in irregular intervals to indicate low Ethernet activity.

Table 62: LED state definitions for the OpenModbusTCP protocol

To determine the position of the LEDs use the device drawings in section *LEDs and control elements* [▶ page 30].

### 9.3.6 LEDs POWERLINK Controlled Node

The following table describes the LEDs for POWERLINK Controlled Node.













LED	Color	State	Description
<b>BS</b> (Bus status)	<b>Duo LED red/green</b>		
	 (green)	On	Slave is in ' <b>Operational</b> ' state.
	 (green)	Triple flash	Slave is in ' <b>ReadyToOperate</b> ' state.
	 (green)	Double flash	Slave is in ' <b>Pre-Operational 2</b> ' state.
	 (green)	Single flash	Slave is in ' <b>Pre-Operational 1</b> ' state.
	 (green)	Flickering (10 Hz)	Slave is in ' <b>Basic Ethernet</b> ' state
	 (green)	Blinking (2.5 Hz)	Slave is in ' <b>Stopped</b> ' state.
<b>BE</b> (Bus Error)	 (off)	Off	Slave has no error
	 (red)	On	Slave has detected an error
	<b>Duo LED red/green</b>		
<b>L/A</b>	<b>LED green</b>		
	 (green)	On	<b>Link:</b> The device is linked to the Ethernet, but does not send/receive Ethernet frames.
	 (green)	Flickering (load dependent)	<b>Activity:</b> The device is linked to the Ethernet and sends/receives Ethernet frames.
	 (off)	Off	The device has no link to the Ethernet.
<b>LED yellow</b>			
 (off)	Off	This LED is not used.	

Table 63: LED states for the POWERLINK Controlled Node protocol

LED state	Definition
Triple flash	The LED shows a sequence of three short flashes (each 200 ms), separated by a short "Off" phase (200 ms). The sequence is finished by a long "Off" phase (1,000 ms).
Double flash	The LED shows a sequence of two short flashes (each 200 ms), separated by a short "Off" phase (200 ms). The sequence is finished by a long "Off" phase (1,000 ms).
Single flash	The LED shows one short flash (200 ms) followed by a long "Off" phase (1,000 ms).
Flickering (10 Hz)	The LED turns on and off with a frequency of 10 Hz: "On" for 50 ms, followed by "Off" for 50 ms. The red LED and the green LED are switched on alternately.
Blinking (2.5 Hz)	The LED turns on and off phase with a frequency of 2,5 Hz: "On" for 200 ms followed by "Off" for 200 ms. The red LED and the green LED are switched on alternately.
Flickering (load dependant)	The LED turns on and off with a frequency of approximately 10 Hz to indicate high Ethernet activity: "On" for approximately 50 ms, followed by "Off" for 50 ms. The LED turns on and off in irregular intervals to indicate low Ethernet activity.

Table 64: LED state definitions for the POWERLINK Controlled Node protocol

To determine the position of the LEDs use the device drawings in section *LEDs and control elements* [▶ page 30].

### 9.3.7 LEDs PROFINET IO-Controller

The following table describes the LEDs for PROFINET IO-Controller.







SYS	SF	BF	Description
System status	System Failure	Bus Failure	LED name name
Yellow/green	Red/green	Red/green	Colours of the Duo LEDs SYS, SF or BF
<b>Firmware and Configuration</b>			
● Off	● Off	● Off	Power supply for the device is missing or hardware defect.
● On, yellow	● Off	● Off	No second stage bootloader found in Flash memory.
 Flashing, green/ yellow, cyclic	● Off	● Off	No firmware file found in Flash file system.
● On, green	● On, red	● Off	PROFINET IO Controller is not configured.
● On, green	● Off	● On, red	No Ethernet port has a link. E. g., no cable connected to any of the Ethernet ports.
● On, green	● Off	 Flashing, red, 2 Hz	PROFINET IO Controller is not online (Bus is switched to Off).
<b>PROFINET communication</b>			
● On, green	● Off or ● On, red	 Flashing, red, 1Hz	Not all configured devices are in data exchange.
● On, green	● On, red	-	One IO Device connected to the PROFINET IO Controller reports a problem.
● On, green	● Off	● Off	All devices are in data exchange and no problem has been reported by any device.
<b>PROFINET IO Controller operation</b>			
● On, green	 Flashing, red, 1 Hz, 3 s	● Off	A PROFINET DCP Set Signal has been received.
● On, green	 Flashing, red, 2 Hz	 Flashing, red, 2 Hz	The PROFINET IO Controller has detected an address conflict. Another device in the network is using the same Name of Station or IP address as the PROFINET IO Controller.  Or watchdog error
● On, green	● On, red	● On, red	No valid Master license

Table 65: PROFINET IO Controller, SYS, COM0 and COM1 LEDs states

LED	Color	State	Description
LINK	<b>LED green</b>		
	● (green)	On	The device is linked to the Ethernet.
	● (off)	Off	The device has no link to the Ethernet.
RX/TX	<b>LED yellow</b>		
	 (yellow)	Flickering (load dependent)	The device sends/receives Ethernet frames.
	● (off)	Off	The device does not send/receive Ethernet frames.

Table 66: PROFINET IO Controller, Ethernet LEDs states

LED state	Definition
Flashing (1 Hz, 3 s)	The LED turns on and off for 3 seconds with a frequency of 1 Hz: "On" for 500 ms, followed by "Off" for 500 ms.
Flashing (1 Hz)	The LED turns on and off with a frequency of 1 Hz: "On" for 500 ms, followed by "Off" for 500 ms.
Flashing (2 Hz)	The LED turns on and off with a frequency of 2 Hz: "On" for 250 ms, followed by "Off" for 250 ms.
Flickering (load dependent)	The LED turns on and off with a frequency of approximately 10 Hz to indicate high Ethernet activity: "On" for approximately 50 ms, followed by "Off" for 50 ms. The LED turns on and off in irregular intervals to indicate low Ethernet activity.

Table 67: PROFINET IO Controller, LEDs states definitions

To determine the position of the LEDs use the device drawings in section *LEDs and control elements* [▶ page 30].

### 9.3.8 LEDs PROFINET IO-Device

The following table describes the LEDs for PROFINET IO-Device.

LED	Color	State	Description
<b>SF</b> (System Failure)	<b>Duo LED red/green</b>		
	● (off)	Off	No error
	☀ (red)	Flashing (1 Hz, 3 s)	DCP signal service is initiated via the bus.
	● (red)	On	Watchdog timeout; channel, generic or extended diagnosis present; system error
<b>BF</b> (Bus Failure)	<b>Duo LED red/green</b>		
	● (off)	Off	No error
	☀ (red)	Flashing (2 Hz)	No data exchange
	● (red)	On	No configuration; or low speed physical link; or no physical link
<b>LINK</b>	<b>LED green</b>		
	● (green)	On	The device is linked to the Ethernet.
	● (off)	Off	The device has no link to the Ethernet.
<b>RX/TX</b>	<b>LED yellow</b>		
	☀ (yellow)	Flickering (load dependent)	The device sends/receives Ethernet frames.
	● (off)	Off	The device does not send/receive Ethernet frames.

Table 68: LED states for the PROFINET IO-Device protocol

LED state	Definition
Flashing (1 Hz, 3 s)	The LED turns on and off for 3 seconds with a frequency of 1 Hz: "On" for 500 ms, followed by "Off" for 500 ms.
Flashing (2 Hz)	The LED turns on and off with a frequency of 2 Hz: "On" for 250 ms, followed by "Off" for 250 ms.
Flickering (load dependent)	The LED turns on and off with a frequency of approximately 10 Hz to indicate high Ethernet activity: "On" for approximately 50 ms, followed by "Off" for 50 ms. The LED turns on and off in irregular intervals to indicate low Ethernet activity.

Table 69: LED state definitions for the PROFINET IO-Device protocol

To determine the position of the LEDs use the device drawings in section *LEDs and control elements* [▶ page 30].



### 9.3.9 LEDs Sercos Master

The following table describes the LEDs for Sercos Master.





















LED	Color	State	Description
<b>STA</b>	<b>Duo LED red/green</b>		
	 (green)	On	<b>CP4: Communication phase 4</b>
	 (green)	Triple Flash	<b>CP3: Communication phase 3</b>
	 (green)	Double flash	<b>CP2: Communication phase 2</b>
	 (green)	Single flash	<b>CP1: Communication phase 1</b>
	 (green)	Blinking (2.5 Hz)	<b>CP0: Communication phase 0</b>
	 (green)	Flickering (10 Hz)	<b>Master is not configured and is in NRT.</b> After a status change this isn't indicated again
	 (off)	Off	<b>NRT: Non Real-Time Mode</b>
<b>ERR</b>	<b>Duo LED red/green</b>		
	 (red)	Single flash	Bus Sync error threshold
	 (red)	Double flash	Internal Stop of the bus cycle
	 (red)	Triple Flash	DPM watchdog has expired.
	 (red)	Quadruple Flash	No Master license present in the device.
	 (red)	Blinking (2.5 Hz)	Error in the configuration database.
	 (red)	Single Flickering	Channel Init was executed at the Master. Transient state that may not visible at all.
	 (red)	Double Flickering	Slave is missing. Unconfigured slave No matching mandatory slave list No bus connected Duplicate Sercos address Invalid Sercos address
	 (red)	Flickering (10 Hz)	Boot-up was stopped due to an error.
 (off)	Off	No error	
<b>L/A</b>	<b>LED green</b>		
	 (green)	On	<b>Link:</b> The device is linked to the Ethernet, but does not send/receive Ethernet frames.
	 (green)	Flickering (load dependent)	<b>Activity:</b> The device is linked to the Ethernet and sends/receives Ethernet frames.
 (off)	Off	The device has no link to the Ethernet.	
	<b>LED yellow</b>		
	 (off)	Off	This LED is not used.

Table 70: LED states for the Sercos Master protocol

LED state	Definition
Single flash	The LED shows one short flash (200 ms) followed by a long "Off" phase (1,000 ms).
Double flash	The LED shows a sequence of two short flashes (each 200 ms), separated by a short "Off" phase (200 ms). The sequence is finished by a long "Off" phase (1,000 ms).
Triple flash	The LED shows a sequence of three short flashes (each 200 ms), separated by a short "Off" phase (200 ms). The sequence is finished by a long "Off" phase (1,000 ms).
Quadruple flash	The LED shows a sequence of four short flashes (each 200 ms), separated by a short "Off" phase (200 ms). The sequence is finished by a long "Off" phase (1,000 ms).
Blinking (2.5 Hz)	The LED turns on and off with a frequency of 2.5 Hz: "On" for 200 ms, followed by "Off" for 200 ms.
Single Flickering	The LED is switched on and off once: "On" for 50 ms, followed by "Off" for 500 ms.
Double Flickering	The LED is switched on and off and on once: "On" / "Off" / "On" each for approximately 50 ms, followed by "Off" for 500 ms.
Flickering (10 Hz)	The LED turns on and off with a frequency of 10 Hz: "On" for 50 ms, followed by "Off" for 50 ms.
Flickering (load dependent)	The LED turns on and off with a frequency of approximately 10 Hz to indicate high Ethernet activity: "On" for approximately 50 ms, followed by "Off" for 50 ms. The LED turns on and off in irregular intervals to indicate low Ethernet activity.

*Table 71: LED state definitions for the Sercos Master protocol*

To determine the position of the LEDs use the device drawings in section *LEDs and control elements* [► page 30].

## 9.3.10 LEDs Sercos Slave

The following table describes the LEDs for Sercos Slave.

















LED	Color	State	Description
S	<b>Duo-LED red/green</b> (orange = red/green simultaneously)		
	 (green)	On	<b>CP4: Communication phase 4:</b> Normal operation, no error
	 (green)	Flashing (2 Hz)	<b>Loopback:</b> The network state has changed from „fast-forward“ to „loopback“.
	 (green/ orange)	Flashing (1 x green/3s)	<b>CP3: Communication phase 3</b>
		(2 x green/3s)	<b>CP2: Communication phase 2</b>
		(1 x green/3s)	<b>CP1: Communication phase 1</b>
	 (orange)	On	<b>CP2: Communication phase 0</b>
	 (orange/ green)	Flashing (2 Hz)	<b>HP0: Hot-plug mode</b>
		(1 x orange/3s)	<b>HP1: Hot-plug mode</b>
		(2 x orange/3s)	<b>HP2: Hot-plug mode</b>
	 (orange)	Flashing (2 Hz)	<b>Identification:</b> Invoked by (C-DEV.Bit15 in the Device Control) Or SIP Identification Request
	 (green/red)	Flashing (2 Hz, min. 2s)	<b>MST losses <math>\geq</math> (S-0-1003/2):</b> The communication warning (S-DEV.Bit 15) is present in the device status.
	 (red/orange)	Flashing (2 Hz)	<b>Application error (C1D):</b> See GDP & FSP Status codes class error.
 (red)	Flashing (2 Hz)	<b>Watchdog error:</b> Application is not running.	
 (red)	On	<b>Communication Error (C1D):</b> Error detected according to Sercos third generation Class 1 Diagnosis, see SCP Status codes class error.	
 (off)	Off	<b>NRT-Mode:</b> (Non Real-Time Mode) No Sercos Communication	
<b>Duo LED red/green</b>			
 (off)	Off	This LED is not used.	
L/A	<b>LED green</b>		
	 (green)	On	<b>Link:</b> The device is linked to the Ethernet, but does not send/ receive Ethernet frames.
	 (green)	Flickering (load dependent)	<b>Activity:</b> The device is linked to the Ethernet and sends/ receives Ethernet frames.
 (off)	Off	The device has no link to the Ethernet.	
<b>LED yellow</b>			
 (off)	Off	This LED is not used.	

Table 72: LED states for the Sercos Slave protocol

LED state	Definition
Flashing (2 Hz)	The LED turns on and off with a frequency of 2 Hz: <i>one color</i> : "On" for appr. 250 ms, followed by "Off" for appr. 250 ms. <i>two colors</i> : First color for appr. 250 ms, followed by the second color for appr. 250 ms.
Flashing (1 x green/3s)	Flashing green for 250 ms, then orange on for 2 second and 750 ms.
Flashing (2 x green/3s)	Flashing green / orange / green, each for 250 ms, then orange on for 2 seconds and 250 ms.
Flashing (3 x green/3s)	Flashing green / orange / green / orange / green, each for 250 ms, then orange on for 1 second and 750 ms.
Flashing (1 x orange /3s)	Flashing orange for 250 ms, then green on for 2 second an 750 ms.
Flashing (2 x orange /3s)	Flashing orange / green / orange, each for 250 ms, then green on for 2 seconds and 250 ms.
Flickering (load dependent)	The LED turns on and off with a frequency of approximately 10 Hz to indicate high Ethernet activity: "On" for approximately 50 ms, followed by "Off" for 50 ms. The LED turns on and off in irregular intervals to indicate low Ethernet activity.

Table 73: LED state definitions for the Sercos Slave protocol

To determine the position of the LEDs use the device drawings in section *LEDs and control elements* [▶ page 30].

## 9.4 LEDs Fieldbus systems

### 9.4.1 LED CANopen Master

The following table describes the LEDs for CANopen Master.







LED	Color	State	Description
CAN	Duo LED red/green		
	 (green)	On	<b>OPERATIONAL:</b> The device is in the OPERATIONAL state.
	 (green)	Blinking (2.5 Hz)	<b>PREOPERATIONAL:</b> The device is in the PREOPERATIONAL state.
	 (green)	Single flash	<b>STOPPED:</b> The device is in STOPPED state.
	 (red)	Single flash	<b>Warning limit reached:</b> At least one of the error counters of the CAN controller has reached or exceeded the warning level (too many error frames).
	 (red)	Double flash	<b>Error control event:</b> A guard event (NMT Slave or NMT Master) or a heartbeat event (Heartbeat consumer) has occurred.
	 (red)	On	<b>Bus off:</b> The CAN controller is in bus OFF state.
 (off)	Off	<b>RESET:</b> The device is executing a reset or the device has no configuration.	

Table 74: LED states for the CANopen Master protocol

LED states	Definition
Blinking (2.5 Hz)	The LED turns on and off with a frequency of 2.5 Hz: "On" for 200 ms, followed by "Off" for 200 ms.
Single flash	The LED shows one short flash (200 ms) followed by a long "Off" phase (1,000 ms).
Double flash	The LED shows a sequence of two short flashes (each 200 ms), separated by a short "Off" phase (200 ms). The sequence is finished by a long "Off" phase (1,000 ms).

Table 75: LED state definitions for the CANopen Master protocol

To determine the position of the LEDs use the device drawings in section *LEDs and control elements* [▶ page 30].

## 9.4.2 LED CANopen Slave

The following table describes the LED for CANopen Slave.









LED	Color	State	Description
CAN	Duo LED red/green		
	 (green)	On	<b>OPERATIONAL:</b> The device is in the OPERATIONAL state.
	 (green)	Blinking (2.5 Hz)	<b>PREOPERATIONAL:</b> The device is in the PREOPERATIONAL state.
	 (green)	Single flash	<b>STOPPED:</b> The device is in STOPPED state.
	 (red/green)	Flickering (10 Hz)	<b>Auto baud rate detection active:</b> The Device is in the auto baud rate detection mode.
	 (red)	Single flash	<b>Warning limit reached:</b> At least one of the error counters of the CAN controller has reached or exceeded the warning level (too many error frames).
	 (red)	Double flash	<b>Error control event:</b> A guard event (NMT Slave or NMT Master) or a heartbeat event (Heartbeat consumer) has occurred.
	 (red)	On	<b>Bus off:</b> The CAN controller is in bus OFF state.
 (off)	Off	<b>RESET:</b> The device is executing a reset or the device has no configuration.	

Table 76: States of the CAN LED for the CANopen Slave protocol

LED state	Definition
Flickering (10 Hz)	The LED turns on and off with a frequency of 10 Hz: "On" for 50 ms, followed by "Off" for 50 ms.
Blinking (2.5 Hz)	The LED turns on and off with a frequency of 2.5 Hz: "On" for 200 ms, followed by "Off" for 200 ms.
Single flash	The LED shows one short flash (200 ms) followed by a long "Off" phase (1,000 ms).
Double flash	The LED shows a sequence of two short flashes (each 200 ms), separated by a short "Off" phase (200 ms). The sequence is finished by a long "Off" phase (1,000 ms). The LED turns on and off in irregular intervals to indicate low Ethernet activity.

Table 77: LED state definitions for the CANopen Slave protocol

To determine the position of the LEDs use the device drawings in section *LEDs and control elements* [▶ page 30].

### 9.4.3 LED CC-Link Slave

The following table describes the LEDs for CC-Link Slave.





LED	Color	State	Description
L RUN	<b>LED green</b>		
	 (green)	On	After participating in the network, the device receives both refresh and polling signals or just the refresh signal normally.
	 (off)	Off	1. Before participating in the network 2. Unable to detect carrier 3. Timeout 4. Resetting hardware
L ERR	<b>LED red</b>		
	 (red)	Blinking	The switch setting has been changed from the setting at the reset cancellation (blinks for 0.4 sec.).
	 (red)	On	1. CRC error 2. Address parameter error (0.65 or greater is set including the number of occupied stations) 3. Baud rate switch setting error during cancellation of reset (5 or greater)
	 (off)	Off	1. Normal communication 2. Resetting hardware

Table 78: LED states for the CC-Link Slave protocol

To determine the position of the LEDs use the device drawings in section *LEDs and control elements* [▶ page 30].

## 9.4.4 LED DeviceNet Master

The following table describes the LED for DeviceNet Master.







LED	Color	State	Description
MNS	<b>Duo LED red/green</b>		
	 (green)	On	<b>Device operational AND on-line, connected</b> Device is online and has established all connections with all Slaves.
	 (green)	Flashing (1 Hz)	<b>Device operational AND on-line</b> Device is online and has established no connection in the established state. - Configuration missing, incomplete or incorrect.
	 (green/red/off)	Flashing green/red/off	<b>Self-test:</b> The device performs a self-test after power-on. The MNS LED turns green for approximately 250 ms, then turns red for approximately 250 ms, then turns off.
	 (red)	Flashing (1 Hz)	<b>Minor fault and/or connection time-out</b> Device is online and has established one or more connections in the established state. It has data exchange with at least one of the configured slaves.  Minor or recoverable fault: No data exchange with one of the configured Slaves. One or more Slaves are not connected.  Connection timeout.  No network power present.
	 (red)	On	<b>Critical fault or critical link failure</b> Critical connection failure; device has detected a network error: duplicateMAC-ID or severe error in CAN network (CAN-bus off).
	 (off)	Off	<b>Device is not powered</b> - The device may not be powered. <b>Device is not on-line and/or no network power</b> - The device has not yet completed the Dup_MAC_ID test. - The device is powered, but the network power is missing.

Table 79: LED states for the DeviceNet Master protocol

LED state	Definition
Flashing (1 Hz)	The LED turns on and off with a frequency of 1 Hz: "On" for 500 ms, followed by "Off" for 500 ms.
Flashing green/red/off	The LED turns on green "On" for 250 ms, then red "On" for 250 ms, then "Off".

Table 80: LED state definitions for the DeviceNet Master protocol

To determine the position of the LED use the device drawings in section *LEDs and control elements* [▶ page 30].



## 9.4.5 LED DeviceNet Slave

The following table describes the LED for DeviceNet Slave.









LED	Color	State	Description
MNS	<b>Duo LED red/green</b>		
	 (green)	On	<b>Device operational AND on-line, connected</b> Device is online and has established all connections with all Slaves.
	 (green)	Flashing (1 Hz)	<b>Device operational AND on-line</b> Device is online and has established no connection in the established state. - Configuration missing, incomplete or incorrect.
	   (green/red/off)	Flashing green/red/off	<b>Self-test:</b> The device performs a self-test after power-on. The MNS LED turns green for approximately 250 ms, then turns red for approximately 250 ms, then turns off.
	 (red)	Flashing (1 Hz)	<b>Minor fault and/or connection time-out</b> Device has no connection to the Master. Minor or recoverable fault: No data exchange with the Master. Connection timeout. No network power present.
	 (red)	On	<b>Critical fault or critical link failure</b> Critical connection failure; device has detected a network error: duplicate MAC-ID or severe error in CAN network (CAN-bus off).
 (off)	Off	<b>Device is not powered</b> - The device may not be powered. <b>Device is not on-line and/or no network power</b> - The device has not yet completed the Dup_MAC_ID test. - The device is powered, but the network power is missing.	

Table 81: LED states for the DeviceNet Slave protocol

LED state	Definition
Flashing (1 Hz)	The LED turns on and off with a frequency of 1 Hz: "On" for 500 ms, followed by "Off" for 500 ms.
Flashing green/red/off	The LED turns on green "On" for 250 ms, then red "On" for 250 ms, then "Off".

Table 82: LED state definitions for the DeviceNet Slave protocol

To determine the position of the LED use the device drawings in section *LEDs and control elements* [▶ page 30].

## 9.4.6 LED PROFIBUS DP Master

The following table describes the LED for PROFIBUS DP Master.







LED	Color	State	Description
COM	Duo LED red/green		
	 (green)	On	Communication to all Slaves is established.
	 (green)	Blinking (5 Hz)	PROFIBUS is configured, but the bus communication is not yet released from the application.
	 (green)	Flashing, acyclic	No configuration or faulty configuration
	 (red)	Blinking (5 Hz)	Communication to at least one Slave is disconnected.
	 (red)	On	Communication to all Slaves is disconnected or another serious error has occurred. Redundant Mode: The active Master was not found.
	 (off)	Off	Device is not switched on or supply voltage is missing.

Table 83: LED states for the PROFIBUS DP Master protocol

LEDs states	Definition
Blinking (5 Hz)	The LED turns on and off with a frequency of 5 Hz: "On" for 100 ms, followed by "Off" for 100 ms.
Flashing, acyclic	The LED turns on and off in irregular intervals.

Table 84: LED state definitions for the PROFIBUS DP Master protocol

To determine the position of the LED use the device drawings in section *LEDs and control elements* [▶ page 30].

## 9.4.7 LED PROFIBUS DP Slave

The following table describes the LED for PROFIBUS DP Slave.







LED	Color	State	Description
COM	<b>Duo LED red/green</b>		
	 (green)	On	RUN, cyclic communication
	 (green)	Flashing, cyclic (2 Hz)	Master is in CLEAR state.
	 (red)	Flashing, acyclic (1 Hz)	The device is not configured.
	 (red)	Flashing, cyclic (2 Hz)	STOP, no communication, connection error
	 (red)	On	Wrong configuration at PROFIBUS DP Slave.
	 (off)	Off	Device is not switched on or supply voltage is missing.

Table 85: LED states for the PROFIBUS DP Master protocol

LED states	Definition
Flashing, acyclic (1 Hz)	The LED turns on and off in irregular intervals, with a frequency of 1 Hz: "On" for 750 ms, followed by "Off" for 250 ms.
Flashing, cyclic (2 Hz)	The LED turns on and off with a frequency of 2 Hz: "On" for 250 ms, followed by "Off" for 250 ms.

Table 86: LED state definitions for the PROFIBUS DP Slave protocol

To determine the position of the LED use the device drawings in section *LEDs and control elements* [▶ page 30].

## 9.5 LEDs Serial

### 9.5.1 LED Modbus RTU

The following table describes the LED for Modbus RTU.





LED	Color	State	Description
COM	<b>Duo LED red/green</b>		
	● (green)	On	The device has a valid configuration for Modbus RTU and is ready for Modbus communication respectively sends/receives Modbus RTU telegrams.
	● (red)	On	<p><b>Communication error:</b></p> <p>The device works as <b>Modbus RTU Master:</b></p> <ul style="list-style-type: none"> <li>- The Slave device answered with an error (Modbus Exception), e. g. function code not supported, access to invalid register addresses or coil addresses.</li> <li>- Receive error detected, e. g. parity error or checksum error</li> <li>- timeout (Slave device does not answer).</li> </ul> <p>The device works as <b>Modbus RTU Slave:</b></p> <ul style="list-style-type: none"> <li>- The Modbus RTU Master device uses an invalid function code.</li> <li>- The Modbus RTU Master device has accessed to invalid register addresses or coil addresses.</li> <li>- Receive error detected, e. g. parity error or checksum error.</li> <li>- Timeout (application does not answer or answers with error).</li> </ul> <p>The error display is set back with the next error free Modbus telegram sequence.</p>
● (off)	Off	During initialization or invalid Modbus RTU configuration or missing power supply.	

*Table 87: LED states for the Modbus/RTU Master protocol*

To determine the position of the LED use the device drawings in section *LEDs and control elements* [▶ page 30].

## 9.5.2 LED ASCII

The following table describes the LED for ASCII.

LED	Color	State	Description
COM	<b>Duo LED red/green</b>		
	 (green)	Blinking (5 Hz)	The device sends/receives data.
	 (green)	On	The device is ready for serial communication.
	 (red)	Blinking (5 Hz)	The device is configured and is in stop state.
	 (red)	Blinking (1 Hz)	The device is not configured.
	 (off)	Off	During initialization or missing power supply.

*Table 88: LED states for the ASCII protocol*

LED state	Definition
Blinking (5 Hz)	The LED turns on and off with a frequency of 5 Hz: "On" for 100 ms, followed by "Off" for 100 ms.
Blinking (1 Hz)	The LED turns on and off with a frequency of 1 Hz: "On" for 500 ms, followed by "Off" for 500 ms.

*Table 89: LED state definitions for the ASCII protocol*

To determine the position of the LED use the device drawings in section *LEDs and control elements* [▶ page 30].

### 9.5.3 LED Serial with netSCRIPT

The following table describes the LED for netSCRIPT serial.

The meaning of the COM LED is determined by the device firmware, when the script is not executed. The meaning of the COM LED is determined by the script, when the script is executed.

#### Script is not executed

The device firmware does the following steps after the download of the netSCRIPT file into the device:

1. The script file is searched and loaded.
2. The script file was loaded successfully. The device firmware now switches the COM LED off.
3. The script file is executed. The script now has the control of the COM LED.





LED	Color	State	Description
COM	Duo LED red/green		
	 (red)	On	netSCRIPT file is searched and loaded.
	 (green)	On (for appr. 0.5 s)	netSCRIPT file was loaded successfully.
	 (red)	Single flash	No script file loaded Script error occurred, which lead to a stop of the script execution. The execution of the script was stopped with the debugger. If the red LED will change in this state, then the green LED keeps its last state, that e. g. is green or off.
	 (off)	Off	Script running The control of the LED states (after the startup sequence) is done with the netSCRIPT functions " <b>setRunLed()</b> " and " <b>setErrorLed()</b> " by the programmer

Table 90: LED states for 'Serial with netSCRIPT' – Script is not executed

LED state	Definition
Single flash	The LED shows one short flash (200 ms) followed by a long "off" phase (1,000 ms).

Table 91: LED state definitions for the netSCRIPT protocol

#### Script is executed





LED	Color	State	Meaning
COM	Duo LED red/green		
	 (red)	Controlled by the script	The meaning is defined by the use of the netSCRIPT function " <b>setRunLed()</b> " in the script.
	 (red)		
	 (green)	Controlled by the script	The meaning is defined by the use of the netSCRIPT function " <b>setErrorLed()</b> " in the script.
	 (green)		
	 (off)	Off	The meaning is defined by the use of the netSCRIPT function " <b>setRunLed()</b> " and " <b>setErroLed()</b> " in the script.

Table 92: LED states for 'Serial with netSCRIPT' – Script is executed

To determine the position of the LED use the device drawings in section *LEDs and control elements* [▶ page 30].

## 9.5.4 LED 3964R

The following table describes the LED for 3964R.







LED	Color	State	Description
COM	<b>Duo LED red/green</b>		
	 (green)	Flickering (10 Hz)	The device sends/receives data.
	 (green)	On	The device is ready for serial communication.
	 (red)	Blinking (5 Hz)	The device is configured and is in stop state.
	 (red)	Blinking (1 Hz)	The device is not configured.
	 (red)	On	Communication error: - Receive error detected, e. g. parity error or checksum error. - Timeout (remote device does not answer). The error display is set back with the next error free 3964R telegram sequence.  The error display is set back with the next error free 3964R telegram sequence.
	 (off)	Off	During initialization or missing power supply.

Table 93: LED states for the 3964R protocol

LED state	Definition
Flickering (10 Hz)	The LED turns on and off with a frequency of 10 Hz: "On" for 50 ms, followed by "Off" for 50 ms.
Blinking (5 Hz)	The LED turns on and off with a frequency of 5 Hz: "On" for 100 ms, followed by "Off" for 100 ms.
Blinking (1 Hz)	The LED turns on and off with a frequency of 1 Hz: "On" for 500 ms, followed by "Off" for 500 ms.

Table 94: LED state definitions for the 3964R protocol

To determine the position of the LED use the device drawings in section *LEDs and control elements* [► page 30].

# 10 Technical data

## 10.1 Technical data netTAP NT 100 Gateway

NT 100	Parameter	Value
Communication controller	Type	netX 100
Memory	RAM	8 MB SDRAM
	FLASH	4 MB serial Flash
	Memory card (optional)	Type: MMC or SD card Storage capacity: Max. 2 GByte <b>Important:</b> Comply with the requirements on using the memory card: Type, max. storage capacity, and format. The memory card must be formatted with FAT. The formats FAT12/16/32 are supported. The exFAT format is not supported.
	netSCRIPT and variable	approx. 1 MByte
Diagnostic interface	Socket	Mini-USB, 5-pin
Display	LED display	SYS System status APL Application status COM Communication status LINK link ACT Activity
Power supply	Voltage	24 V ± 6 V DC, with reverse voltage protection
	Current consumption at 24 V (typical)	130 mA
	Power consumption	3.2 W
	Connector	Mini-COMBICON, 2-pin
	Power supply	For UL-compliant use: The device must be powered from an isolated voltage source
Ambient conditions	Ambient temperature (operation)	0 °C ... + 60 °C
	Ambient temperature (storage)	40 °C ... +85 °C
	Relative humidity	10% ... 95% relative humidity, no condensation allowed
	Environment	For UL-compliant use: The use of the device is limited to an environment of pollution degree 2
Device	Dimensions (L x W x H)	100 mm x 52 mm x 70 mm (without connector)
	Weight	approx. 150 g
	Mounting	On DIN rail, DIN EN 60715
	Protection class	IP 20
	RoHS	Yes
CE mark	CE mark	Yes
	Emission	CISPR 11 Class A.
	Immunity	EN 61131-2:2003
UL	UL-listed: UL 508	UL file no. E334100
Configuration	Software	SYCON.net

Table 95: Technical data NT 100 (part 1)



NT 100	Parameter	Value	
Ethernet interface of the device types: NT 100-RE-CC NT 100-RE-CO NT 100-RE-DN NT 100-RE-DP NT 100-RE-RS	Transmission rate	100 MBit/s 10 MBit/s (depending on the firmware loaded)	
	Interface type	100 BASE-TX, isolated 10 BASE-TX (depending on the firmware loaded), isolated	
	Half duplex / full duplex	supported (at 100 MBit/s)	
	Auto-Negotiation	supported (depending on the firmware loaded)	
	Auto-Crossover	supported	
	Connector	2 * RJ45	
	PROFIBUS interface of the device types: NT 100-RE-DP NT 100-CO-DP NT 100-DN-DP NT 100-DP-DP NT 100-DP-CC NT 100-DP-CO NT 100-DP-DN NT 100-DP-RS	Transmission rate	9.6 kBit/s, 19.2 kBit/s, 31.25 kBit/s, 45.45 kBit/s, 93.75 kBit/s, 187.5 kBit/s, 500 kBit/s, 1.5 MBit/s, 3 MBit/s, 6 MBit/s, 12 MBit/s
Interface type		RS-485, potential-free	
Connector		D-Sub socket, 9-pin	
CANopen interface of the device types: NT 100-RE-CO NT 100-DN-CO NT 100-DP-CO NT 100-CO-CO NT 100-CO-CC NT 100-CO-DP NT 100-CO-DN NT 100-CO-RS	Transmission rate	10 kBit/s, 20 kBit/s, 50 kBit/s, 100 kBit/s, 125 kBit/s, 250 kBit/s, 500 kBit/s, 800 kBit/s, 1 MBit/s	
	Interface type	ISO 11898, potential-free	
	Connector	D-Sub connector, 9-pin	
DeviceNet interface of the device types: NT 100-RE-DN NT 100-DP-DN NT 100-CO-DN NT 100-DN-DN NT 100-DN-CO NT 100-DN-CC NT 100-DN-DP NT 100-DN-RS	Transmission rate	125 kBit/s, 250 kBit/s, 500 kBit/s	
	Interface type	ISO 11898, potential-free	
	Connector	COMBICON, 5-pin	

Table 96: Technical data NT 100 (part 2)

NT 100	Parameter	Value
CC-Link interface (version 1 and 2) of the device types: NT 100-RE-CC NT 100-DP-CC NT 100-CO-CC NT 100-DN-CC	Transmission rate	156 kBit/s, 625 kBit/s, 2500 kBit/s, 5 MBit/s, 10 MBit/s
	Interface type	RS-485, potential-free
	Connector	COMBICON, 5-pin
Serial interface of the device types: NT 100-RE-RS NT 100-CO-RS NT 100-DN-RS NT 100-DP-RS	Interface type	RS-232, RS-422, RS-485, potential-free
	Transfer rate with ASCII	300 Bit/s, 600 Bit/s, 1200 Bit/s, 2400 Bit/s, 4800 Bit/s, 9600 Bit/s, 19200 Bit/s, 38400 Bit/s, 57600 Bit/s, 115200 Bit/s
	Transmission rate with Modbus RTU	4800 Bit/s, 9600 Bit/s, 19200 Bit/s, 38400 Bit/s, 57600 Bit/s, 115200 Bit/s
	Transfer rate with netSCRIPT	Adjustable in range RS-232: 6 ... 460000 Bit/s RS-422: 6 ... 1000000 Bit/s RS-485: 6 ... 1000000 Bit/s

Table 97: Technical data NT 100 (part 3)

## 10.2 Technical data of Real-Time Ethernet protocols

### 10.2.1 EtherCAT Master

Parameter	Description
Maximum number of EtherCAT slaves	Maximum 200 slaves
Maximum number of cyclic input data	5760 bytes
Maximum number of cyclic output data	5760 bytes
Minimum bus cycle time	1 ms (fix)
Topology	Line
Baud rate	100 MBit/s
Data transport layer	Ethernet II, IEEE 802.3
Configuration file (ethercat.xml)	Maximum 1 MByte
Restrictions	<p>CoE upload, CoE download for user data transfer not supported</p> <p>The size of the bus configuration file is limited by the size of the RAM Disk (1 MByte)</p> <p>Only Ethernet Port 0 of the device is used for communication</p> <p>All CoE Uploads, Downloads and information services must fit in one TLR-Packet. Fragmentation is not supported</p> <p>Fragmentation is is not supported</p> <p>Support of Distributed clocks (Slave synchronisation) is always activated</p> <p>The bus cycle time is fixed to a value of 1000 <math>\mu</math>s</p> <p>The watchdog time is fixed to a value of 20 ms</p>
Reference to firmware/stack version	V2.0/V4.4

Table 98: Technical data EtherCAT Master

## 10.2.2 EtherCAT Slave

Parameter	Description
Maximum number of cyclic input data	200 bytes
Maximum number of cyclic output data	200 bytes
Type	Complex Slave
FMMUs	3 (netX 100/netX 500)
SYNC Manager	4 (netX 100/netX 500)
Baud rate	100 MBit/s
Data transport layer	Ethernet II, IEEE 802.3
Restrictions	Acyclic communication not supported LRW is not supported
Reference to firmware/stack version	V2.0/V4.7

Table 99: Technical data EtherCAT Slave

### 10.2.3 EtherNet/IP Scanner

Parameter	Description
Maximum number of connections	64 connections for implicit
Maximum number of total cyclic input data	5712 bytes
Maximum number of total cyclic output data	5760 bytes
Maximum number of cyclic input data	504 bytes per slave per telegram
Maximum number of cyclic output data	504 bytes per slave per telegram
IO Connection type	Cyclic, minimum 1 ms (depending on used number of connections and used number of input and output data)
UCMM, Class 3	Supported
Predefined standard objects	Identity Object, Message Router Object, Assembly Object, Connection Manager Object, Ethernet Link Object, TCP/IP Object
Topology	Tree, line, ring
DLR (Device Level Ring)	Beacon based 'Ring Node'
ACD (Address Conflict Detection)	Supported
DHCP	Supported
BOOTP	Supported
Baud rate	10 and 100 MBit/s
Data transport layer	Ethernet II, IEEE 802.3
Integrated switch	Supported
Restrictions	No acyclic user data communication CIP Sync Services are not implemented TAGs are not supported
Reference to firmware/stack version	V2.0/V2.10

Table 100: Technical data EtherNet/IP Scanner

## 10.2.4 EtherNet/IP Adapter

Parameter	Description
Maximum number of input data	504 bytes
Maximum number of output data	504 bytes
IO Connection (implicit)	1 exclusive owner, up to 2 listen only
IO Connection type	Cyclic, minimum 1 ms
UCMM	Supported
Predefined standard objects	Identity Object, Message Router Object, Assembly Object, Connection Manager Object, Ethernet Link Object, TCP/IP Object
Topology	Tree, line, ring
DLR (Device Level Ring)	Beacon based 'Ring Node'
ACD (Address Conflict Detection)	Supported
DHCP	Supported
BOOTP	Supported
Baud rate	10 and 100 MBit/s
Data transport layer	Ethernet II, IEEE 802.3
Integrated switch	Supported
Restrictions	No acyclic user data communication CIP Sync Services are not implemented TAGs are not supported
Reference to firmware/stack version	V2.0/V2.13

Table 101: Technical data EtherNet/IP Adapter

### 10.2.5 Open Modbus/TCP

Parameter	Description
Maximum number of input data	2880 registers
Maximum number of output data	2880 registers
Maximum number of connections	16
Acyclic communication	Read/write register: <ul style="list-style-type: none"> <li>• Max. 125 registers per read telegram (FC 3, 4, 23),</li> <li>• Max. 121 registers per write telegram (FC 23),</li> <li>• Max. 123 registers per write telegram (FC 16)</li> </ul> Read/write coil: <ul style="list-style-type: none"> <li>• Max. 2000 coils per read telegram (FC 1, 2),</li> <li>• Max. 1968 coils per write telegram (FC 15)</li> </ul>
Modbus function codes	1, 2, 3, 4, 5, 6, 7, 15, 16, 23 (funktion code 23 in server mode only)
Protocol mode	Client or server
Baud rate	10 and 100 MBit/s
Data transport layer	Ethernet II, IEEE 802.3
Reference to firmware/stack version	V2.0/V2.6

Table 102: Technical data Open Modbus/TCP

### 10.2.6 POWERLINK Controlled Node

Parameter	Description
Maximum number of cyclic input data	1490 bytes
Maximum number of cyclic output data	1490 bytes
Baud rate	100 MBit/s, half-duplex
Data transport layer	Ethernet II, IEEE 802.3
Ethernet POWERLINK version	V 2
Restriction	No acyclic user data communication No slave to slave communication
Reference to firmware/stack version	V2.0/V3.4

Table 103: POWERLINK Controlled Node

## 10.2.7 PROFINET IO-Controller

Parameter	Description
Maximum number PROFINET IO-Devices	128
Maximum number of total cyclic input data	5712 bytes
Maximum number of total cyclic output data	5760 bytes
Maximum number of cyclic input data	1024 bytes per device (= IOCR data length)
Maximum number of cyclic output data	1024 bytes per device (= IOCR data length)
Supported protocols	RTC – Real Time Cyclic Protocol, Class 1 RTA – Real Time Acyclic Protocol DCP – Discovery and configuration Protocol CL-RPC – Connectionless Remote Procedure Call
Context-Management by CL-RPC	Supported
Minimum cycle time	1 ms Different IO-Devices can be configured with different cycle times
Baud rate	100 MBit/s Full-duplex
Data transport layer	Ethernet II, IEEE 802.3
Configuration file	Maximum 1 MByte



Parameter	Description
Restrictions	<p>Read/Write Record not supported</p> <p>No alarm processing</p> <p>RT over UDP not supported</p> <p>Multicast communication not supported</p> <p>DHCP is not supported</p> <p>Only one IOCR per IO Device</p> <p>NameOfStation of IO-Controller cannot be set using the DCP SET NameOfStation service but only at start-up while configuring the IO-Controller</p> <p>SNMP is not supported</p> <p>LLDP is not supported</p> <p>The buffer for IO-Device diagnosis data will be overwritten in case of multiple diagnostic events. Only one (the last) event is stored at the same time. If a single event produces more than 200 bytes of diagnosis data, only the first 200 bytes will be taken care of.</p> <p>The usable (minimum) cycle time depends on the number of used IO-Devices, the number of used input and output data. The cycle-time, the number of configured IO Devices and the amount of IO data depend on each other. For example it is not possible due to performance reasons to have 128 IO-Devices communication with cycle-time 1ms.</p> <p>The size of the bus configuration file is limited by the size of the RAM Disk (1 MByte)</p> <p>Only one API (API = 0) is supported.</p> <p>The IO-Device feature "FastStartUp" can not be used.</p> <p>WriteMultiple-Record service is not supported.</p>
Reference to firmware/stack version	V2.0/V3.3

Table 104: Technical data PROFINET IO-Controller

### 10.2.8 PROFINET IO-Device

Parameter	Description
Maximum number of cyclic input data	1024 bytes
Maximum number of cyclic output data	1024 bytes
Supported protocols	RTC – Real Time Cyclic Protocol, Class 1 and 2 (unsynchronized) RTA – Real Time Acyclic Protocol DCP – Discovery and configuration Protocol CL-RPC – Connectionless Remote Procedure Call LLDP – Link Layer Discovery Protocol SNMP – Simple Network Management Protocol
Used rotocols (subset)	UDP, IP, ARP, ICMP (Ping)
Topology recognition	LLDP, SNMP V1, MIB2, physical device
Media redundancy	MRP Client
VLAN- und priority-tagging	Yes
Context-Management by CL-RPC	Supported
Minimum cycle time	1 ms for RTC1 and RTC2
Baud rate	100 MBit/s
Data transport layer	Ethernet II, IEEE 802.3
Restrictions	No acyclic user data communication RT over UDP not supported Multicast communication not supported DHCP is not supported RT Class 2 synchronized (IRT “flex”) is not supported RT Class 3 synchronized not supported FastStartUp is not supported. Access to the submodule granular status bytes (IOCS) is not supported. The amount of configured IO-data influences the minimum cycle time that can be reached Supervisor-AR is not supported, Supervisor-DA-AR is supported Only 1 Input CR and 1 Output CR are supported Multiple WriteRequests are not supported
Reference to firmware/stack version	V2.0/V4.4

Table 105: Technical data PROFINET IO-Device

### 10.2.9 Sercos Master

Parameter	Description
Maximum number of cyclic input data	5760 bytes (including Connection Control per Connection)
Maximum number of cyclic output data	5760 bytes (including Connection Control per Connection)
Maximum number of configured slave devices	511
Minimum cycle time	250 µs
Acyclic communication	Service channel: Read/Write/Commands (for configuration only)
Functions	Bus scan
Communication phases	NRT, CP0, CP1, CP2, CP3, CP4
Topology	Line and double ring
Redundancy	Supported
Baud rate	100 MBit/s, full-duplex
Data transport layer	Ethernet II, IEEE 802.3
Auto crossover	Supported
Supported Sercos version	Communication Specification Version 1.1.1/1.1.2
Restrictions	No acyclic user data communication NRT channel not supported Hot-Plug not supported Cross Communication not supported Ring healing (needed for redundancy) is only available if the Master has a configuration
Reference to firmware/stack version	V2.0/V2.1

Table 106: Technical data Sercos Master

## 10.2.10 Sercos Slave

Parameter	Description
Maximum number of cyclic input data (Tx)	128 bytes (including Connection Control and IO Status)
Maximum number of cyclic output data (Rx)	128 bytes (including Connection Control and IO Control)
Maximum number of slave devices	1
Sercos addresses	1 ... 511
Minimum cycle time	250 µs
Topology	Line and ring
Communication phases	NRT, CP0, CP1, CP2, CP3, CP4
Baud rate	100 MBit/s
Data transport layer	Ethernet II, IEEE 802.3
Supported Sercos version	Sercos in the third generation Communication Specification Version 1.1.2
Supported sercos Communication Profiles	SCP_FixCFG Version 1.1.1 SCP_VarCFG Version 1.1.1 SCP_VarCFG Version 1.1.3
Supported FSP profiles	FSP_IO
SCP_NRTPC support	Yes
S/IP support	Yes
Identification LED feature supported	Yes
Restrictions	Max. 2 connections: 1 for consumer and 1 for producer No acyclic user data communication Modifications of the Service-Channel Object Dictionary will be volatile after reset, if it resides on device Hot-Plug not supported Cross Communication not supported NRT Channel only forwarding and S/IP
Reference to firmware/stack version	V2.0/V3.5

Table 107: Technical data Sercos Slave

## 10.3 Technical data of field bus protocols

### 10.3.1 CANopen Master

Parameter	Description
Maximum number of CANopen nodes	126
Maximum number of cyclic input data	3584 bytes
Maximum number of cyclic output data	3584 bytes
Maximum number of receive PDOs	512
Maximum number of transmit PDOs	512
Exchange of process data	Via PDO transfer <ul style="list-style-type: none"> <li>• synchronized,</li> <li>• remotely requested, and</li> <li>• event driven (change of date)</li> </ul>
Functions	Emergency Message (Consumer) Node Guarding / Life Guarding, Heartbeat PDO Mapping NMT Master SYNC protocol (Producer) Simple boot-up process, reading object 1000H for identification
Baud rate	10 kBits/s, 20 kBits/s, 50 kBits/s, 100 kBits/s, 125 kBits/s, 250 kBits/s, 500 kBits/s, 800 kBits/s, 1 MBits/s
Data transport layer	CAN frames
CAN frame type for CANopen	11 bit
Restrictions	CoE upload, CoE download for user data transfer not supported
Reference to firmware/stack version	V2.0/V2.14

Table 108: Technical data CANopen Master

### 10.3.2 CANopen Slave

Parameter	Description
Maximum number of cyclic input data	512 bytes Objects 2200, 2201, 2202, 2203 each with up to 128 bytes
Maximum number of cyclic output data	512 bytes Objects 2000, 2001, 2002, 2003 each with up to 128 bytes
Maximum number of receive PDOs	64
Maximum number of transmit PDOs	64
Exchange of process data	Via PDO transfer <ul style="list-style-type: none"> <li>• synchronized,</li> <li>• remotely requested, and</li> <li>• event driven (change of date, event timer)</li> </ul>
Functions	Node Guarding / Life Guarding, Heartbeat PDO Mapping NMT Slave SYNC protocol (Consumer) SDO upload/download (server, for configuration) Emergency Message (Producer)
Baud rate	10 kBits/s, 20 kBits/s, 50 kBits/s, 100 kBits/s, 125 kBits/s, 250 kBits/s, 500 kBits/s, 800 kBits/s, 1 MBits/s Automatic baud rate detection is supported.
Data transport layer	CAN frames
CAN frame type for CANopen	11 bit
Restrictions	Timestamp (Producer/Consumer) not supported on application level.
Reference to firmware/stack version	V2.0/V3.7

Table 109: Technical data CANopen Slave

#### Configuration of the node address

The CANopen node address can be configured by SYCON.net or by address switches. The address switches can be activated with SYCON.net version 1.351 (or higher) and can be used with firmware version 1.5 (or higher).

### 10.3.3 CC-Link Slave

Parameter	Description
Firmware works according to CC-Link Version 2.0	
Station types	Remote Device Station (up to 4 occupied stations)
Maximum number of cyclic input data	368 bytes
Maximum number of cyclic output data	368 bytes
Input data remote device station	112 bytes (RY) and 256 ytes (RWw)
Output data remote device station	112 bytes (RX) and 256 Bytes (RWr)
Extension cycles	1, 2, 4, 8
Baud rates	156 kBit/s, 625 kBit/s, 2500 kBit/s, 5 MBit/s, 10 MBit/s
Restriction	Intelligent Device Station not supported
Firmware works according to CC-Link Version 1.11	
Station types	Remote I/O station, Remote device station' (up to 4 occupied stations)
Maximum number of cyclic input data	48 bytes
Maximum number of cyclic output data	48 bytes
Input data remote I/O station	4 bytes (RY)
Output data remote I/O station	4 bytes (RX)
Input data remote device station	4 bytes (RY) and 8 bytes (RWw) per occupied station
Output data remote device station	4 bytes (RX) and 8 bytes (RWr) per occupied station
Baud rates	156 kBit/s, 625 kBit/s, 2500 kBit/s, 5 MBit/s, 10 MBit/s
Firmware	
Reference to firmware/stack version	V2.0/V2.12

Table 110: Technical data CC-Link Slave

#### Configuration of the station number

The CC-Link station number can be configured by SYCON.net or by address switches. The address switches can be activated with SYCON.net version 1.351 (or higher) and can be used with firmware version 1.5 (or higher).

### 10.3.4 DeviceNet Master

Parameter	Description
Maximum number of DeviceNet slaves	63
Maximum number of total cyclic input data	3584 bytes
Maximum number of total cyclic output data	3584 bytes
Maximum number of cyclic input data	255 bytes/connection
Maximum number of cyclic output data	255 bytes/connection
Maximum configuration data	1000 bytes/slave
Connections	Bit Strobe Change of State Cyclic Poll Explicit Peer-to-Peer Messaging
Functions	Quick Connect
Fragmentation	Explicit and I/O
UCMM	Supported
Objects	Identity Object (Class Code 0x01) Message Router Object (Class Code 0x02) DeviceNet Object (Class Code 0x03) Connection Object (Class Code 0x05) Acknowledge Handler Object (Class Code 0x06)
Baud rate	125 kBits/s, 250 kBit/s, 500 kBit/s Automatic baud rate detection is not supported.
Data transport layer	CAN frames
Restrictions	User data transfer through the gateway only via IO connections
Reference to firmware/stack version	V2.0/V2.4

Table 111: Technical data DeviceNet Master



### 10.3.5 DeviceNet Slave

Parameter	Description
Maximum number of cyclic input data	255 bytes
Maximum number of cyclic output data	255 bytes
Connections	Poll Change of State Cyclic Bit Strobe
Fragmentation	Explicit and I/O
UCMM	Not supported
Baud rate	125 kBits/s, 250 kBit/s, 500 kBit/s Automatic baud rate detection is not supported.
Data transport layer	CAN frames
Restrictions	Access to Application Object only via IO connection
Reference to firmware/stack version	V2.0/V2.5

Table 112: Technical data DeviceNet Slave

#### Configuration of the MAC ID

The DeviceNet MAC ID can be configured by SYCON.net or by address switches. The address switches can be activated with SYCON.net version 1.351 (or higher) and can be used with firmware version 1.5 (or higher).

### 10.3.6 PROFIBUS DP Master

Parameter	Description
Maximum number of PROFIBUS DP Slaves	125
Maximum number of total cyclic input data	5712 bytes
Maximum number of total cyclic output data	5760 bytes
Maximum number of cyclic input data	244 bytes/slave
Maximum number of cyclic output data	244 bytes/slave
Configuration data	Max. 244 bytes per slave
Parameterization data per slave	7 bytes/slave standard parameters Max. 237 bytes/slave application specific parameters
Baud rate	9,6 kBits/s, 19,2 kBits/s, 31,25 kBits/s, 45,45 kBits/s, 93,75 kBits/s, 187,5 kBits/s, 500 kBits/s, 1,5 MBits/s, 3 MBits/s, 6 MBits/s, 12 MBit/s Automatic baud rate detection is not supported.
Data transport layer	PROFIBUS FDL
Restrictions	DP V1 services class 1 and 2 are not supported DP V2 services are not supported
Reference to firmware/stack version	V2.0/V2.9

Table 113: Technical data PROFIBUS DP Master

### 10.3.7 PROFIBUS DP Slave

Parameter	Description
Maximum number of cyclic input data	244 bytes
Maximum number of cyclic output data	244 bytes
Maximum number of modules	Max. 4 input modules and max. 4 output modules, max. 24 modules when using manual setting
Baud rate	9,6 kBits/s, 19,2 kBits/s, 31,25 kBits/s, 45,45 kBits/s, 93,75 kBits/s, 187,5 kBits/s, 500 kBits/s, 1,5 MBits/s, 3 MBits/s, 6 MBits/s, 12 MBit/s Automatic baud rate detection is supported.
Data transport layer	PROFIBUS FDL
Restrictions	DP V1 services class 1 and 2 to transfer user data are not supported SSCY1S – Slave to slave communication state machine not implemented Data exchange broadcast not implemented I&M0 with fixed settings only
Reference to firmware/stack version	V2.0/V2.10

Table 114: Technical data PROFIBUS DP Slave

#### Configuration of the station address

The PROFIBUS station address can be configured by SYCON.net or by address switches. The address switches can be activated with SYCON.net version 1.351 (or higher) and can be used with firmware version 1.5 (or higher).

## 10.4 Technical data of serial protocols

### 10.4.1 ASCII

Parameter	Description and value range
Maximum telegram length	1024 bytes
Data bits	7, 8 bits
Stop bits	1, 2 bit(s)
Parity	None, even, odd
Baud rate	300 Bit/s, 600 Bit/s, 1200 Bit/s, 2400 Bit/s, 4800 Bit/s, 9600 Bit/s, 19200 Bit/s, 38400 Bit/s, 57600 Bit/s, 115200 Bit/s
Duplex	Half-duplex
Flow control	None
Indicator for end of received telegram	On receipt of a fixed number of characters On receipt of termination character(s) Elapse of character delay time
Timing parameter	Acknowledge timeout Receive watchdog time Send cycle time Character delay time
Number of send buffers	1
Number of receive buffers	1
Number of transmission retries	1
Maximum number of structure elements of a send telegram	10
Maximum number of structure elements of a receive telegram	10
Structure elements	Start character(s) Device address Object index or start address Command identifier Data area with length information Data area with termination character(s) End character(s) Checksum Character(s) without meaning (fix length)
Checksum methods	CRC8, CRC16, CRC32, Exor
Reference to firmware/stack version	V2.0/V1.1

Table 115: Technical data ASCII

### 10.4.2 Modbus RTU Master/Slave

Parameter	Description, value range
Maximum number of input data	2880 registers
Maximum number of output data	2880 registers
Acyclic communication	Read/write register <ul style="list-style-type: none"> <li>• Maximum 125 registers per read telegram (FC 3, 4)</li> <li>• Maximum 123 registers per write telegram (FC 16)</li> <li>• Maximum 118 registers per write telegram (FC 23)</li> <li>• Maximum 118 registers per read telegram (FC 23)</li> </ul> Read/write coil <ul style="list-style-type: none"> <li>• Maximum 2000 coils per read telegram (FC 1, 2),</li> <li>• Maximum 1968 coils per write telegram (FC 15)</li> </ul>
Function codes Modbus Master	1, 2, 3, 4, 5, 6, 15, 16
Function codes Modbus Slave	1, 2, 3, 4, 5, 6, 7, 8, 15, 16, 23
Mode	Modbus Master or Modbus Slave
Modbus address	1 ... 247
Baud rate	1200 Bit/s, 2400 Bit/s, 4800 Bit/s, 9600 Bit/s, 19200 Bit/s, 38400 Bit/s, 57600 Bit/s, 115200 Bit/s
Data bits	8 bits
Stop bits	1, 2 bit(s)
Parity	None, even, odd
Restrictions	Broadcast not supported
Reference to firmware/stack version	V2.0/V1.5

Table 116: Technical data Modbus RTU Master/Slave

### 10.4.3 netSCRIPT (Serial)

Parameter	Description and value range
Data bits	1 ... 8 bits
Inversion of data bits	Adjustable
Stop bits	1 ... 65535 bit(s), polarity is adjustable
Start bit	1 (polarity is adjustable)
Parity	none, even, odd, constant value
Baud rate	Depends on the used hardware interface. See technical data of the device.
Flow control RS-232	None or RTS/CTS handshake, Polarity of RTS signal adjustable
Timing parameter	Response timeout, programmable in script, Character delay time (adjustable) (resolution 10 ns)  Receive watchdog time and Send cycle time, programmable in script (resolution script cycle time)
Number of transmission retries	1 (retries programmable in script)
Maximum number of structure elements of a send telegram	Programmable in script
Maximum number of structure elements of a receive telegram	Programmable in script
Structure elements	Start character(s) Device address Object index or start address Command identifier Data area with length information Data area with termination character(s) End character(s) Checksum Character(s) without meaning All listed and further structure elements are programmable in script
Checksum methods	CRC algorithm configurable (width, polynom, initial value, bit direction of input bytes and result value)  XOR and sum function possible
Parameter FIFO Mode	
Maximum telegram length	Only limited by the script processing speed and by the data transfer speed
Duplex	Full-duplex for RS-232, RS-422 Half-duplex for RS-485
Indicator for end of received telegram	Programmable in script
Number of send buffers	1 (with 256 characters)
Number of receive buffers	1 (with 256 characters)
Parameter Block Mode	
Maximum telegram length	1024 bytes
Duplex	Half-duplex
Indicator for end of received telegram	Free definable end indicator with up to 64 bit and bit by bit AND mask

Parameter	Description and value range
Number of send/receive buffers	15 ... 240 (15 buffers with 1024 character buffer size, 240 buffers with 1 character buffer size)
Trailer bytes	0 ... 255 bytes
Firmware	
Reference to firmware/stack version	V2.0/V1.4

Table 117: Technical data of serial protocols

#### 10.4.4 3964R

Parameter	Description and value range
Maximum telegram length	5736 bytes
Data bits	7, 8 bits
Stop bits	1, 2 bit(s)
Parity	None, even, odd
Baud rate	300 Bit/s, 600 Bit/s, 1200 Bit/s, 2400 Bit/s, 4800 Bit/s, 9600 Bit/s, 19200 Bit/s, 38400 Bit/s, 57600 Bit/s, 115200 Bit/s
Duplex	Half-duplex
Priority	Adjustable: High or low Priority
Timing parameter	Acknowledge timeout Character delay time
Number of send buffers	1
Number of receive buffers	Ring Buffer with 30 buffers (FIFO)
Number of transmission retries	Adjustable
Checksum method	BCC
Reference to firmware/stack version	V2.0/V1.0

Table 118: Technical data 3964

## 11 Wiring instructions

Observe the wiring instructions for the corresponding networks to guarantee a correct function of the device. Always use shielded cables whose shield has a large-scale connection to the potential equalization at both ends. Lay the communication lines as far away as possible from the power lines to avoid EMC influence caused by switching operations in the power lines.

### 11.1 Assembly of D-Sub connectors

The design of the bus cabling is essential for the proper function of communication. Special attention should therefore be paid to the cable connections with its connectors and a good shield connection.

Connect the shield as follows:

- Dismantle the cable.
  - Pull back the shielding from the cable sheathing.
  - Reduce the shielding so that later it is covered by the nozzle.
  - Push a nozzle or shrinking tube over the cable sheathing so that a zone of 5 to 8 mm remains free at the cable end.
  - Connect the wire ends with the connector.
  - Push the cable in the plug to the bare braided shield under the strain relief.
  - Tighten the screws of the strain relief.
- ⇒ The figure shows how the cable connection should look like:

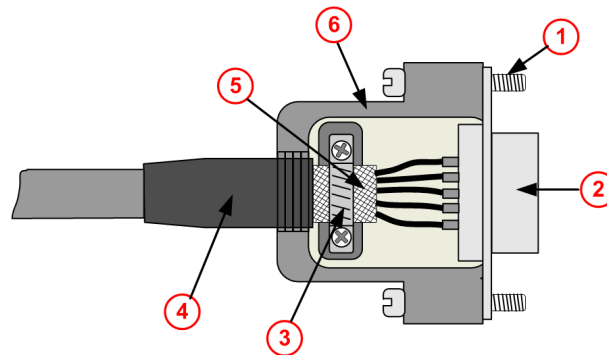

Figure 25: D-Sub cable assemblies

Pos.	Description
(1)	Fixing screw UNC
(2)	Metallic plug collar
(3)	Strain relief for connecting the shielding with the connector housing.
(4)	Shrinking tube or nozzle to cover the shielding and as bend protection.
(5)	Cable shielding pulled back over the cable sheathing.
(6)	Metallic or metallized connector housing

Table 119: D-Sub cable assemblies



## 11.2 Ethernet

### Use of hubs and switches

For the corresponding communication systems, the use of hubs and/or switches is either forbidden or allowed. The following table shows the acceptable use of hubs and switches by each communication system:

Communication system	Hub	Switch
EtherCAT	Forbidden	Allowed between EtherCAT Master and first EtherCAT Slave only (100 MBit/s, full-duplex)
EtherNet/IP	Allowed	Allowed (10 MBit/s, 100 MBit/s, full- or half-duplex, Auto-Negotiation)
Open Modbus/TCP	Allowed	Allowed (10 MBit/s, 100 MBit/s, full- or half-duplex, Auto-Negotiation)
POWERLINK	Allowed	Forbidden
PROFINET IO	Forbidden	Allowed only, if the switch supports 'Priority Tagging' and LLDP (100 MBit/s, full-duplex)
Sercos	Forbidden	Forbidden

Table 120: Use of hubs and switches

When using old NT 100-RE-XX devices, then follow::



#### Important:

Failure of the network communication

- Do not operate devices with the communication controllers netX 50, netX100 or netX 500 with the protocols Ethernet TCP/UDP/IP, EtherNet/IP or Modbus/TCP at 10 MBit/s in half-duplex mode, otherwise failure of the network communication can occur.
- Use only switches or 10/100 MBit/s dual-speed hubs and ensure that the network operates at 100 MBit/s and in full-duplex mode.

For further information refer to section *Failure in 10 MBit/s half-duplex mode and workaround* [▶ page 58].

## 11.3 PROFIBUS

Make sure that there are termination resistors at both ends of the cable. If special PROFIBUS connectors are used, these resistors are often inside the connector and only need to be switched on.

For baud rates above 1.5 MBit/s, use only PROFIBUS connectors that also include additional inductance.

At these high baud rates, branch lines are not allowed. Use only a special cable that is approved for PROFIBUS. With every device provide a large-scale connection from cable shield to ground and make sure that there is no potential difference between these points.

If you link the netTAP device with only one other device, both devices must be connected at the ends of the cable so that the termination resistors are supplied with voltage. Otherwise the Master can be connected at any other point.

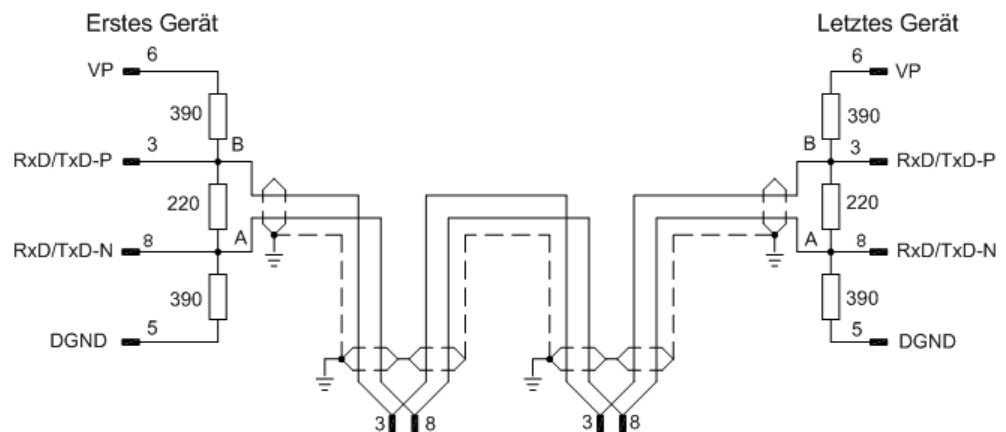

Figure 26: PROFIBUS cable and termination

You can link up to 32 DeviceNet devices in one bus segment. If several bus segments with repeaters are linked, max. 127 devices can be connected to the network.

The max. length of a bus segment depends on the baud rate used. Use only a special cable that is approved for PROFIBUS; preferably type A.

The max. cabl length depends on the baud rate und is indicated in the following table.

Baud rate	Max. cable length
9.6 kbit/s	1200 m
19.2 kbit/s	1200 m
93.75 kbit/s	1200 m
187.5 kbit/s	1000 m
500 kbit/s	400 m
1.5 Mbit/s	200 m
3 Mbit/s	100 m
6 Mbit/s	100 m
12 Mbit/s	100 m

Table 121: Max. cable length and baud rate for PROFIBUS

The following table contains the most important electrical data for a PROFIBUS cable:

Parameter	Value
Impedance	$150 \Omega \pm 15 \Omega$
Capacity	$< 30 \text{ pF/m}$
Loop resistance	$< 110 \Omega/\text{km}$
Wire diameter	0.64 mm

Table 122: Electrical requirements: PROFIBUS cable

## 11.4 CANopen

Use only a special cable that is approved for CAN with the following characteristics:

Parameter	Value
Impedance	$120 \Omega \pm 12 \Omega$
Capacity	$< 50 \text{ pF/m}$

Table 123: Electrical requirements: CANopen cable

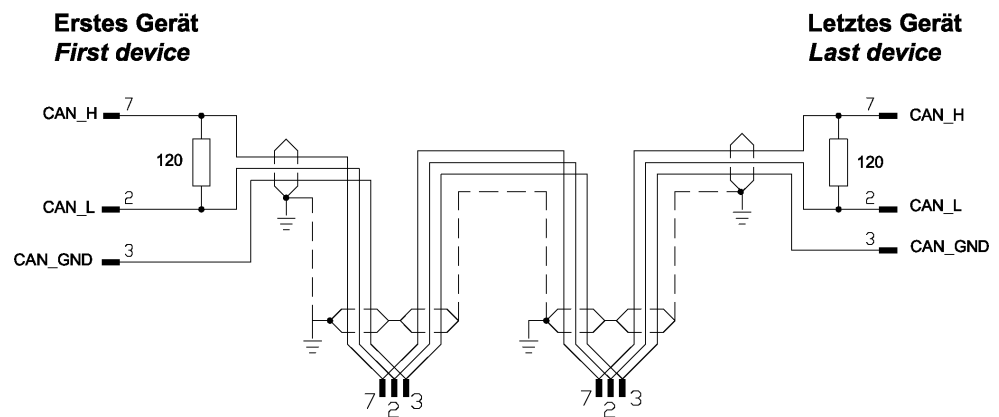

Figure 27: CANopen cable and termination

Termination resistors of  $120 \Omega$  must be installed at the ends of the network. Repeaters may be used to increase the number of connected nodes or the max. cable length.

The following table indicates the max. length for CANopen cables depending on baud rate, loop resistance, and the required wire cross section:

Baud rate	Max. length	Loop resistance	Wire cross section
10 kBit/s	1000 m	$< 26 \Omega/\text{km}$	0.75 ... 0.80 mm <sup>2</sup>
20 kBit/s	1000 m	$< 26 \Omega/\text{km}$	0.75 ... 0.80 mm <sup>2</sup>
50 kBit/s	1000 m	$< 26 \Omega/\text{km}$	0.75 ... 0.80 mm <sup>2</sup>
125 kBit/s	500 m	$< 40 \Omega/\text{km}$	0.50 ... 0.60 mm <sup>2</sup>
250 kBit/s	250 m	$< 40 \Omega/\text{km}$	0.50 ... 0.60 mm <sup>2</sup>
500 kBit/s	100 m	$< 60 \Omega/\text{km}$	0.34 ... 0.60 mm <sup>2</sup>
800 kBit/s	50 m	$< 60 \Omega/\text{km}$	0.34 ... 0.60 mm <sup>2</sup>
1 MBit/s	30 m	$< 70 \Omega/\text{km}$	0.25 ... 0.34 mm <sup>2</sup>

Table 124: Max. cable length and baud rate for CANopen

## 11.5 DeviceNet

You can link up to 64 DeviceNet devices together via the bus. The max. length of the cable depends on the baud rate and cable type. Use only a special cable that is approved for DeviceNet. The following table indicates the respective values.

Baud rate	Max. length of cable (thick cable)	Max. length of cable (thin cable)
125 kbit/s	500 m	100 m
250 kbit/s	250 m	100 m
500 kbit/s	100 m	100 m

Table 125: Max. cable length and baud rate for DeviceNet

The data transmission lines must meet the following requirements:

Parameter	Value (thick cable)	Value (thin cable)
Impedance	120 Ω	120 Ω
Capacity	< 39.4 pF/m	< 39.4 pF/m
Loop resistance	< 22.6 Ω/km	< 91.8 Ω/km
Wire diameter	2*1.1 mm	2*0.6 mm

Table 126: Electrical requirements on DeviceNet data lines

The power supply cables must meet the following requirements:

Parameter	Value (thick cable)	Value (thin cable)
Loop resistance	< 11.8 Ω/km	< 57.4 Ω/km
Wire diameter	2*1.4 mm	2*0.7 mm

Table 127: Electrical requirements on DeviceNet power supply cables

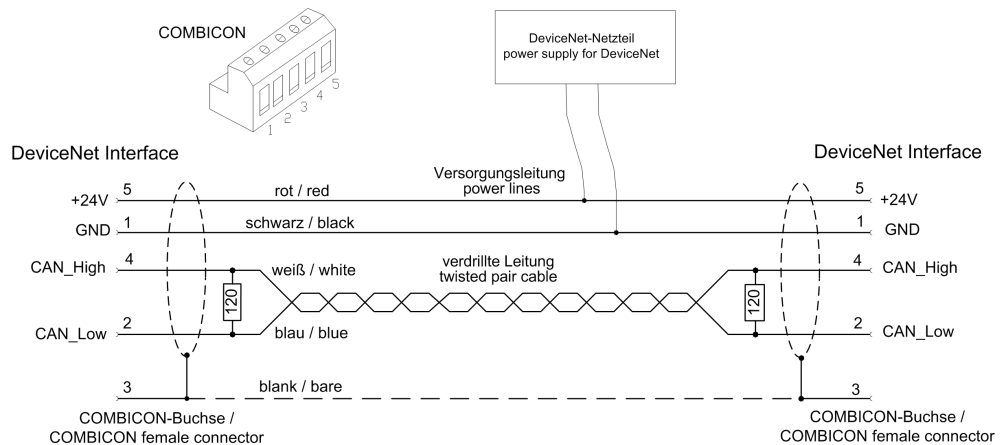

Figure 28: DeviceNet cable and termination

Make sure that there are termination resistors of 120 Ohm at both ends of the cable.

Via branch lines, further devices can be connected to the cable. The max. length of a branch line is 6 m. The entire length of the cable and all branch lines must not exceed the max. length listed in the following table.

Two different cable types exist. If both cables types are used within the same network, the max. length is calculated as follows:

Baud rate	Formula
125 kbit/s	$L_{\text{thick}} + 5 * L_{\text{thin}} \leq 500 \text{ m}$
250 kbit/s	$L_{\text{thick}} + 2.5 * L_{\text{thin}} \leq 250 \text{ m}$
500 kbit/s	$L_{\text{thick}} + L_{\text{thin}} \leq 100 \text{ m}$

Table 128: Formula for calculating the max. cable length for DeviceNet (thick and thin cable)

## 11.6 CC-Link

Use only a special cable that is approved for CC-Link. CC-Link specifies several shielded three-core Twisted Pair cables. We recommend using only one type of cable for an installation. Make sure that there are termination resistors at both ends of the cable. The value of the termination resistor depends on the cable type used and can be 100, 110 or 130 Ohm.

The following figure shows the general structure of the cable:

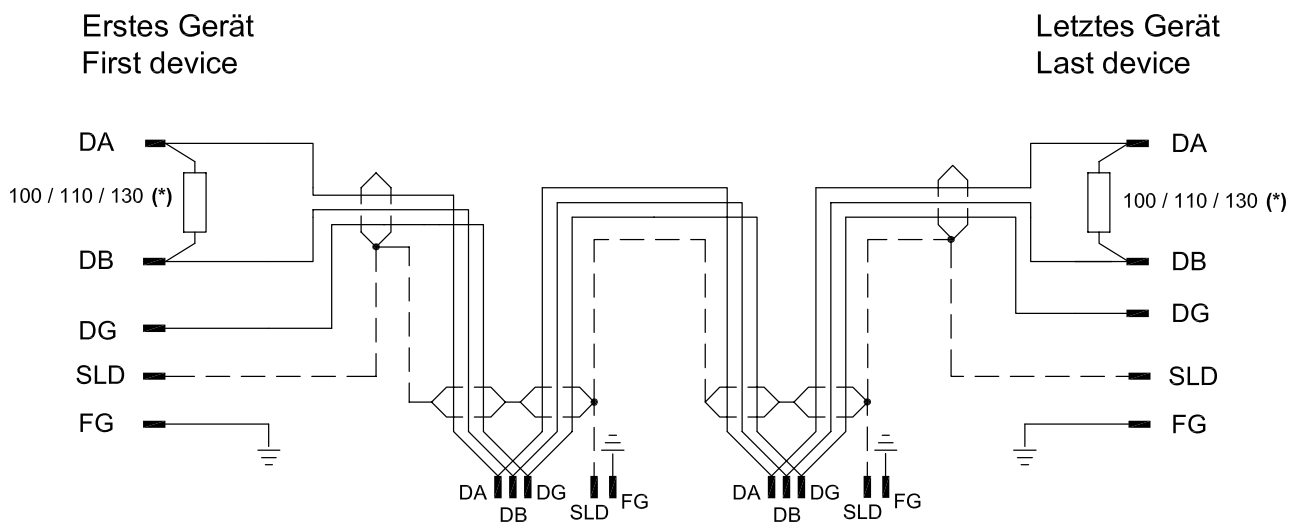

Figure 29: CC-Link cable

(\*) The termination resistor depends on the cable type used, see CC-Link Cable Wiring Manual.

The max. length of a bus segment depends on the baud rate used. The network structure can be built using a cable with or without branches. The "CC link Cable Wiring manual", July 2004, contains all details listed here. The manual contains further information and is available for download under CC0407-06-D on <http://www.cc-link.org>.

Cable specification V1.10 has not been changed for CC-Link V2.00.

Depending on the baud rate, the different cable types allow the following cable lengths:

### Only trunk line without branch lines

Baud rate	max. length, cable V1.00	max. length, cables V1.10 and V1.00 with high capacity	max. length, highly flexible, V1.10 (type 50%)
156 kbps	1200 m	1200 m	600 m
625 kbps	600 m	900 m	450 m
2.5 Mbps	200 m	400 m	200 m
5 Mbps	150 m	160 m	80 m
10 Mbps	100 m	100 m	50 m

Table 129: Max. length

Further cable types are available, but with these cable types only shorter max. lengths are possible.

### Trunk line with branch lines

Baud rate	156 kbps	625 kbps
max. length, trunk line	500 m	100 m
max. number of devices in branch line	6	6
max. cable length of branch line	8 m	8 m
max. length of all branch lines	200 m	50 m

Table 130: Max. length

Only at the baud rates 156 kbps and 625 kbps can further devices be connected to the bus cable via branch lines. The max. length of a branch line is 8 m. The entire length of the bus cable and all branch lines must not exceed the max. length listed in the following table.

### Min. cable length

Distance between CC-Link devices	CC-Link cable V1.00	CC-Link cable V1.10
Remote device to next remote device	0.3 m or more	0.2 m or more
Remote device to next Master or intelligent device	1 m or more	0.2 m or more

Table 131: Min. distance between two devices

### CC-Link cable housing

A CC-Link cable housing is included within the delivery of a netTAP NT 100-XX-CC gateway device. The cable housing is from Phoenix Contact, number 1803895, designation KGG-MSTB 2,5/5.

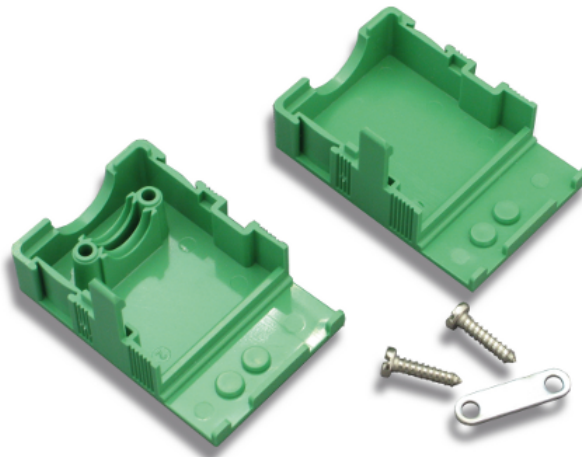

Figure 30: CC-Link cable housing – separate components

Use the delivered cable housing. The cable housing serves to protect the CC-Link communication line against EMC disturbances which might come in via the screws of the COMBICON connector.

### Assembly

- Place the Combicon connector with the screwed-down CC-Link cable into the lower part of the cable housing.
- Tighten the two screws to attach the strain relief of the CC-Link cable to the cable housing.
- Place the upper part of the cable housing onto the lower part to close the cable housing.

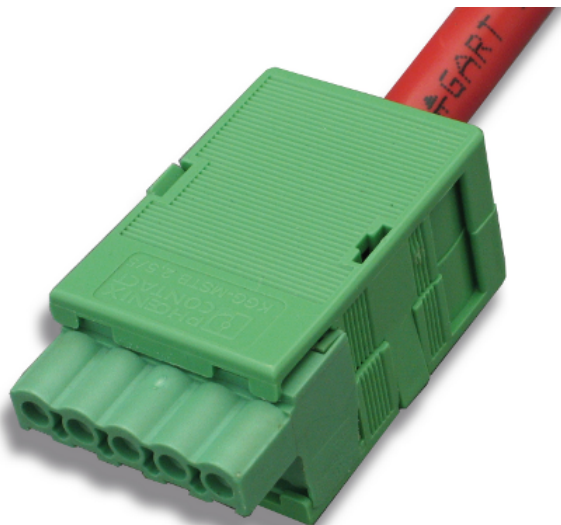

Figure 31: Mounted CC-Link cable housing

## 11.7 RS-232

The RS-232 interface (EIA-232) is a point-to-point connection of two communication devices. Use shielded cables. Termination resistors are not required.

Pay attention to the pin assignment of both communication partners. That decides on whether you need a so-called null modem cable with crossed pin assignments.

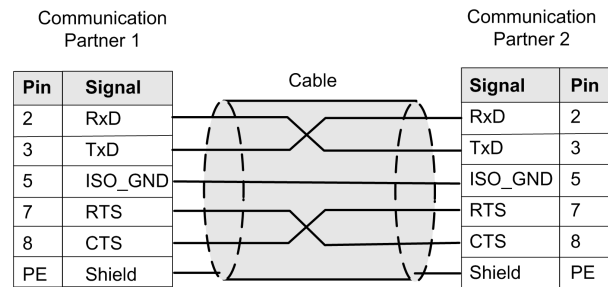

Figure 32: RS-232 null modem cable connection

The indications apply to a 9-pin D-Sub connector. Not all devices have RTS and CTS signals.

### Cable lengths and transmission rates

The EIA-232 specification allows a max. cable capacity for an RS-232 connection of max. 2500 pF and enables the following cable lengths depending on the baud rate:

Max. baud	Max. length
19200	15 m
57600	5 m
115200	< 2 m

Table 132: Max. cable length and baud rate with RS-232

Cables of a lower capacity allow even higher lengths.



## 11.8 RS-422

The lines of this industry bus interface are operated in push-pull action, four lines are required which can be controlled in half duplex or full duplex mode. This interface has been designed for one master and max. 10 slaves. Using repeaters allows even more slaves.

Cable lengths of up to 1.2 km (at low baud rates) and data transmission rates of up to 10 MBit/s (at a max. cable length of 12 m) are possible. The max. useable transmission rate depends on the technical data of the devices used.

The following figure shows an RS-422 wiring.

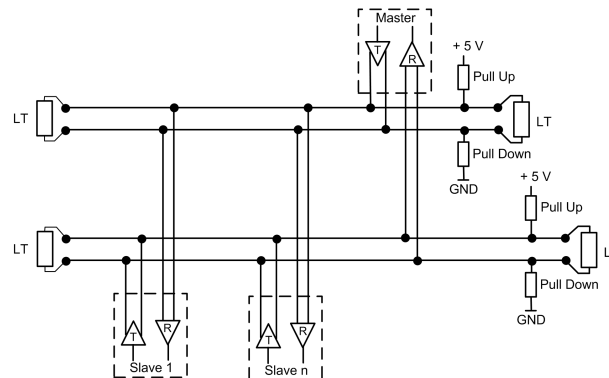

Figure 33: RS-422 cable

### Bus requirements

The bus cable must be a shielded 4-wire twisted pair cable. Each pair of wires has to be used for exactly one data transmission direction. The shield should be connected to the potential equalization system at both ends.

On each end, the bus requires a termination resistor (LT) of  $90\ \Omega$  to  $150\ \Omega$  between the lines. This value depends on the characteristic wave impedance of the cable. The pull-up and pull-down resistors should have a resistance of  $390\ \Omega$  to  $650\ \Omega$ .

### Cable requirements

The design of the bus cabling is essential for the reliable operation and electromagnetic compatibility (EMC). Always use shielded twisted pair cables. The shield of the cable must consist of a copper wire mesh.

Parameter	Value
Impedance	$150\ \Omega \pm 15\ \Omega$
Capacity	$< 30\ \text{pF/m}$
Loop resistance	$110\ \Omega/\text{km}$
Wire diameter	0.64 mm

Table 133: Electrical requirements: RS-422 cable

The following line lengths are possible:

Max. cable length	Baud rate	Max. branch line length
120 m	1 MBit/s	0.3 m
600 m	500 kBit/s	0.6 m
1200 m	100 kBit/s	1.5 m

Table 134: RS-422 cable lengths

## 11.9 RS-485

The lines of this industry bus interface are operated in push-pull action, only two lines are required which can be controlled in half duplex or full duplex mode. The major advantage of the 2-wire technology is its multi-master capability. In principle, each participant is able to exchange data with any other participant. However, the applied protocol must prevent two or more participants from sending at the same time. Using a protocol, the RS-485 interface allows the connection of up to 32 transmitters and receivers. With repeaters even more participants are possible.

RS-485 supports cable lengths of up to 1.2 km and data transmission rates of up to 1 MBit/s. The max. useable transmission rate depends on the technical data of the devices used.

The following figure shows an RS-485 wiring.

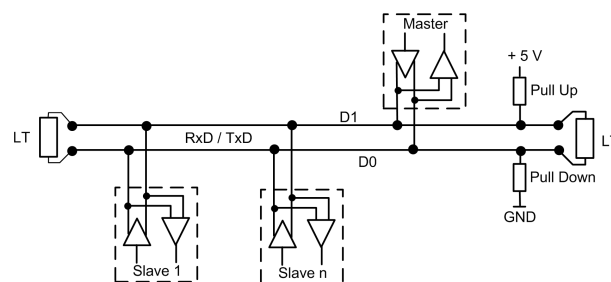

Figure 34: RS-485 cable

### Bus requirements

The bus cable must be a shielded twisted pair cable. The shield should have a large-scale connection to the potential equalization system at both ends.

On each end, between the lines D1 und D0, the bus requires a termination resistor (LT) whose value range corresponds to that of the wave impedance of the cable. Generally, the value of the termination resistor ranges between 120  $\Omega$  and 220  $\Omega$ .

The value of the pull-up and pull-down resistors ranges between 390  $\Omega$  and 650  $\Omega$ .

## Cable requirements

The design of the bus cabling is essential for the reliable operation and electromagnetic compatibility (EMC). Always use shielded twisted pair cables. The shield of the cable must consist of a copper wire mesh.

Parameter	Value
Impedance	150 $\Omega$ $\pm$ 15 $\Omega$
Capacity	< 30 pF/m
Loop resistance	110 $\Omega$ /km
Wire diameter	0.64 mm

Table 135: Electrical requirements: RS-485 cable

The following line lengths are possible:

Max. cable length	Baud rate	Max. branch line length
120 m	1 MBit/s	0.3 m
600 m	500 kBit/s	0.6 m
1200 m	100 kBit/s	1.5 m

Table 136: RS-485 cable lengths

# 12 Appendix

## 12.1 Legal notes

### Copyright

© Hilscher Gesellschaft für Systemautomation mbH

All rights reserved.

The images, photographs and texts in the accompanying materials (in the form of a user's manual, operator's manual, Statement of Work document and all other document types, support texts, documentation, etc.) are protected by German and international copyright and by international trade and protective provisions. Without the prior written consent, you do not have permission to duplicate them either in full or in part using technical or mechanical methods (print, photocopy or any other method), to edit them using electronic systems or to transfer them. You are not permitted to make changes to copyright notices, markings, trademarks or ownership declarations. Illustrations are provided without taking the patent situation into account. Any company names and product designations provided in this document may be brands or trademarks by the corresponding owner and may be protected under trademark, brand or patent law. Any form of further use shall require the express consent from the relevant owner of the rights.

### Important notes

Utmost care was/is given in the preparation of the documentation at hand consisting of a user's manual, operating manual and any other document type and accompanying texts. However, errors cannot be ruled out. Therefore, we cannot assume any guarantee or legal responsibility for erroneous information or liability of any kind. You are hereby made aware that descriptions found in the user's manual, the accompanying texts and the documentation neither represent a guarantee nor any indication on proper use as stipulated in the agreement or a promised attribute. It cannot be ruled out that the user's manual, the accompanying texts and the documentation do not completely match the described attributes, standards or any other data for the delivered product. A warranty or guarantee with respect to the correctness or accuracy of the information is not assumed.

We reserve the right to modify our products and the specifications for such as well as the corresponding documentation in the form of a user's manual, operating manual and/or any other document types and accompanying texts at any time and without notice without being required to notify of said modification. Changes shall be taken into account in future manuals and do not represent an obligation of any kind, in particular there shall be no right to have delivered documents revised. The manual delivered with the product shall apply.

Under no circumstances shall Hilscher Gesellschaft für Systemautomation mbH be liable for direct, indirect, ancillary or subsequent damage, or for any loss of income, which may arise after use of the information contained herein.

### Liability disclaimer

The hardware and/or software was created and tested by Hilscher Gesellschaft für Systemautomation mbH with utmost care and is made available as is. No warranty can be assumed for the performance or flawlessness of the hardware and/or software under all application conditions and scenarios and the work results achieved by the user when using the hardware and/or software. Liability for any damage that may have occurred as a result of using the hardware and/or software or the corresponding documents shall be limited to an event involving willful intent or a grossly negligent violation of a fundamental contractual obligation. However, the right to assert damages due to a violation of a fundamental contractual obligation shall be limited to contract-typical foreseeable damage.

It is hereby expressly agreed upon in particular that any use or utilization of the hardware and/or software in connection with

- Flight control systems in aviation and aerospace;
- Nuclear fission processes in nuclear power plants;
- Medical devices used for life support and
- Vehicle control systems used in passenger transport

shall be excluded. Use of the hardware and/or software in any of the following areas is strictly prohibited:

- For military purposes or in weaponry;
- For designing, engineering, maintaining or operating nuclear systems;
- In flight safety systems, aviation and flight telecommunications systems;
- In life-support systems;
- In systems in which any malfunction in the hardware and/or software may result in physical injuries or fatalities.

You are hereby made aware that the hardware and/or software was not created for use in hazardous environments, which require fail-safe control mechanisms. Use of the hardware and/or software in this kind of environment shall be at your own risk; any liability for damage or loss due to impermissible use shall be excluded.

### Warranty

Hilscher Gesellschaft für Systemautomation mbH hereby guarantees that the software shall run without errors in accordance with the requirements listed in the specifications and that there were no defects on the date of acceptance. The warranty period shall be 12 months commencing as of the date of acceptance or purchase (with express declaration or implied, by customer's conclusive behavior, e.g. putting into operation permanently).

The warranty obligation for equipment (hardware) we produce is 36 months, calculated as of the date of delivery ex works. The aforementioned provisions shall not apply if longer warranty periods are mandatory by law pursuant to Section 438 (1.2) BGB, Section 479 (1) BGB and Section 634a (1) BGB [Bürgerliches Gesetzbuch; German Civil Code] If, despite of all due care taken, the delivered product should have a defect, which already

existed at the time of the transfer of risk, it shall be at our discretion to either repair the product or to deliver a replacement product, subject to timely notification of defect.

The warranty obligation shall not apply if the notification of defect is not asserted promptly, if the purchaser or third party has tampered with the products, if the defect is the result of natural wear, was caused by unfavorable operating conditions or is due to violations against our operating regulations or against rules of good electrical engineering practice, or if our request to return the defective object is not promptly complied with.

### **Costs of support, maintenance, customization and product care**

Please be advised that any subsequent improvement shall only be free of charge if a defect is found. Any form of technical support, maintenance and customization is not a warranty service, but instead shall be charged extra.

### **Additional guarantees**

Although the hardware and software was developed and tested in-depth with greatest care, Hilscher Gesellschaft für Systemautomation mbH shall not assume any guarantee for the suitability thereof for any purpose that was not confirmed in writing. No guarantee can be granted whereby the hardware and software satisfies your requirements, or the use of the hardware and/or software is uninterrupted or the hardware and/or software is fault-free.

It cannot be guaranteed that patents and/or ownership privileges have not been infringed upon or violated or that the products are free from third-party influence. No additional guarantees or promises shall be made as to whether the product is market current, free from deficiency in title, or can be integrated or is usable for specific purposes, unless such guarantees or promises are required under existing law and cannot be restricted.

### **Confidentiality**

The customer hereby expressly acknowledges that this document contains trade secrets, information protected by copyright and other patent and ownership privileges as well as any related rights of Hilscher Gesellschaft für Systemautomation mbH. The customer agrees to treat as confidential all of the information made available to customer by Hilscher Gesellschaft für Systemautomation mbH and rights, which were disclosed by Hilscher Gesellschaft für Systemautomation mbH and that were made accessible as well as the terms and conditions of this agreement itself.

The parties hereby agree to one another that the information that each party receives from the other party respectively is and shall remain the intellectual property of said other party, unless provided for otherwise in a contractual agreement.

The customer must not allow any third party to become knowledgeable of this expertise and shall only provide knowledge thereof to authorized users as appropriate and necessary. Companies associated with the customer shall not be deemed third parties. The customer must obligate authorized

users to confidentiality. The customer should only use the confidential information in connection with the performances specified in this agreement.

The customer must not use this confidential information to his own advantage or for his own purposes or rather to the advantage or for the purpose of a third party, nor must it be used for commercial purposes and this confidential information must only be used to the extent provided for in this agreement or otherwise to the extent as expressly authorized by the disclosing party in written form. The customer has the right, subject to the obligation to confidentiality, to disclose the terms and conditions of this agreement directly to his legal and financial consultants as would be required for the customer's normal business operation.

### **Export provisions**

The delivered product (including technical data) is subject to the legal export and/or import laws as well as any associated regulations of various countries, especially such laws applicable in Germany and in the United States. The products / hardware / software must not be exported into such countries for which export is prohibited under US American export control laws and its supplementary provisions. You hereby agree to strictly follow the regulations and to yourself be responsible for observing them. You are hereby made aware that you may be required to obtain governmental approval to export, reexport or import the product.

## 12.2 Trademarks

Windows® 7, Windows® 8 and Windows® 10 are registered trademarks of the Microsoft Corporation.

Adobe-Acrobat® is a registered trademark of the Adobe Systems Incorporated.

CANopen® is a registered trademark of CAN in AUTOMATION - International Users and Manufacturers Group e.V (CiA), Nürnberg.

CC-Link is a registered trademark of Mitsubishi Electric Corporation, Tokyo, Japan.

DeviceNet™ and EtherNet/IP™ are trademarks of ODVA (Open DeviceNet Vendor Association, Inc).

EtherCAT® is a registered trademark and a patented technology of Beckhoff Automation GmbH, Verl, Federal Republic of Germany, formerly Elektro Beckhoff GmbH.

Modbus is a registered trademark of Schneider Electric.

POWERLINK is a registered trademark of B&R, Bernecker + Rainer Industrie-Elektronik Ges.m.b.H, Eggelsberg, Austria.

PROFIBUS® and PROFINET® are registered trademarks of PROFIBUS & PROFINET International (PI), Karlsruhe.

Sercos® and Sercos® interface are registered trademarks of Sercos International e. V., Süssen, Germany.

All other brands mentioned are property of their respective owner of the rights. Any company names and product designations provided in this document may be brands (company names or trademarks) of the corresponding owner and may be protected under trademark or patent law.



## List of figures

Figure 1:	netTAP operating principle .....	18
Figure 2:	Device name NT 100-RE-DP .....	19
Figure 3:	Device name (example).....	19
Figure 4:	LEDs and control elements (upper half of the device).....	30
Figure 5:	LEDs (lower half of the device).....	31
Figure 6:	RS-485 termination.....	38
Figure 7:	Galvanic isolation in case of NT 100-RE-XX devices.....	39
Figure 8:	Galvanic isolation NT 100-DP-XX / NT 100-CO-XX / NT 100-DN-XX devices.....	41
Figure 9:	Mounting the NT 100 .....	43
Figure 10:	Dismounting the NT 100 device from the DIN top hat rail .....	44
Figure 11:	Files for factory settings .....	49
Figure 12:	USB installation - Step 1.....	51
Figure 13:	USB installation - Step 2.....	51
Figure 14:	USB installation - Step 3.....	52
Figure 15:	USB installation - Step 4.....	52
Figure 16:	USB installation - Step 5.....	52
Figure 17:	USB installation - Step 6.....	53
Figure 18:	USB Installation Schritt 7 .....	53
Figure 19:	ComProX Start .....	54
Figure 20:	ComProX select connection .....	54
Figure 21:	ComProX File Explorer.....	54
Figure 22:	ComProX File Explorer, NT 100 file structure .....	55
Figure 23:	ComProX File Explorer, file menu 1 .....	55
Figure 24:	ComProX File Explorer, file menu 2 .....	56
Figure 25:	D-Sub cable assemblies.....	112
Figure 26:	PROFIBUS cable and termination.....	114
Figure 27:	CANopen cable and termination.....	115
Figure 28:	DeviceNet cable and termination.....	116
Figure 29:	CC-Link cable .....	117
Figure 30:	CC-Link cable housing – separate components.....	119
Figure 31:	Mounted CC-Link cable housing .....	119
Figure 32:	RS-232 null modem cable connection.....	120
Figure 33:	RS-422 cable.....	121
Figure 34:	RS-485 cable.....	122

## List of tables

Table 1:	List of revisions .....	5
Table 2:	Reference to device .....	6
Table 3:	Reference to software .....	6
Table 4:	Reference to driver .....	6
Table 5:	Directory structure of the Gateway Solutions DVD .....	7
Table 6:	Device description files for netTAP NT 100 .....	8
Table 7:	Basic documentation for netTAP NT 100 .....	9
Table 8:	Additional Documentation for netTAP NT 100 with EtherCAT Master .....	10
Table 9:	Additional Documentation for netTAP NT 100 with EtherNet/IP Scanner .....	10
Table 10:	Additional Documentation for netTAP NT 100 with PROFINET IO-Controller .....	10
Table 11:	Additional Documentation for netTAP NT 100 with sercos Master .....	10
Table 12:	Additional Documentation for netTAP NT 100 with CANopen Master .....	11
Table 13:	Additional Documentation for netTAP NT 100 with DeviceNet Master .....	11
Table 14:	Additional Documentation for netTAP NT 100 with PROFIBUS DP Master .....	11
Table 15:	Additional Documentation for netTAP NT 100 with netSCRIPT .....	12
Table 16:	Additional Documentation for netTAP NT 100 with ASCII .....	12
Table 17:	Additional Documentation for netTAP NT 100 with 3964R .....	12
Table 18:	netTAP devices: NT 100 .....	13
Table 19:	Signal words .....	17
Table 20:	Network on port X2 (primary network) .....	20
Table 21:	Network on port X3 (secondary network) .....	20
Table 22:	NT 100 for the conversion "Ethernet to Fieldbus" .....	21
Table 23:	NT 100 for the conversion "Ethernet to Serial" .....	23
Table 24:	NT 100 for the conversion "Fieldbus to Fieldbus" .....	24
Table 25:	NT 100 for the conversion "Fieldbus to Serial" .....	25
Table 26:	Device label .....	29
Table 27:	LEDs and control elements (upper half of the device) .....	30
Table 28:	Value range of the address switches .....	31
Table 29:	Value range of the address switches (CC-Link slave) .....	31
Table 30:	LEDs (lower half of the device) .....	31
Table 31:	Device drawings (left side, X2) .....	32
Table 32:	LED label (Real-Time Ethernet) .....	32
Table 33:	Device drawings (right side, X3) .....	33
Table 34:	Power supply .....	34
Table 35:	PROFIBUS interface (RS-485) .....	34
Table 36:	CANopen interface (ISO 11898) .....	35
Table 37:	DeviceNet interface .....	35
Table 38:	RJ45 Ethernet interface .....	36
Table 39:	CC-Link interface .....	36
Table 40:	RS-232 interface .....	37

Table 41:	RS-422 interface .....	37
Table 42:	RS-485 interface .....	37
Table 43:	Termination for RS-422 and RS-485 .....	38
Table 44:	USB interface (Mini-B) .....	38
Table 45:	Areas .....	39
Table 46:	Coupling of NT 100-RE-XX devices .....	40
Table 47:	Areas .....	41
Table 48:	Galvanic isolation NT 100-DP-XX / NT 100-CO-XX / NT 100-DN-XX devices .....	42
Table 49:	NT 100 troubleshooting .....	57
Table 50:	LED states System LED .....	59
Table 51:	APL LED states .....	60
Table 52:	APL LED state definitions .....	60
Table 53:	LED states for the EtherCAT Master (V4) protocol .....	61
Table 54:	LED state definitions for the EtherCAT Master (V4) protocol .....	62
Table 55:	LED states for the EtherCAT Slave protocol .....	63
Table 56:	LED state definitions for the EtherCAT Slave protocol .....	63
Table 57:	LED states for the EtherNet/IP Scanner protocol .....	64
Table 58:	LED state definitions for the EtherNet/IP Scanner protocol .....	65
Table 59:	LED states for the EtherNet/IP Adapter protocol .....	66
Table 60:	LED state definitions for the EtherNet/IP Adapter protocol .....	67
Table 61:	LED states for the OpenModbusTCP protocol .....	68
Table 62:	LED state definitions for the OpenModbusTCP protocol .....	68
Table 63:	LED states for the POWERLINK Controlled Node protocol .....	69
Table 64:	LED state definitions for the POWERLINK Controlled Node protocol .....	69
Table 65:	PROFINET IO Controller, SYS, COM0 and COM1 LEDs states .....	70
Table 66:	PROFINET IO Controller, Ethernet LEDs states .....	70
Table 67:	PROFINET IO Controller, LEDs states definitions .....	71
Table 68:	LED states for the PROFINET IO-Device protocol .....	72
Table 69:	LED state definitions for the PROFINET IO-Device protocol .....	72
Table 70:	LED states for the Sercos Master protocol .....	73
Table 71:	LED state definitions for the Sercos Master protocol .....	74
Table 72:	LED states for the Sercos Slave protocol .....	75
Table 73:	LED state definitions for the Sercos Slave protocol .....	76
Table 74:	LED states for the CANopen Master protocol .....	77
Table 75:	LED state definitions for the CANopen Master protocol .....	77
Table 76:	States of the CAN LED for the CANopen Slave protocol .....	78
Table 77:	LED state definitions for the CANopen Slave protocol .....	78
Table 78:	LED states for the CC-Link Slave protocol .....	79
Table 79:	LED states for the DeviceNet Master protocol .....	80
Table 80:	LED state definitions for the DeviceNet Master protocol .....	80
Table 81:	LED states for the DeviceNet Slave protocol .....	81

Table 82:	LED state definitions for the DeviceNet Slave protocol .....	81
Table 83:	LED states for the PROFIBUS DP Master protocol.....	82
Table 84:	LED state definitions for the PROFIBUS DP Master protocol .....	82
Table 85:	LED states for the PROFIBUS DP Master protocol.....	83
Table 86:	LED state definitions for the PROFIBUS DP Slave protocol .....	83
Table 87:	LED states for the Modbus/RTU Master protocol.....	84
Table 88:	LED states for the ASCII protocol.....	85
Table 89:	LED state definitions for the ASCII protocol .....	85
Table 90:	LED states for 'Serial with netSCRIPT' – Script is not executed .....	86
Table 91:	LED state definitions for the netSCRIPT protocol.....	86
Table 92:	LED states for 'Serial with netSCRIPT' – Script is executed .....	86
Table 93:	LED states for the 3964R protocol.....	87
Table 94:	LED state definitions for the 3964R protocol .....	87
Table 95:	Technical data NT 100 (part 1) .....	88
Table 96:	Technical data NT 100 (part 2) .....	89
Table 97:	Technical data NT 100 (part 3) .....	90
Table 98:	Technical data EtherCAT Master.....	91
Table 99:	Technical data EtherCAT Slave .....	92
Table 100:	Technical data EtherNet/IP Scanner .....	93
Table 101:	Technical data EtherNet/IP Adapter .....	94
Table 102:	Technical data Open Modbus/TCP.....	95
Table 103:	POWERLINK Controlled Node .....	95
Table 104:	Technical data PROFINET IO-Controller.....	96
Table 105:	Technical data PROFINET IO-Device .....	98
Table 106:	Technical data Sercos Master .....	99
Table 107:	Technical data Sercos Slave .....	100
Table 108:	Technical data CANopen Master.....	101
Table 109:	Technical data CANopen Slave.....	102
Table 110:	Technical data CC-Link Slave .....	103
Table 111:	Technical data DeviceNet Master.....	104
Table 112:	Technical data DeviceNet Slave.....	105
Table 113:	Technical data PROFIBUS DP Master .....	106
Table 114:	Technical data PROFIBUS DP Slave .....	107
Table 115:	Technical data ASCII .....	108
Table 116:	Technical data Modbus RTU Master/Slave .....	109
Table 117:	Technical data of serial protocols .....	110
Table 118:	Technical data 3964 .....	111
Table 119:	D-Sub cable assemblies.....	112
Table 120:	Use of hubs and switches.....	113
Table 121:	Max. cable length and baud rate for PROFIBUS.....	114
Table 122:	Electrical requirements: PROFIBUS cable .....	115

---

Table 123:	Electrical requirements: CANopen cable .....	115
Table 124:	Max. cable length and baud rate for CANopen.....	115
Table 125:	Max. cable length and baud rate for DeviceNet.....	116
Table 126:	Electrical requirements on DeviceNet data lines .....	116
Table 127:	Electrical requirements on DeviceNet power supply cables .....	116
Table 128:	Formula for calculating the max. cable length for DeviceNet (thick and thin cable)	117
Table 129:	Max. length .....	118
Table 130:	Max. length .....	118
Table 131:	Min. distance between two devices .....	118
Table 132:	Max. cable length and baud rate with RS-232.....	120
Table 133:	Electrical requirements: RS-422 cable .....	121
Table 134:	RS-422 cable lengths .....	122
Table 135:	Electrical requirements: RS-485 cable .....	123
Table 136:	RS-485 cable lengths .....	123

# Contacts

## HEADQUARTERS

### Germany

Hilscher Gesellschaft für  
Systemautomation mbH  
Rheinstrasse 15  
65795 Hattersheim  
Phone: +49 (0) 6190 9907-0  
Fax: +49 (0) 6190 9907-50  
E-mail: [info@hilscher.com](mailto:info@hilscher.com)

### Support

Phone: +49 (0) 6190 9907-99  
E-mail: [de.support@hilscher.com](mailto:de.support@hilscher.com)

## SUBSIDIARIES

### China

Hilscher Systemautomation (Shanghai) Co. Ltd.  
200010 Shanghai  
Phone: +86 (0) 21-6355-5161  
E-mail: [info@hilscher.cn](mailto:info@hilscher.cn)

### Support

Phone: +86 (0) 21-6355-5161  
E-mail: [cn.support@hilscher.com](mailto:cn.support@hilscher.com)

### France

Hilscher France S.a.r.l.  
69800 Saint Priest  
Phone: +33 (0) 4 72 37 98 40  
E-mail: [info@hilscher.fr](mailto:info@hilscher.fr)

### Support

Phone: +33 (0) 4 72 37 98 40  
E-mail: [fr.support@hilscher.com](mailto:fr.support@hilscher.com)

### India

Hilscher India Pvt. Ltd.  
Pune, Delhi, Mumbai  
Phone: +91 8888 750 777  
E-mail: [info@hilscher.in](mailto:info@hilscher.in)

### Italy

Hilscher Italia S.r.l.  
20090 Vimodrone (MI)  
Phone: +39 02 25007068  
E-mail: [info@hilscher.it](mailto:info@hilscher.it)

### Support

Phone: +39 02 25007068  
E-mail: [it.support@hilscher.com](mailto:it.support@hilscher.com)

### Japan

Hilscher Japan KK  
Tokyo, 160-0022  
Phone: +81 (0) 3-5362-0521  
E-mail: [info@hilscher.jp](mailto:info@hilscher.jp)

### Support

Phone: +81 (0) 3-5362-0521  
E-mail: [jp.support@hilscher.com](mailto:jp.support@hilscher.com)

### Korea

Hilscher Korea Inc.  
Seongnam, Gyeonggi, 463-400  
Phone: +82 (0) 31-789-3715  
E-mail: [info@hilscher.kr](mailto:info@hilscher.kr)

### Switzerland

Hilscher Swiss GmbH  
4500 Solothurn  
Phone: +41 (0) 32 623 6633  
E-mail: [info@hilscher.ch](mailto:info@hilscher.ch)

### Support

Phone: +49 (0) 6190 9907-99  
E-mail: [ch.support@hilscher.com](mailto:ch.support@hilscher.com)

### USA

Hilscher North America, Inc.  
Lisle, IL 60532  
Phone: +1 630-505-5301  
E-mail: [info@hilscher.us](mailto:info@hilscher.us)

### Support

Phone: +1 630-505-5301  
E-mail: [us.support@hilscher.com](mailto:us.support@hilscher.com)