

SLPE14-690

Personnel Safety, Light Screen – Emitter

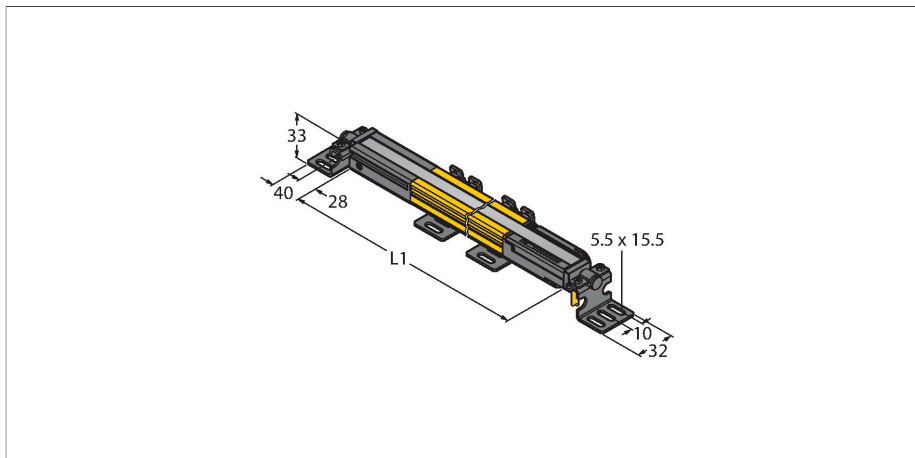

Technical data

Type	SLPE14-690
ID	3083635
Optical data	
Function	Light screen
Light type	IR
Wavelength	850 nm
Optical resolution	14 mm
Range	100...7000 mm
Scan field	690 mm
Number of beams	69
With muting function	no
Scan Code	Adjustable
Electrical data	
Operating voltage	20...28 VDC
Residual ripple	< 10 % U _{ss}
DC rated operational current	≤ 60 mA
Current consumption non-actuated	≤ 60 mA
No-load current	≤ 100 mA
Short-circuit protection	yes
Reverse polarity protection	yes
Response time typical	< 19.5 ms
Blanking function	yes
Mechanical data	
Design	Rectangular, EZ-Screen LP
Dimensions	26 x 28 x 689 mm
Housing material	Metal, AL, Yellow polyester
Lens	plastic, Acrylic

Features

- Electrical connection via RDLP-8 with open end or via DELPE-8 with male M12 × 1, 8-pin
- Protection class IP65
- Flat housing without blind zone
- Scan code adjustable via DIP switch
- Operating voltage: 24 VDC ± 15 %
- Resolution 14 mm
- Scan field 690 mm (L1)
- Personnel safety Cat 4, PL e acc. to EN ISO 13849-1:2008
- Type 4 according to IEC 61496-1,-2
- SIL 3 to IEC 61508

Wiring diagram

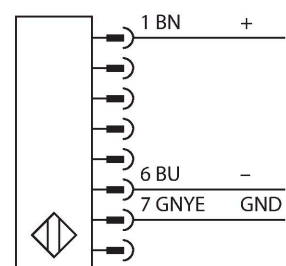

Functional principle

The high-resolution safety light curtain is emitter and receiver in one without blind zone. As the system is synchronized optically, wiring between emitter and receiver is redundant. The safety switching outputs of the receiver are directly connected to a load relay (e.g. IM-TA9A) and trigger an immediate stop of the dangerous machine cycle. The switching device with 2-channel monitoring, diverse redundant designed and mutual processor control, complies with the personnel safety category PLe acc. to ISO 13849-1.

Technical data

Cascadable	No
Electrical connection	Cable entry for flat connector
Ambient temperature	0...+55 °C
Protection class	IP65
Power-on indication	LED, Green
Switching state	2-color LED, Red
Tests/approvals	
Vibration resistance	10-55 Hz at 0.35 mm
Shock test	10 g at 16 ms (6000 cycles)
Approvals	CE, cTUVus, PL e acc. to ENISO 13849-1:2008, SIL 3 acc. to IEC 61508

Accessories

LPA-MBK-11	3082841	LPA-MBK-12	3082842
	Mounting bracket, retainer for closure caps, 14-ga. steel, galvanized, black, 360 ° sensor rotation, incl.2 pcs. with screw set		Mounting bracket, side mounting, 14-ga. steel, galvanized, black, +10°/-30° sensor rotation, incl.1 pcs. with screw set
LPA-MBK-20	3082853	LPA-MBK-22	3082844
	Mounting bracket, wall mounting, 12-ga. steel, galvanized, black, in combination with LPA-MBK-11/ -12/ -13, incl. 1 pcs. and screw set		Mounting bracket, wall mounting, 14-ga. steel, galvanized, black, in combination with LPA-MBK-11, incl. 2 pcs. and screw set

Accessories

Dimension drawing	Type	ID	
	RDLP-815D	3080792	Connection cable, PVC, yellow, length: 4.57 m, RD connector for direct connection to the light screen
	RDLP-825D	3080793	Connection cable, PVC, yellow, length: 7.62 m, RD connector for direct connection to the light screen
	RDLP-850D	3080794	Connection cable, PVC, yellow, length: 15.2 m, RD connector for direct connection to the light screen
	RDLP-875D	3080795	Connection cable, PVC, yellow, length: 22.9 m, RD connector for direct connection to the light screen
	DELPE-81D	3080811	Connection cable, PVC, yellow, length: 0.31 m, RD connector for direct connection on male M12 x 1, 8-pin,
	DELPE-83D	3080812	Connection cable, PVC, yellow, length: 0.91 m, RD connector for direct connection on male M12 x 1, 8-pin,
	DELPE-88D	3080813	Connection cable, PVC, yellow, length: 2.44 m, RD connector for direct connection on male M12 x 1, 8-pin,
	DELPE-815D	3080814	Connection cable, PVC, yellow, length: 4.57 m, RD connector for direct connection on male M12 x 1, 8-pin,
	DELPE-825D	3080815	Connection cable, PVC, yellow, length: 7.62 m, RD connector for direct connection on male M12 x 1, 8-pin,

Dimension drawing	Type	ID	
	DELPE-850D	3080816	Connection cable, PVC, yellow, length: 15.2 m, RD connector for direct connection on male M12 x 1, 8-pin,
	DELPE-875D	3080817	Connection cable, PVC, yellow, length: 22.9 m, RD connector for direct connection on male M12 x 1, 8-pin,
	DELPE-8100D	3080818	Connection cable, PVC, yellow, length: 30.5 m, RD connector for direct connection on male M12 x 1, 8-pin,
	CSB-M1280M1280	3075375	Y-piece, PVC, yellow, with male M12 x 1, 8-pin on 2 x 0.3 m cable, PVC, yellow, with female M12 x 1, 8-pin
	CSB-M1281M1281	3073252	Y-piece, PVC, yellow, length: 0.3 m with male, M12 x 1, 8-pin on 2 x 0.3 m cable, PVC, yellow, with female, M12 x 1, 8-pin
	CSB-M1288M1281	3073253	Y-piece, PVC, yellow, length: 2.5 m with male, M12 x 1, 8-pin on 2 x 0.3 m cable, PVC, yellow, with female, M12 x 1, 8-pin
	CSB-M12815M1281	3073254	Y-piece, PVC, yellow, length: 4.6 m with male, M12 x 1, 8-pin on 2 x 0.3 m cable, PVC, yellow, with female, M12 x 1, 8-pin
	CSB-M12825M1281	3073255	Y-piece, PVC, yellow, length: 7.6 m with male, M12 x 1, 8-pin on 2 x 0.3 m cable, PVC, yellow, with female, M12 x 1, 8-pin