

# ROTEC

Commutatori a camme e Ausiliari di comando  
*Cam switches and Control switches*

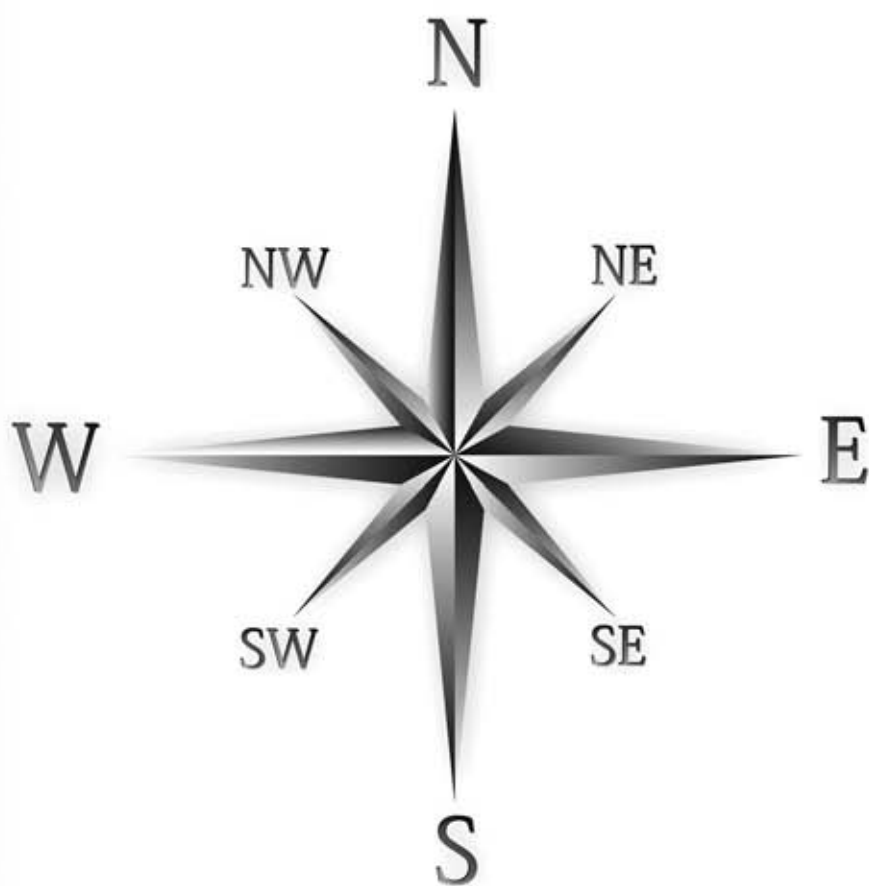

**ITALWEBER**  
Un mondo di protezione



**ITALWEBER**  
Un mondo di protezione

**COMMUTATORI A CAMME | CAM SWITCHES**



**Serie CS 16-315A**

Interruttori / Switches	10
Commutatori di linea / Changeover switches	13
Commutatori per motori / Motor switches	15
Commutatori multivie / Multi-step switches	16
Commutatori voltmetrici / amperometrici / Voltmeter / ammeter switches	17
Dimensioni e dime di foratura / Dimensions and fixing holes	18
Caratteristiche tecniche / Technical characteristics	20

**Serie CP 12-16A**

Interruttori con morsetti IP20 / Switches with IP20 terminals	24
Commutatori di linea con morsetti IP20 / Changeover switches with IP20 terminals	25
Commutatori per motori con morsetti IP20 / Motor switches with IP20 terminals	28
Commutatori voltmetrici / amperometrici con morsetti IP20 / Voltmeter / ammeter switches with IP20 terminals	29
Dimensioni / Dimensions	30
Caratteristiche tecniche / Technical characteristics	31



Accessori serie CS/CP / Accessories for CS/CP series	32
Schemi elettrici serie CS/CP / Electrical diagrams for CS/CP series	36
Modulo richiesta schemi speciali / Special versions request form	39

**AUSILIARI DI COMANDO | CONTROL SWITCHES**

**Serie PM ø 22mm**

Lampade di segnalazione LED monoblocco / Monoblock LED indicators	42
Pulsanti monoblocco non luminosi / Monoblock operators unlighted	43
Selettore monoblocco non luminosi / Monoblock selector switches unlighted	44
Ronzatori, potenziometri e puls. multifunzione / Buzzers, potentiometers and multifunction pushbuttons	45
Pulsanti di emergenza monoblocco e modulari / Monoblock and modular emergency stop	46
Pulsanti di emergenza in cassetta / Emergency stop in enclosure	47
Pulsantiere di emergenza 3 fori / Emergency pushbutton stations 3 holes	48
Pulsantiere di manutenzione ascensori 4 e 5 fori / Inspection pushbutton stations 4 and 5 holes	49
Pulsantiere vuote da 1 a 5 fori / Pushbutton stations from 1 to 5 holes	50
Caratteristiche tecniche / Technical characteristics	51



**Serie PR ø 22mm**

Pulsanti luminosi/non luminosi corpo in metallo elemento frontale tondo <i>Illuminated-non illuminated pushbuttons with metal body and rounded front element</i>	56
Selettori luminosi/non luminosi corpo in metallo 2, 3 posizioni elemento frontale tondo <i>Illuminated-non illuminated selectors 2/3 positions with metal body and rounded front element</i>	58
Manipolatori 3, 5 posizioni, corpo in metallo, elemento frontale tondo <i>Joystick operators, 3/5 positions, with metal body and rounded front element</i>	59
Pulsanti luminosi/non luminosi corpo in termoplastico <i>Illuminated-non illuminated pushbuttons with thermoplastic body</i>	60
Pulsanti non luminosi, indicatori luminosi e comando potenziometro in termoplastico <i>Non-illuminated pushbuttons, illuminated indicators and potentiometer control with thermoplastic body</i>	61
Selettori non luminosi 2, 3 posizioni corpo in termoplastico <i>Illuminated-non illuminated selectors 2/3 positions with thermoplastic body</i>	62
Pulsanti di emergenza / Emergency pushbuttons	63
Custodie isolanti a doppio isolamento con fori ø 22 o ø 30 / Double insulation enclosures with ø 22 or ø 30 holes	64
Custodie isolanti a doppio isolamento con pulsanti ø 22 / Double insulation enclosures with ø 22 holes	65



**Serie PF**

Pulsanti in termoplastico e in metallo 10A 380V / Pushbuttons with thermoplastic or metal body 10A 380V	66
---	----

**Serie P ø 22mm e ø 30mm**

Elementi di contatto e alimentazioni / Contacts blocks and power supplies	67
Accessori / Accessories	68
Targhette / Legend plates	69
Caratteristiche tecniche / Technical characteristics	71



# COMMUTATORI A CAMME

## CAM SWITCHES



- Impiego per interruzione, commutazione, inserzione ed avviamento di circuiti con carichi elettrici induttivi o resistivi, con portate da 5A a 315A
- Elevata resistenza meccanica ed alle correnti superficiali, stabilità dimensionale
- Elementi componibili
- Contatti ad apertura forzata/positiva in lega d'argento a doppia interruzione
- Morsetti di collegamento a vite per conduttori con o senza capicorda, chiaramente identificabili
- Ampia gamma di dispositivi e accessori per la realizzazione di numerose versioni
- Qualità ed affidabilità per la massima sicurezza di funzionamento dei circuiti di comando e di controllo
- Economicità e semplicità di utilizzo
- Conformità alle normative nazionali ed internazionali
- Grado di protezione IP secondo IEC/EN 60529
- Protezione frontale massima IP66
- Condizioni d'impiego in ambienti caldo umidi
- Altitudine d'impiego 2.000m
- Funzionamento in tutte le posizioni di montaggio
- Protezione IP20 ai morsetti per i prodotti indicati
- Materiali plastici esenti da amianto e cadmio
- Varie opzioni di colore degli attuatori
- Lunga vita dei contatti grazie all'azione di autopulitura del contatto mobile durante la manovra
- Temperatura di funzionamento -25...+60 °C

- *Use for breaking, changing-over, making and starting of circuits with inductive or resistive electric loads; rated loads from 5A up to 315A*
- *High resistance to mechanical stress and to surface currents, dimensional stability*
- *Modular elements*
- *Double break silver alloy contacts*
- *Screw terminals for cables with/without cable terminal, of easy identification*
- *Wide range of products and accessories to obtain many different versions*
- *Quality and reliability for the highest safety of operation on control circuits*
- *Convenience and practical use*
- *Compliance with national and international standards*
- *IP protection degree according to IEC/EN 60529*
- *Maximum frontal protection IP66*
- *Conditions of use in hot humid environments*
- *Maximum use altitude: 2000 m*
- *They can be used in every mounting positions*
- *IP20 terminals protection for the products indicated*
- *Plastic materials free of amianto and cadmium*
- *Various colour options for the actuators*
- *Long contacts life thanks to the self-cleaning action of the moving contact during the operation*
- *Operating temperature -25...+60 °C*

## Categorie d'impiego | Utilization categories

Per la scelta del tipo di commutatore oppure dell'elemento di contatto più idoneo, in base alla specifica applicazione, è necessario raffrontare i valori di esercizio (tensione e corrente o potenza) dell'unità da comandare con le prestazioni del commutatore o dell'elemento di contatto. Per effettuare tale raffronto fare riferimento alle categorie di utilizzo secondo le norme IEC/EN60947-1-3, 60947-5-1, 60204-1 indicate nelle pagine tecniche.

*To choose the most suitable and economic cam-switch in relation to the specific application it is necessary to compare the operating parameters of the unit to be controlled (voltage, current and power) with the cam switch performance. To make this comparison consult the IEC/EN 60947-1-3, 60947-5-1, 60204-1, specifications for the utilization categories as indicated in the technical pages.*



### Motori asincroni a gabbia | Cage induction motors

kW	Ampère			
	230V	400V	500V	690V
0,06	0,41	0,24	0,19	0,14
0,09	0,62	0,36	0,29	0,21
0,12	0,83	0,48	0,38	0,28
0,18	1,16	0,67	0,54	0,39
0,25	1,43	0,83	0,66	0,48
0,37	1,90	1,10	0,88	0,64
0,55	2,67	1,55	1,24	0,90
0,75	3,45	2,00	1,60	1,16
1,10	4,75	2,75	2,20	1,60
1,50	6,05	3,50	2,80	2,05
2,20	8,45	4,90	3,90	2,85
3,00	11,70	6,80	5,40	3,90
4,00	15,00	8,70	7,00	5,00
5,50	19,50	11,30	9,10	6,50
7,50	25,50	14,80	11,90	8,60
11,00	37,00	21,50	17,00	12,50
15,00	50,00	29,00	23,00	17,00
18,50	60,50	35,00	28,00	20,50
22,00	72,50	42,00	33,50	24,50
30,00	97,50	56,50	45,00	32,50
37,00	117,00	68,00	54,50	39,50
45,00	141,00	82,00	64,00	47,00
55,00	173,00	100,50	80,00	57,00
75,00	229,00	133,00	106,00	77,00
90,00	272,00	158,00	126,00	91,00
110,00	333,00	193,00	153,00	110,00

Valori di assorbimento per motori trifase in c.a. (4 poli 1500 giri/minuto)  
Absorption values for three-phase motors in a.c. (4 poles 1500 rpm)

Le categorie d'impiego più comuni sono le seguenti:  
*The most common utilization categories are the following:*

- AC-1 Carichi non induttivi o debolmente induttivi, forni a resistenza / *Non-inductive or slightly inductive loads, resistance furnaces*
- AC-3 Motori a gabbia: avviamento, arresto di motore durante la rotazione / *Squirrel-cage motors: starting switching off motors during running*
- AC-4 Motori a gabbia: avviamento, frenatura di contro corrente, manovra a impulsi / *Squirrel-cage motors: starting, reversing, electric breaking, inching*
- AC-12 Carichi resistivi e carichi a stato solido opto-isolati / *Control of resistive loads and solid state loads with isolation by optocouplers*
- AC-13 Carichi a stato solido con trasformatore di isolamento / *Control of solid state loads with transformer isolation*
- AC-15 Comando di carichi elettromagnetici in corrente alternata (>72VA) / *Control of alternate current electromagnetic loads (>72VA)*
- AC-20 Chiusura ed interruzione a vuoto / *Connecting and disconnecting under no-load condition*
- AC-21 Manovra di carichi resistivi con sovraccarichi di modesta entità / *Switching of resistive loads, including moderate overloads*
- AC-22 Manovra di carichi misti, resistivi ed induttivi con sovraccarichi di modesta entità / *Switching of mixed resistive and inductive loads, including moderate overloads*
- AC-23 Manovra di motori o altri carichi altamente induttivi / *Switching of motor loads or other highly inductive loads*
- DC-1 Carichi non induttivi o debolmente induttivi, forni a resistenza / *Non-inductive or slightly inductive loads, resistance furnaces*
- DC-3 Motori in derivazione, avviamento, frenatura in contro corrente, manovra a impulsi, frenatura dinamica di motori / *Shunt-motors, starting, plugging, inching, dynamic breaking of motors*
- DC-5 Motori in serie, avviamento, frenatura in contro corrente, manovra a impulsi, frenatura / *Series-motors, starting, plugging, inching, dynamic breaking of motors*
- DC-12 Carichi resistivi e carichi a stato solido opto-isolati / *Control of resistive loads and solid state loads with isolation by optocouplers*
- DC-13 Comando di elettromagneti in corrente continua / *Control of direct current electromagnets*
- DC-20 Chiusura ed interruzione a vuoto / *Connecting and disconnecting under no-load conditions*
- DC-21 Manovra di carichi resistivi con sovraccarichi di modesta entità / *Switching of resistive loads, including moderate overloads*
- DC-22 Manovra di carichi misti, resistivi ed induttivi con sovraccarichi di modesta entità (es. motori in derivazione) / *Switching of mixed resistive and inductive loads, including moderate overloads (e.g. shunt motors)*
- DC-23 Manovra di motori o altri carichi altamente induttivi (es. motori in serie) / *Switching of highly inductive loads (e.g. series motors)*

## Applicazioni tipiche dei commutatori

### Interruttori

Sono interruttori usati per collegare-interrompere qualsiasi tipo di circuito elettrico. Vengono utilizzati in un'ampia gamma di applicazioni come ad esempio il comando di motori oppure il sezionamento di circuiti elettrici.

### Commutatori di linea

Sono commutatori a 3 posizioni utilizzati per alimentare un carico alternando due alimentazioni indipendenti. L'utilizzo tipico di questi apparecchi riguarda il controllo di carichi che possono usufruire di un'alimentazione principale ed una ausiliaria.

### Commutatori a più vie

Sono commutatori a 2 o più posizioni che permettono di collegare carichi indipendenti ad un'unica sorgente di alimentazione.

### Invertitori di Marcia

Sono commutatori che permettono di comandare manualmente e direttamente il senso di rotazione del motore, tramite l'inversione delle fasi di alimentazione.

### Commutatori di poli Dahlander

Sono commutatori che permettono di variare manualmente la velocità di rotazione del motore, variando la configurazione delle fasi di alimentazione ed agendo sul numero di poli.

### Commutatori Stella-Triangolo

Sono commutatori che consentono manualmente di ridurre la tensione applicata al motore nella fase di avviamento, agendo sul collegamento delle fasi di alimentazione.

## Changeover switches typical applications

### Switches

*Switches used to connect-interrupt any type of electric circuit. They are used in a wide range of applications such as motor control or the disconnection of electrical circuits.*

### Changeover switches

*3-position switches that are used to power a load alternating two independent power supplies. The typical use of these devices involves the monitoring of loads that can benefit of a main supply and an auxiliary supply.*

### Multi-step switches

*Multi-position switches used to connect a variety of loads to an electrical supply.*

### Reversing switches

*Three-position switches used to manually control the direction of rotation of a motor, by means of the reversion of the supply phases.*

### Dahlander switches

*They are switches which allow to manually vary the speed of rotation of the motor, by varying the configuration of the supply phases of the motor and acting on the number of poles.*

### Star-Delta Switches

*Three-position switches used to manually reduce the voltage starting value of a motor, acting on the connection of the supply phases.*

## Equipaggiamento elettrico delle macchine IEC/EC 60204

### DISPOSITIVO DI SEZIONAMENTO DELL'ALIMENTAZIONE

Per ogni alimentazione si deve prevedere un dispositivo di sezionamento a comando manuale che permetta, quando richiesto, la separazione dell'equipaggiamento elettrico della macchina all'alimentazione.

Il dispositivo di sezionamento deve essere uno dei seguenti tipi:

- un interruttore-sezionatore conforme alla norma EN 60947-3: nella categoria AC-23 o DC-23;
- un sezionatore con un contatto ausiliario che, mediante dispositivi di interruzione, provochi in tutti i casi l'interruzione del circuito di carico prima dell'apertura dei contatti principali del sezionatore.

### Il dispositivo di sezionamento dell'alimentazione deve soddisfare tutte le seguenti prescrizioni:

- isolare l'equipaggiamento elettrico dall'alimentazione ed avere una sola posizione di aperto e di chiuso, chiaramente marcata con "0" e "1";
- avere un'apertura visibile, oppure un indicatore di posizione che possa segnalare la posizione di aperto soltanto se tutti i contatti sono effettivamente aperti e dove esista un'adequata distanza

## Safety of machinery - Electrical equipment of machines IEC/EN 60204

### SWITCH DISCONNECTOR DEVICE

*For each power supply must be provided a disconnection device with manual control that, when required, allows the separation of the electrical equipment of the machine from the supply.*

*The disconnecting device must be one of the following types:*

- a switch-disconnector in accordance with EN 60947-3: utilization category AC-23 or DC-23;
- a switch disconnector with an auxiliary contact that, by means of some interrupting devices, cause in all cases the interruption of the load circuit before the opening of the main contacts of the disconnector.

### The disconnection device must meet all the following requirements:

- isolate the electrical equipment from the supply having a single open or closed position, clearly marked with "0" and "1";
- have a visible opening, or a position indicator that can signal the open position only if all the contacts are actually open and if there is an adequate isolation distance between all contacts in accordance with EN 60947-3;

- di isolamento tra tutti i contatti, conformemente alla norma EN 60947-3;
- interrompere tutti i conduttori attivi del suo circuito di alimentazione; tuttavia, nei sistemi di alimentazione TN, il conduttore di neutro può essere scollegato oppure collegato;
- avere un potere di interruzione sufficiente per interrompere la corrente a rotore bloccato del motore di maggior potenza ed in più la somma delle correnti di funzionamento nominale di tutti gli altri motori e/o carichi;
- avere una maniglia di azionamento esterna. Quando il sezionatore non viene utilizzato anche come dispositivo di arresto di emergenza, la maniglia di emergenza non deve essere colore rosso; si raccomandano i colori nero e grigio;
- essere munito di un dispositivo che permetta di bloccarlo nella posizione di aperto (es. mediante lucchetto).

### Dispositivi di sezionamento dell'alimentazione come dispositivi di arresto di emergenza

I dispositivi di arresto di emergenza devono essere posizionati in ogni stazione di comando ed in altri punti operativi in cui può essere richiesto un arresto di emergenza. Non deve essere possibile ripristinare il circuito fino a che l'attuatore del dispositivo di arresto di emergenza non sia stato riarmato manualmente. Quando sono previsti diversi dispositivi di arresto di emergenza, il circuito non deve essere ripristinato fino a che tutti gli attuatori azionati in precedenza non sono stati riarmati. I contatti dei dispositivi di arresto di emergenza azionati a mano devono assicurare una manovra di apertura positiva. Gli attuatori dei dispositivi di arresto di emergenza devono essere di colore rosso. Se esiste uno sfondo dietro l'attuatore del dispositivo, esso deve essere di colore giallo.

### Dispositivi di interruzione per la prevenzione di avviamenti imprevisti

Si devono prevedere dispositivi di interruzione a prevenzione di avviamenti imprevisti nei casi in cui si possano verificare delle situazioni pericolose nel caso di un avviamento imprevisto (ad esempio se durante una manutenzione avvenisse un avviamento). Un dispositivo di sezionamento dell'alimentazione può soddisfare questa funzione. Tali dispositivi devono essere adatti ed appropriati all'uso cui sono destinati, devono essere correttamente posizionati e chiaramente identificati.

### Dispositivi di sezionamento dell'alimentazione usati come dispositivi di arresto di emergenza

In alcune macchine semplici il dispositivo di sezionamento dell'alimentazione può avere la funzione di un dispositivo di arresto di emergenza. In tali casi dovrà soddisfare anche le prescrizioni per dispositivi di arresto di emergenza.

#### DEFINIZIONI

**Sezionatori:** dispositivi meccanici capaci di isolare il carico dell'alimentazione. Nella posizione di aperto devono garantire una sufficiente distanza di isolamento.

**Interruttori:** dispositivi meccanici con potere di apertura e chiusura della corrente di esercizio.

**Interruttori-Sezionatori:** Interruttori che rispondono alle richieste di isolamento dei sezionatori.

- stop all active conductors of its power circuit; but in TN power systems, the neutral conductor can be connected or disconnected;
- have a breaking capacity sufficient to stop the locked rotor current of the most powerful motor and of the sum of the nominal operating currents of all other motors and / or loads;
- have an external operating handle. When the switch is not used as a device for emergency stop, the emergency handle must not be red, we recommend the black and gray colours;
- having a device that allows to lock it in open position (eg by means of a padlock).

### Disconnecting device for devices such as emergency stop

Emergency stop devices must be placed in each control station and in other operating points in which may be required an emergency stop. It must not be possible to restore the circuit until the actuator of the emergency stop device has been manually reset. When there are different emergency stop devices, the circuit should not be restored until all the actuators previously operated have not been rearmed. The contacts of the emergency stop devices operated by hand must ensure positive opening operation. The actuators of emergency stop devices shall be of red colour. If there is a background behind the actuator of the device, it must be yellow.

### Switching devices for the prevention of unexpected start-ups

Switching devices must be provided in order to prevent unexpected start-ups in cases where dangerous situations can occur in the case of unexpected start-up (for example if, during a maintenance operation, a start-up will occur). A supply disconnecting device can fulfill this function. These devices must be suitable and appropriate to their intended use, they must be properly positioned and clearly identified.

### Supply disconnecting device used as emergency stop devices

In some simple machines the supply disconnecting device may have the function of an emergency stop device. In such cases it must also meet the requirements for emergency stop devices.

#### DEFINITIONS

**Disconnectors:** mechanical devices capable of isolating the power load. In open position they must guarantee a sufficient insulation distance.

**Switches:** mechanical devices with the power to open and close the flowing current.

**Switch-Disconnectors:** Switches that respond to the specifications regarding the insulation of disconnectors.

## Normative

Costruiti in conformità agli standard IEC/EN 60947-1, 60947-3, 60947-5-1, CSA 22.1-14, UL 508, 486E. Corrispondono alle esigenze tecniche e di sicurezza in conformità ai requisiti delle direttive 2006/95/CE riguardo alla libera circolazione di apparecchiature elettriche nell'ambito della Comunità Europea. Inoltre rispondono alle prescrizioni della direttiva 2004/108/CE relativa alla compatibilità elettromagnetica (EMC). Per la sicurezza dell'utente gli apparecchi devono essere scelti, installati ed impiegati osservando scrupolosamente i limiti d'impiego indicati nel presente catalogo; nonchè alle normative nazionali ed internazionali riguardanti la sicurezza delle apparecchiature o degli impianti sui quali devono essere utilizzati.

## Standards

Manufactured in accordance with IEC / EN 60947-1, 60947-3, 60947-5-1, CSA 22.1-14, UL 508, 486E. They correspond to the technical and safety requirements in accordance with Directive 2006/95/EC that refers to the free circulation of electrical equipments within the European Community. Also meet the requirements of Directive 2004/108/CE relating to electromagnetic compatibility (EMC). For user safety, the equipments must be selected, installed and used following the characteristics and limitations indicated in this catalog, as well as the national and international regulations concerning the safety of the equipments or facilities in which they must be used.



Prodotti speciali per il settore ferroviario

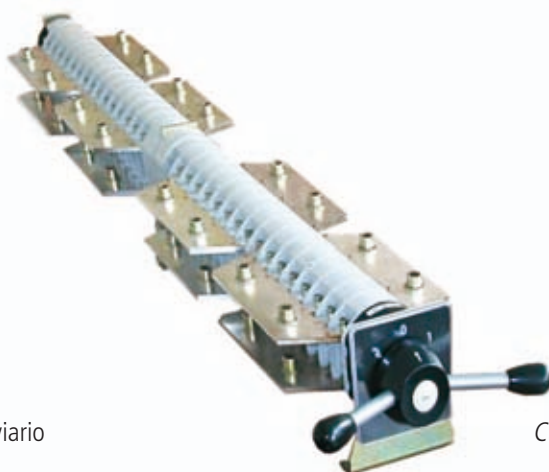

Custom products for railway application



## Gradi di protezione degli involucri IEC/EN 60529 | IP enclosure protection degree according to IEC/EN 60529

### 1<sup>a</sup> cifra | 1<sup>st</sup> digit

#### Protezione contro corpi solidi Protection against ingress of solid bodies

- 0** Nessuna protezione / No protection
- 1** Non deve penetrare una sfera di Ø 50mm / Protected against the penetration of a sphere with a diameter of 50 mm
- 2** Non deve penetrare una sfera di Ø 12,5mm / Protected against the penetration of a sphere with a diameter of 12,5 mm
- 3** Non deve penetrare una sfera di Ø 2,5mm / Protected against the penetration of a sphere with a diameter of 2,5 mm
- 4** Non deve penetrare una sfera di Ø 1mm / Protected against the penetration of a sphere with a diameter of 1 mm
- 5** Protetto contro la polvere / Protected against dust  
La penetrazione di polvere non è totalmente esclusa, ma non deve penetrare in quantità tale da nuocere al buon funzionamento dell'apparecchiatura o da pregiudicarne la sicurezza. / The penetration of dust is not totally prevented, but it must not enter in sufficient quantity to interfere with the normal operation of the equipment or compromising its safety
- 6** Protetto contro la polvere / Protected against dust  
Non è ammessa la penetrazione di polvere / It is not allowed any ingress of dust

### 2<sup>a</sup> cifra | 2<sup>nd</sup> digit

#### Protezione contro i liquidi Protection against ingress of water

- 0** Nessuna protezione / No protection
- 1** Protetto contro la caduta verticale di gocce d'acqua / Protected against vertical dropping water
- 2** Protetto contro la caduta verticale di gocce d'acqua con inclinazione max dell'involucro di 15° / Protected against vertical dropping water with inclination up to 15°
- 3** Protetto contro la pioggia (angolo di caduta inferiore o uguale a 60°) / Protected against rain (fall angle lower then or equal to 60°)
- 4** Protetto contro spruzzi d'acqua / Protected against spraying water
- 5** Protetto contro getti d'acqua / Protected against water jets
- 6** Protetto contro getti d'acqua potenti (ondate) / Protected against powerful water jets
- 7** Protetto contro l'immersione temporanea (stagno all'immersione) / Protected against the effects of temporary immersion (immersion water-proof)
- 8** Protetto contro l'immersione continua (stagno all'immersione) / Protected against the effects of continuous immersion (immersion water-proof)

IP



**CP 12 - 08 R - 48S**  
**XX YY - WW K - ZZZ**

(XX)

SERIE  
SERIES

Descrizione  
Description

CS	Commutatore con morsetti IP00 Switch with IP00 terminals
CP	Commutatore con morsetti IP20 Switch with IP20 terminal

(YY) TAGLIA / SIZE

SERIE SERIES	YY	AC21A
CS	16	16
	20	25
	25	25
	32	32
	50	50
	80	75
	125	120
CP	250	200
	400	250
	630	315
CP	12	12
	16	16

(WW) SCHEMA ELETTRICO  
ELECTRICAL DIAGRAMS

Vedere pagina 36 / See page 36

(K) INSTALLAZIONE / INSTALLATION

K	Descrizione Description
B	Fissaggio fondoquadro Base mounting
R	Fissaggio retroquadro Front mounting
FC	Fissaggio su foro centrale Central mounting
E	Cassetta in plastica Plastic enclosure
EM	Cassetta in metallo Metal enclosure

(ZZZ) TIPO ATTUATORE / TYPE OF ACTUATOR

SERIE SERIES	ZZZ	Descrizione Description
CS CP	48S	Finitura standard 48x48mm / Standard actuator 48x48 mm
CS	54S	Finitura standard 54x54 mm / Standard actuator 54x54 mm
CP	64S	Finitura standard 64x64 mm / Standard actuator 64x64 mm
CS	72S	Finitura standard 72x72 mm / Standard actuator 72x72 mm
CS	105S	Finitura standard 105x105 mm / Standard actuator 105x105 mm
CS	130S	Finitura standard 130x130 mm / Standard actuator 130x130 mm
CP	64RL	Dispositivo di sicurezza con blocco lucchetti giallo/rosso 64x64 mm Safety device with locking mechanism yellow/red 64x64 mm
CP	64NL	Dispositivo di sicurezza con blocco lucchetti grigio/nero 64x64 mm Safety device with locking mechanism grey/black 64x64 mm
CS	72RL	Dispositivo di sicurezza con blocco lucchetti giallo/rosso 72x72 mm Safety device with locking mechanism yellow/red 72x72 mm
CS	72NL	Dispositivo di sicurezza con blocco lucchetti grigio/nero 72x72 mm Safety device with locking mechanism grey/black 72x72 mm
CS	105RL	Dispositivo di sicurezza con blocco lucchetti giallo/rosso 105x105 mm Safety device with locking mechanism yellow/red 105x105 mm
CS	105NL	Dispositivo di sicurezza con blocco lucchetti grigio/nero 105x105 mm Safety device with locking mechanism grey/black 105x105 mm
CS	130RL	Dispositivo di sicurezza con blocco lucchetti giallo/rosso 130x130 mm Safety device with locking mechanism yellow/red 130x130 mm
CS	130NL	Dispositivo di sicurezza con blocco lucchetti grigio/nero 130x130 mm Safety device with locking mechanism grey/black 130x130 mm
CP	00H	Solo frutto con manopola / Only body with knob
CP	47T	Manopola e targh. tonda ø 47 mm / Knob and round legend plate ø 47 mm
CP	52T	Manopola e targh. tonda ø 52 mm / Knob and round legend plate ø 52 mm
CP	59T	Manopola e targh. tonda ø 59 mm / Knob and round legend plate ø 59 mm
CS CP	22DH	Manopola fissaggio centrale ø 22 mm / Central mounting knob ø 22 mm
CS CP	22DK	Comando a chiave fissaggio centrale ø 22 mm / Key operated device with central mounting ø 22 mm
CS CP	30DH	Manopola fissaggio centrale ø 30 mm / Central mounting knob ø 30 mm
CS	45DR	Montaggio a scatto su guida DIN / Fixing on DIN rail
CP	BC	Apparecchio con dispositivo di blocco a chiave Device with key operated block
CS	00SL	App. con comando a leva laterale / Enclosed device with side lever
CS	00FN	Apparecchio CS16 in cassetta, manopola nera e coperchio grigio Enclosed CS16 device, black knob and grey cover
CS	00FR	Apparecchio CS16 in cassetta, manopola rossa e coperchio giallo Enclosed CS16 device, red knob and yellow cover

# Serie CS 16/315A | CS Series 16/315A

## Interruttori - Fissaggio retroquadro

### Front mounting switches

#### Manopola standard, protezione frontale IP40 | Standard knob IP40 front protection

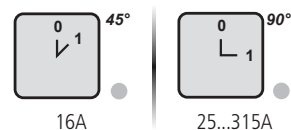

Corrente nom. Nominal current AC-21A (A)	Dimensioni Dimensions mm x mm	Unipolare 1 elemento 1 pole 1 element	Bipolare 2 elementi 2 poles 2 elements	Tripolare 3 elementi 3 poles 3 elements	Quadrupolare 4 elementi 4 poles 4 elements
16	48	CS16-01R-48S	CS16-02R-48S	CS16-03R-48S	CS16-04R-48S
25	54	CS20-01R-54S	CS20-02R-54S	CS20-03R-54S	CS20-04R-54S
25	72	CS20-01R-72S	CS20-02R-72S	CS20-03R-72S	CS20-04R-72S
25	72	CS25-01R-72S	CS25-02R-72S	CS25-03R-72S	CS25-04R-72S
32	72	CS32-01R-72S	CS32-02R-72S	CS32-03R-72S	CS32-04R-72S
50	105	CS50-01R-105S	CS50-02R-105S	CS50-03R-105S	CS50-04R-105S
75	105		CS80-02R-105S	CS80-03R-105S	CS80-04R-105S
120	130		CS125-02R-130S	CS125-03R-130S	CS125-04R-130S
200	130			CS250-03R-130S	CS250-04R-130S
250	130			CS400-03R-130S	CS400-04R-130S
315	130			CS630-03R-130S	CS630-04R-130S

#### Manopola lucchettabile, protezione frontale IP54 | Interlocked knob IP54 front protection

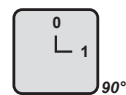

Corrente nom. Nominal current AC-21A (A)	Dimensioni Dimensions mm x mm	Tripolare 2 elementi 3 poles 2 elements	Quadrupolare 2 elementi 4 poles 2 elements	Tripolare 2 elementi 3 poles 2 elements	Quadrupolare 2 elementi 4 poles 2 elements
25	72	CS20-03R-72NL	CS20-04R-72NL	CS20-03R-72RL	CS20-04R-72RL
25	72	CS25-03R-72NL	CS25-04R-72NL	CS25-03R-72RL	CS25-04R-72RL
32	72	CS32-03R-72NL	CS32-04R-72NL	CS32-03R-72RL	CS32-04R-72RL
50	105	CS50-03R-105NL	CS50-04R-105NL	CS50-03R-105RL	CS50-04R-105RL
75	105	CS80-03R-105NL	CS80-04R-105NL	CS80-03R-105RL	CS80-04R-105RL
120	130	CS125-03R-130NL	CS125-04R-130NL	CS125-03R-130RL	CS125-04R-130RL
200	130	CS250-03R-130NL	CS250-04R-130NL	CS250-03R-130RL	CS250-04R-130RL
250	130	CS400-03R-130NL	CS400-04R-130NL	CS400-03R-130RL	CS400-04R-130RL
315	130	CS630-03R-130NL	CS630-04R-130NL	CS630-03R-130RL	CS630-04R-130RL

# Serie CS 16/315A | CS Series 16/315A

## Interruttori blocco porta - Fissaggio fondoquadro

### Base mounting interlocked switches

Manopola standard, protezione frontale IP54 | Standard knob IP54 front protection

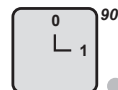

Corrente nom. Nominal current AC-21A (A)	Dimensioni Dimensions mm x mm	Tripolare 2 elementi 3 poles 2 elements	Quadripolare 2 elementi 4 poles 2 elements
25	54	CS20-03B-54S	CS20-04B-54S
25	72	CS20-03B-72S	CS20-04B-72S
25	72	CS25-03B-72S	CS25-04B-72S
32	72	CS32-03B-72S	CS32-04B-72S
50	105	CS50-03B-105S	CS50-04B-105S
75	105	CS80-03B-105S	CS80-04B-105S
120	130	CS125-03B-130S	CS125-04B-130S
200	130	CS250-03B-130S	CS250-04B-130S
250	130	CS400-03B-130S	CS400-04B-130S
315	130	CS630-03B-130S	CS630-04B-130S

Manopola lucchettabile, protezione frontale IP55 | Interlocked knob IP55 front protection

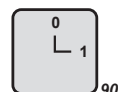

Corrente nom. Nominal current AC-21A (A)	Dimensioni Dimensions mm x mm	Tripolare 2 elementi 3 poles 2 elements	Quadripolare 2 elementi 4 poles 2 elements	Tripolare 2 elementi 3 poles 2 elements	Quadripolare 2 elementi 4 poles 2 elements
25	72	CS20-03B-72NL	CS20-04B-72NL	CS20-03B-72RL	CS20-04B-72RL
25	72	CS25-03B-72NL	CS25-04B-72NL	CS25-03B-72RL	CS25-04B-72RL
32	72	CS32-03B-72NL	CS32-04B-72NL	CS32-03B-72RL	CS32-04B-72RL
50	105	CS50-03B-105NL	CS50-04B-105NL	CS50-03B-105RL	CS50-04B-105RL
75	105	CS80-03B-105NL	CS80-04B-105NL	CS80-03B-105RL	CS80-04B-105RL
120	130	CS125-03B-130NL	CS125-04B-130NL	CS125-03B-130RL	CS125-04B-130RL
200	130	CS250-03B-130NL	CS250-04B-130NL	CS250-03B-130RL	CS250-04B-130RL
250	130	CS400-03B-130NL	CS400-04B-130NL	CS400-03B-130RL	CS400-04B-130RL
315	130	CS630-03B-130NL	CS630-04B-130NL	CS630-03B-130RL	CS630-04B-130RL

# Serie CS 16/315A | CS Series 16/315A

## Interruttori Switches

Fissaggio su foro 22 mm, protezione frontale IP66 | Hole mounting 22 mm, IP66 front protection

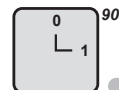

Corrente nom. Nominal current AC-21A (A)	Comando Control	Bipolare 1 elemento 2 poles 1 element	Tripolare 2 elementi 3 poles 2 elements	Quadrupolare 2 elementi 4 poles 2 elements
25	manopola / knob	CS20-02FC-22DH	CS20-03FC-22DH	CS20-04FC-22DH
25	chiave / key	CS20-02FC-22DK	CS20-03FC-22DK	CS20-04FC-22DK

## Interruttori in custodia isolante IP54 | Switches in IP54 enclosure

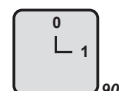

Corrente nom. Nominal current AC-21A (A)	Tripolare 2 elementi 3 poles 2 elements	Quadrupolare 2 elementi 4 poles 2 elements	Tripolare 2 elementi 3 poles 2 elements	Quadrupolare 2 elementi 4 poles 2 elements
16	CS16-03E-00FN	CS16-04E-00FN	CS16-03E-00FR <sup>1</sup>	CS16-04E-00FR <sup>1</sup>
25	CS20-03E-72S	CS20-04E-72S	CS20-03E-72RL	CS20-04E-72RL
25	CS25-03E-72S	CS25-04E-72S	CS25-03E-72RL	CS25-04E-72RL
32	CS32-03E-72S	CS32-04E-72S	CS32-03E-72RL	CS32-04E-72RL

Dimensioni / Dimensions: mm 130 x 95 H91

<sup>1</sup> Coperchio giallo e manopola rossa / Yellow cover and red knob

## Interruttori in custodia IP54, leva laterale | Switches in IP54 enclosure, side lever



Corrente nom. Nominal current AC-21A (A)	Cassetta in termoplastico Thermoplastic enclosure		Cassetta metallica Metal enclosure	
	Tripolare / 3 poles	Quadrupolare / 4 poles	Tripolare / 3 poles	Quadrupolare / 4 poles
25	CS20-03E-00SL	CS20-04E-00SL	CS20-03EM-00SL	CS20-04EM-00SL
25	CS25-03E-00SL	CS25-04E-00SL	CS25-03EM-00SL	CS25-04EM-00SL
32	CS32-03E-00SL	CS32-04E-00SL	CS32-03EM-00SL	CS32-04EM-00SL
50	CS50-03E-00SL	CS50-04E-00SL	CS50-03EM-00SL	CS50-04EM-00SL
75	CS80-03E-00SL	CS80-04E-00SL	CS80-03EM-00SL	CS80-04EM-00SL
120	—	—	CS125-03EM-00SL	CS125-04EM-00SL

# Serie CS 16/315A | CS Series 16/315A

## Commutatori di linea

### Changeover switches

Manopola standard, fissaggio retroquadro, prot. frontale IP40 | Standard knob, front mounting, IP40 front protection

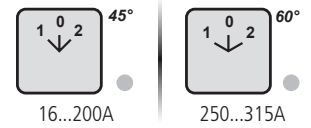

Corrente nom. Nominal current AC-21A (A)	Dimensioni Dimensions mm x mm	Unipolare 1 elemento 1 pole 1 element	Bipolare 2 elementi 2 poles 2 elements	Tripolare 3 elementi 3 poles 3 elements	Quadripolare 4 elementi 4 poles 4 elements
16	48	CS16-05R-48S	CS16-06R-48S	CS16-07R-48S	CS16-45R-48S
25	54	CS20-05R-54S	CS20-06R-54S	CS20-07R-54S	CS20-45R-54S
25	72	CS20-05R-72S	CS20-06R-72S	CS20-07R-72S	CS20-45R-72S
25	72	CS25-05R-72S	CS25-06R-72S	CS25-07R-72S	CS25-45R-72S
32	72	CS32-05R-72S	CS32-06R-72S	CS32-07R-72S	CS32-45R-72S
50	105	CS50-05R-105S	CS50-06R-105S	CS50-07R-105S	CS50-45R-105S
75	105	CS80-05R-105S	CS80-06R-105S	CS80-07R-105S	CS80-45R-105S
120	130	–	CS125-06R-130S	CS125-07R-130S	CS125-45R-130S
200	130	–	–	CS250-07R-130S	CS250-45R-130S
250	130	–	–	CS400-07R-130S	CS400-45R-130S
315	130	–	–	CS630-07R-130S	CS630-45R-130S

Manopola lucchettabile, fissaggio retroquadro, prot. frontale IP54 | Interlock knob, front mounting IP54 front protection

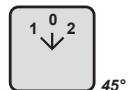

Corrente nom. Nominal current AC-21A (A)	Dimensioni Dimensions mm x mm	Tripolare 3 elementi 3 poles 3 elements	Quadripolare 4 elementi 4 poles 4 elements
25	72	CS20-07R-72NL	CS20-45R-72NL
25	72	CS25-07R-72NL	CS25-45R-72NL
32	72	CS32-07R-72NL	CS32-45R-72NL
50	105	CS50-07R-105NL	CS50-45R-105NL
75	105	CS80-07R-105NL	CS80-45R-105NL
120	130	CS125-07R-130NL	CS125-45R-130NL

# Serie CS 16/315A | CS Series 16/315A

## Commutatori di linea

### Changeover switches

Manopola lucchettabile, fissaggio fondoquadro, prot. frontale IP54 | *Interlock knob, base mounting IP54 front protection*

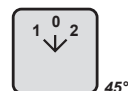

Corrente nom. Nominal current AC-21A (A)	Dimensioni Dimensions mm x mm	Tripolare 3 elementi 3 poles 3 elements	Quadripolare 4 elementi 4 poles 4 elements
25	72	CS20-07B-72NL	CS20-45B-72NL
25	72	CS25-07B-72NL	CS25-45B-72NL
32	72	CS32-07B-72NL	CS32-45B-72NL
50	105	CS50-07B-105NL	CS50-45B-105NL
75	105	CS80-07B-105NL	CS80-45B-105NL
120	130	CS125-07B-130NL	CS125-45B-130NL

Fissaggio su foro 22 mm, protezione frontale IP66 | *Hole mounting 22 mm, IP66 front protection*

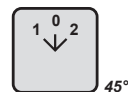

Corrente nom. Nominal current AC-21A (A)	Comando Control	Tripolare 3 elementi 3 poles 3 elements	Quadripolare 4 elementi 4 poles 4 elements
25	manopola / knob	CS20-07FC-22DH	CS20-45FC-22DH
25	chiave / key	CS20-07FC-22DK	CS20-45FC-22DK

Commutatori in cassetta IP54/55, leva laterale | *Changeover switches in IP54/55 enclosure, side lever*



Corrente nom. Nominal current AC-21A (A)	Cassetta in termoplastico IP55 IP55 thermoplastic enclosure		Cassetta metallica IP54 IP54 metal enclosure	
	Tripolare / 3 poles	Quadripolare / 4 poles	Tripolare / 3 poles	Quadripolare / 4 poles
25	CS20-07E-00SL <sup>1</sup>	CS20-45E-00SL <sup>1</sup>	CS20-07EM-00SL	CS20-45EM-00SL
25	CS25-07E-00SL <sup>1</sup>	CS25-45E-00SL <sup>1</sup>	CS25-07EM-00SL	CS25-45EM-00SL
32	CS32-07E-00SL <sup>2</sup>	CS32-45E-00SL <sup>2</sup>	CS32-07EM-00SL	CS32-45EM-00SL
50	CS50-07E-00SL <sup>2</sup>	CS50-45E-00SL <sup>2</sup>	CS50-07EM-00SL	CS50-45EM-00SL
75	CS80-07E-00SL <sup>2</sup>	CS80-45E-00SL <sup>2</sup>	CS80-07EM-00SL	CS80-45EM-00SL
120	—	—	CS125-07EM-00SL <sup>3</sup>	CS125-45EM-00SL <sup>3</sup>

Dimensioni cassetta / Enclosure dimensions: <sup>1</sup> mm 122 x 97 H79 - <sup>2</sup> mm 171 x 183 H115 - <sup>3</sup> mm 252 x 268 H172

# Serie CS 16/315A | 16/315A Series CS

## Commutatori per motori fissaggio retroquadro

### Motor switches, front mounting

Manopola standard, protezione frontale IP40 | Standard knob IP40 front protection

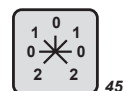
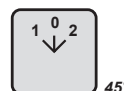
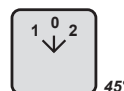

Corrente nom. Nominal current AC-21A (A)	Potenza nom. Power AC-23A (kW)	Dimensioni Dimensions mm x mm	Invertitori di marcia / Reversers			Commutatori di poli / Pole changing	
			Tripol. 3 elementi 3 poles 3 elements	Bipol. con fase ausiliaria 2 poles with auxiliary phase 3 elementi 3 elements	Bipol. con condens. 2 poles with capacitor 3 elementi 3 elements	Tripol. dahlander 3 poles dahlander 4 elementi 4 elements	Tripol. con inversione 3 poles 7 elements 7 elementi with inversion
16	5,5	48	CS16-08R-48S	-	-	-	-
25	7,5	54	CS20-08R-54S	CS20-32R-54S	CS20-37R-54S	CS20-09R-54S	CS20-11R-54S
25	7,5	72	CS20-08R-72S	CS20-32R-72S	CS20-37R-72S	CS20-09R-72S	CS20-11R-72S
25	11	72	CS25-08R-72S	CS25-32R-72S	CS25-37R-72S	CS25-09R-72S	CS25-11R-72S
32	18,5	72	CS32-08R-72S	-	-	CS32-09R-72S	-
50	22	105	CS50-08R-105S	-	-	CS50-09R-105S	-
75	30	105	CS80-08R-105S	-	-	CS50-09R-105S	-
120	45	130	CS125-08R-130S	-	-	CS125-09130S	-

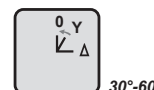
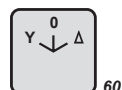
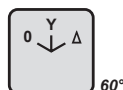

Corrente nom. Nominal current AC-21A (A)	Potenza nom. Power AC-23A (kW)	Dimensioni Dimensions mm x mm	Commutatori Y - Δ / Y - Δ switches				
			4 elementi 4 elements	4 elementi 4 elements	4 elementi 4 elements	4 elementi 4 elements	5 elementi 5 elements con invers. / with inversion
25	7,5	54	CS20-10R-54S	-	CS20-70R-54S	CS20-54R-54S	CS20-12R-54S
25	7,5	72	CS20-10R-72S	-	CS20-70R-72S	CS20-54R-72S	CS20-12R-72S
25	11	72	CS25-10R-72S	-	CS25-70R-72S	CS25-54R-72S	CS25-12R-72S
32	18,5	72	CS32-10R-72S	-	CS32-70R-72S	-	-
50	22	105	CS50-10R-105S	-	CS50-70R-105S	-	-
75	30	105	CS80-10R-105S	-	CS80-70R-105S	-	-
120	45	130	-	CS125-10R-130S	-	-	-

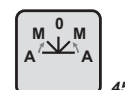

Corrente nom. Nominal current AC-21A (A)	Potenza nom. Power AC-23A (kW)	Dimensioni Dimensions mm x mm	Interruttore bipolare con fase ausiliaria 2 poles switches with aux. phase 2 elementi / 2 elements		Interruttore bipolare con fase ausiliaria e inversione 2 poles switches with aux. phase and inversion 2 elementi / 2 elements	
			20	7,5	54	CS20-29R-54S
20	7,5	72	CS20-29R-72S	CS20-30R-72S		
25	11	72	CS25-29R-72S	-		

## Commutatori per motori in cassetta IP55, leva laterale | Motor switches in IP55 enclosure, side lever

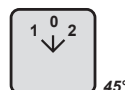
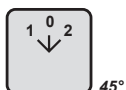

DISPONIBILI  
SU RICHIESTA  
AVAILABLE  
ON REQUEST

Corrente nom. Nominal current AC-21A (A)	Potenza nom. Power AC-23A (kW)	Invertitori di marcia tripolari 3 poles reversing switches	Commutatori di poli Dahlander Poles changing Dahlander tripolari / 3 poles	Commutatori Y - Δ Y - Δ switches
20	7,5	CS20-08E-00SL	CS20-09E-00SL	CS20-10E-00SL
25	11	CS25-08E-00SL	CS25-09E-00SL	CS25-10E-00SL
32	18,5	CS32-08E-00SL	CS32-09E-00SL	CS32-10E-00SL
50	22	CS50-08E-00SL	CS50-09E-00SL	CS50-10E-00SL
75	30	CS80-08E-00SL	CS80-09E-00SL	CS80-10E-00SL
120	40	CS125-08EM-00SL <sup>1</sup>	CS125-09EM-00SL <sup>1</sup>	CS125-10EM-00SL <sup>1 2</sup>

<sup>1</sup> Cassetta metallica IP54 / IP54 metal enclosure dimensions: mm 252 x 268 H172 - <sup>2</sup> 60°

# Serie CS 16/315A | CS Series 16/315A

## Commutatori multivie

### Multi-step switches

Manopola standard, protezione frontale IP40 | Standard knob, IP40 front protection



Corrente nom. Nominal current AC-21A (A)	Posizioni Positions	Dimensioni Dimensions mm x mm	Unipolare 1 pole	Bipolare 2 poles	Tripolare 3 poles
			2 elementi / 2 elements	3 elementi / 3 elements	5 elementi / 5 elements
16		48 ●	CS16-57R-48S	–	–
25		54 ●	CS20-57R-54S	CS20-60R-54S	CS20-61R-54S
25		72 ●	CS20-57R-72S	CS20-60R-72S	CS20-61R-72S
25		72 ●	CS25-57R-72S	CS25-60R-72S	CS25-61R-72S
32		72 ●	CS32-57R-72S	–	–
			2 elementi / 2 elements	4 elementi / 4 elements	6 elementi / 6 elements
25		54 ●	CS20-58R-54S	CS20-62R-54S	CS20-63R-54S
25		72 ●	CS20-58R-72S	CS20-62R-72S	CS20-63R-72S
25		72 ●	CS25-58R-72S	CS25-62R-72S	CS25-63R-72S
32		72 ●	CS32-58R-72S	–	–
			3 elementi / 3 elements		
25		54 ●	CS20-59R-54S		
25		72 ●	CS20-59R-72S		
25		72 ●	CS25-59R-72S		
32		72 ●	CS32-59R-72S		
			3 elementi / 3 elements	6 elementi / 6 elements	9 elementi / 9 elements
25		54 ●	CS20-64R-54S	CS20-65R-54S	CS20-66R-54S
25		72 ●	CS20-64R-72S	CS20-65R-72S	CS20-66R-72S
			4 elementi / 4 elements		
16		48 ●	CS16-67R-48S		
20		54 ●	CS20-67R-54S		
20		72 ●	CS20-67R-72S		



Corrente nom. Nominal current AC-21A (A)	Posizioni Positions	Dimensioni Dimensions mm x mm	Unipolare 1 pole	Bipolare 2 poles	Tripolare 3 poles	Quadrupolare 4 poles
			1 elemento / 1 element	2 elementi / 2 elements	3 elementi / 3 elements	4 elementi / 4 elements
25		54 ●	CS20-41R-54S	CS20-42R-54S	CS20-43R-54S	CS20-44R-54S
25		72 ●	CS20-41R-72S	CS20-42R-72S	CS20-43R-72S	CS20-44R-72S
			2 elementi / 2 elements			
25		54 ●	CS20-38R-54S			
25		72 ●	CS20-38R-72S			
			2 elementi / 2 elements	4 elementi / 4 elements	6 elementi / 6 elements	
25		54 ●	CS20-46R-54S	CS20-47R-54S	CS20-48R-54S	
25		72 ●	CS20-46R-72S	CS20-47R-72S	CS20-48R-72S	
			3 elementi / 3 elements	6 elementi / 6 elements	9 elementi / 9 elements	
25		54 ●	CS20-49R-54S	CS20-50R-54S	CS20-51R-54S	
25		72 ●	CS20-49R-72S	CS20-50R-72S	CS20-51R-72S	
			5 elementi / 5 elements			
25		54 ●	CS20-52R-54S			
25		72 ●	CS20-52R-72S			
			6 elementi / 6 elements			
25		54 ●	CS20-53R-54S			
25		72 ●	CS20-53R-72S			



# Serie CS 16/315A | CS Series 16/315A

## Commutatori voltmetrici/amperometrici

### Voltmeter/Ammeter switches

Manopola standard, fissaggio retroquadro, prot. frontale IP40 | Standard knob, front mounting, IP40 front protection

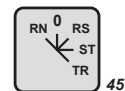
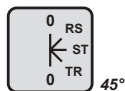
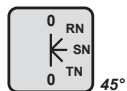

Corrente nom. Nominal current AC-21A (A)	Dimensioni Dimensions mm x mm	Voltmetrici / Voltmeter				
		3 tensioni di fase 3 phase voltages	3 tensioni concatenate 3 phase-to-phase	3 tensioni concatenate di 2 linee trifase 3 phase-to-phase of 2 three phase lines	3 tensioni concatenate 3 phase voltages 3 phase-to-phase	1 tensione di fase 3 tensioni concatenate 1 phase voltage 3 phase-to-phase
		2 elementi / 2 elements	2 elementi / 2 elements	4 elementi / 4 elements	3 elementi / 3 elements	3 elementi / 3 elements
16	48 ●	–	CS16-16R-48S	–	CS16-18R-48S	CS16-19R-48S
25	54 ●	CS20-15R-54S	CS20-16R-54S	CS20-17R-54S	CS20-18R-54S	CS20-19R-54S
25	72 ●	CS20-15R-72S	CS20-16R-72S	CS20-17R-72S	CS20-18R-72S	CS20-19R-72S
25	72 ●	CS25-15R-72S	CS25-16R-72S	–	CS25-18R-72S	–

Manopola standard, fissaggio retroquadro, prot. frontale IP40 | Standard knob, front mounting, IP40 front protection

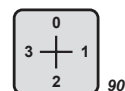
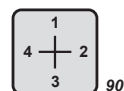
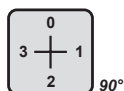

Corrente nom. Nominal current AC-21A (A)	Dimensioni Dimensions mm x mm	Amperometrici / Ammeter				
		Per misure dirette senza interr. di fase for direct measurement without break	Unipolare per 1 riduttore di corrente 1 pole for 1 current reducer	Unipolare per 3 riduttori di corrente 1 pole for 3 current reducers	Unipolare per 4 riduttori di corrente 1 pole for 4 current reducers	Bipolare per 3 riduttori di corrente 2 poles for 3 current reducers
		5 elementi / 5 elements	1 elemento / 1 element	3 elementi / 3 elements	4 elementi / 4 elements	5 elementi / 5 elements
16	48 ●	–	–	CS16-22R-48S	–	–
25	54 ●	CS20-14R-54S	CS20-20R-54S	CS20-22R-54S	CS20-23R-54S	CS20-25R-54S
25	72 ●	CS20-14R-72S	CS20-20R-72S	CS20-22R-72S	CS20-23R-72S	CS20-25R-72S
25	72 ●	CS25-14R-72S	–	CS25-22R-72S	–	CS25-25R-72S

Fissaggio su guida DIN, protezione frontale IP40 | DIN - RAIL mounting, IP40 front protection

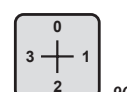
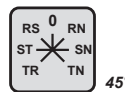
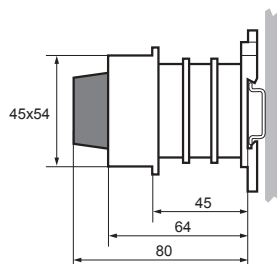

Corrente nom. Nominal current AC-21A (A)	Dimensioni Dimensions mm x mm	Voltmetrici / Voltmeter		Amperometrici / Ammeter
		3 tensioni concatenate 3 phase-to-phase	3 tensioni di fase concatenate 3 phase voltages 3 phase-to-phase	Unipolare per 3 riduttori di corrente 1 pole for 3 current reducers
25	54 x 45	CS20-16B-45DR	CS20-18B-45DR	CS20-22B-45DR

# Serie CS | CS Series

## Dimensioni di ingombro (mm) – Dime di foratura

### Dimensions (mm) – Fixing holes

#### Fissaggio retroquadro | Front mounting

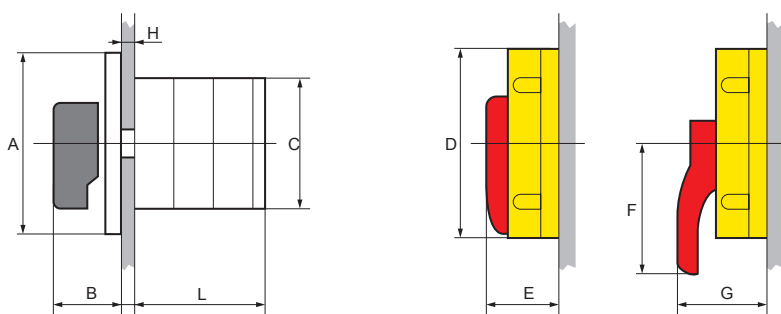

Serie Series	L per numero di elementi / L for number of elements								A (mm x mm)	B	C	D	E	F	G	H max	
	1	2	3	4	5	6	7	8									
CS16	–	32	–	54	–	–	–	–	48	23,5	ø35	–	–	–	–	–	1,5
CS20	37	50	62	75	87	100	112	125	54 o 72	28 o 32	ø47	72	38	–	–	–	1,5
CS25	35	48	60	73	85	98	110	123	72	32	ø59	–	–	–	–	–	1,5
CS32	40	58	75	93	111	129	146	164	72	32	ø59	–	–	–	–	–	1,5
CS50	51	69	87	105	123	141	159	177	105	42	ø80	105	50	–	–	–	4
CS80	60	87	114	141	168	195	222	249	105	42	ø80	105	50	–	–	–	4
CS125	83	113	143	173	203	233	263	293	130	57	118 x 102	135	–	120	70	–	4
CS250	83	113	143	173	203	233	263	293	130	57	118 x 191	135	–	120	70	–	4
CS400	113	173	233	293	353	413	473	533	130	57	118 x 180	135	–	120	70	–	4
CS630	143	233	323	413	503	593	683	773	130	57	118 x 180	135	–	120	70	–	4

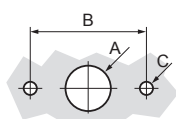

Frutti - Finiture / Elements-finishing  
CS20; CS25; CS32; CS50; CS80

Serie Series	A	B	C
CS20	9,5	32	3,2
CS25	9,5	33	3,2
CS32	9,5	33	3,2
CS50	12	46	5,3
CS80	12	46	5,3

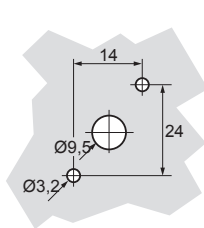

Frutti - Finiture  
Elements-finishing  
Fissaggio serie CS16  
Fixing CS16

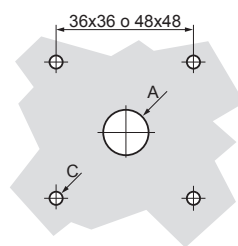

Frutti - Finiture  
Elements-finishing  
Fissaggio alternativo  
per serie CS20; CS25; CS32  
Alternative fixing  
CS20; CS25; CS32

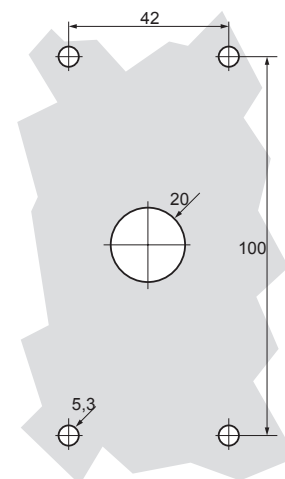

Frutti - Finiture / Elements-finishing  
CS125; CS250; CS400; CS630

#### Fissaggio su foro ø22 mm | Hole mounting ø22 mm

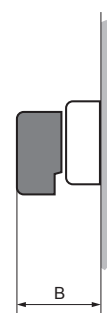
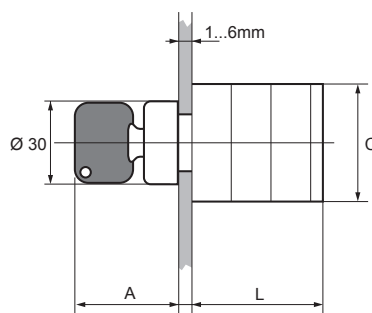
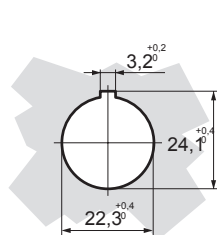

Serie Series	L per numero di elementi / L for number of elements								A	B	C
	1	2	3	4	5	6	7	8			
CS20	69	82	94	107	119	132	144	157	36	26	ø47

# Serie CS | CS Series

## Dimensioni di ingombro (mm) – Dime di foratura

### Dimensions (mm) – Fixing holes

#### Fissaggio fondoquadro | base mounting

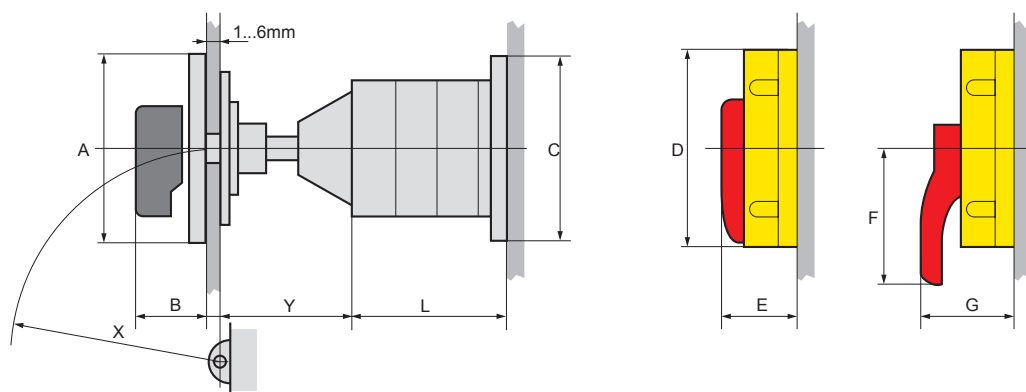

Serie Series	L per numero di elementi / L for number of elements				con Y min. if Y min.	X deve essere X must be ≥	con Y max. if Y max.	X deve essere X must be ≥
	1	2	3	4				
CS20	43	56	68	81	29	150	29	150
CS25	42	55	67	80	75	150	75	150
CS32	47	65	83	101	75	150	75	150
CS50	59	77	95	113	75	150	78	150
CS80	68	95	122	149	75	150	78	150
CS125	–	123	153	183	71,5	220	77,5	220
CS250	–	123	153	183	71,5	220	77,5	220
CS400	–	183	–	–	71,5	220	77,5	220
CS630	–	243	–	–	71,5	220	77,5	220

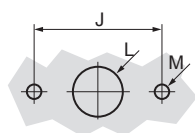

Finiture / Finishing

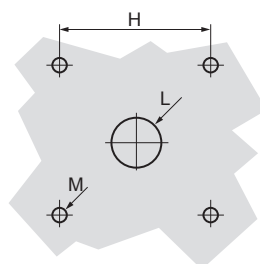

Finiture / Finishing

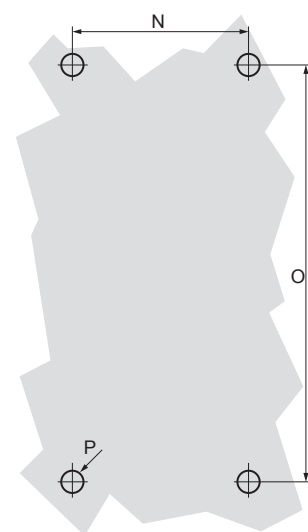

Frutti / Elements

Serie Series	A (mm x mm)	B	C	D	E	F	G	Finiture / Finishing				Frutti / Elements		
								H	J	L	M	N	O	P
CS20	50 o 72	28	51 x 51	72	38	–	–	58	32	9,5	3,2	36	36	M4
CS25	72	32	70 x 70	72	38	–	–	58	33	9,5	3,2	58	58	M4
CS32	72	32	70 x 70	72	38	–	–	58	33	9,5	3,2	58	58	M4
CS50	105	42	102 x 102	105	50	–	–	68	–	12	5,3	85	85	M5
CS80	105	42	102 x 102	105	50	–	–	68	–	12	5,3	85	85	M5
CS125	130	57	57 x 148	135	–	120	70	68	–	20	5,3	37	132	M5
CS250	130	57	57 x 148	135	–	120	70	68	–	20	5,3	37	132	M5
CS400	130	57	57 x 148	135	–	120	70	68	–	20	5,3	37	132	M5
CS630	130	57	57 x 148	135	–	120	70	68	–	20	5,3	37	132	M5

# Serie CS | CS Series

## Caratteristiche tecniche

### Technical specifications

IEC/EN 60947-3 Corrente alternata   <b>Alternative current</b>			CS16	CS20
Tensione nominale d'impiego / <i>Rated operational voltage</i> $U_e$	IEC-EN / UL-CSA	V	440	690/600
Tensione nominale d'isolamento / <i>Rated insulation voltage</i> $U_i$	IEC / UL-CSA	V	440	690/600
Tensione nominale di tenuta a impulso / <i>Rated impulse withstand voltage</i> $U_{imp}$	IEC	kV	4	6
Tensione di prova per 1 min. per verifica / <i>Dielectric test voltage for 1 min.</i> $U_i$		kV	2,5	2,5
Frequenza d'impiego / <i>Rated frequency</i>		Hz	50/60	50/60
Corrente nominale termica in aria / <i>Conventional free air thermal current</i> $I_{th}$		A	16	25
Corrente nominale termica in custodia / <i>Conventional enclosed thermal current</i> $I_{the}$		A	16	25
Potenza dissipata da un polo alla corrente termica / <i>Power loss by 1 pole at the thermal current</i> $I_{the}$		W	0,34	0,3
<b>Corrente nominale d'impiego / <i>Rated operational current</i> <math>I_e</math></b>				
<b>AC-1</b> Carichi non induttivi o debolmente induttivi / <i>Non inductive or slightly inductive loads</i>	690V	A	16 (400V)	25
<b>AC-21A</b> Manovra di carichi resistivi con sovraccarichi moderati / <i>Switching of resistive loads with slight overload</i>	690V	A	16 (400V)	25
<b>Potenza nominale d'impiego / <i>Rated power</i></b>				
<b>AC-23A</b> Manovra di motori o altri carichi altamente induttivi <i>Frequent switching of motors or other highly inductive load</i>	230V	kW	4	5,5
	400V	kW	5,5	7,5
	690V	kW	–	11
<b>AC-3</b> Motori a gabbia: avviamento, arresto a motore lanciato <i>Squirrel-cage motors: starting and stopping of running motors</i>	230V	kW	2,2	4
	400V	kW	3	5,5
	690V	kW	–	7,5
<b>AC-4</b> Motori a gabbia: avviamento, frenatura di contro corrente, manovra a impulsi <i>Squirrel-cage motors: starting, reversing, electric breaking, inching</i>	230V	kW	–	2,2
	400V	kW	–	3
	500V	kW	–	3
<b>Potere nominale di interruzione (AC-23A) / <i>Rated breaking capacity (AC-23A)</i></b>				
cos $\varphi$ 0,45 per $I_e \geq 100A$	230V	A	120	156
cos $\varphi$ 0,35 per $I_e \geq 100A$	400V	A	90,4	120
	690V	A	–	100
<b>Protezione contro il cortocircuito / <i>Short circuit protection</i></b>				
Corrente nom. di cortocircuito cond. da fusibile / <i>Fuse conditioned rated short-circuit current</i>	400/415V	kA	5	5
Corrente max. fusibile (tipo gG/gL) / <i>Max. fuse rated current (fuse type gG/gL)</i>		A	16	25
Corrente nominale di breve durata / <i>Rated short-time withstand current</i> $I_{cr}(1s)$		kA	0,32	0,5
Potere di chiusura nom. in cortocircuito (Picco) / <i>Rated short-circuit making capacity</i> $I_{cm}$		kA	–	1,5
<b>AC-15</b> carichi elettromagnetici / <i>Control of AC electromagnetic loads</i>			A300	
<b>IEC/EN 60947-3 Corrente continua   <i>Direct current</i></b>				
<b>DC-20A</b> Corrente nominale d'impiego / <i>Rated operational current</i> $I_e$		A	–	20
<b>Corrente nominale d'impiego / <i>Rated operational current</i> <math>I_e</math></b>			A	–
<b>DC-1</b> Carichi non induttivi o debolmente induttivi / <i>Non inductive or slightly inductive loads</i>		V max per polo	–	60
<b>DC-21A</b> Manovra di carichi resistivi con sovraccarichi moderati / <i>Switching of resistive loads with slight overloads</i>		V max for pole	–	60
<b>Potenza nominale d'impiego / <i>Rated power</i></b>				
<b>DC-23A</b> Comando di carichi altamente induttivi 48 V kW / <i>Control of high inductive loads series and shunt motors</i>	24V	kW	–	0,3 ①
	48V	kW	–	0,4 ①
	60V	kW	–	0,6 ①
	110V	kW	–	0,8 ①
	220V	kW	–	1,2 ①
<b>Corrente nominale d'impiego / <i>Rated operational current</i></b>				
<b>DC-13</b> Comando di elettromagneti / <i>Control of electromagnets</i>	24V	A	–	10
	48V	A	–	5
L/R = 40 ms	60V	A	–	3
	110V	A	–	1,3
	220V	A	–	0,5
	380V	A	–	0,3
	500V	A	–	0,2
<b>DC-13</b> Motori a gabbia: avviamenti, frenatura / <i>Squirrel-cage motors: starting, breaking</i>				Q300

① I valori nel cerchio corrispondono al numero di poli da collegare in serie / *The rounded values correspond to the numbers of poles to connect in series*

CS25	CS32	CS40	CS50	CS80	CS125	CS250	CS400	CS630
690/600	690/600	690/600	690/600	690/600	690/600	690/600	690/600	690/600
690/600	690/600	690/600	690/600	690/600	690/600	690/600	690/600	690/600
6	8	8	8	8	8	8	8	8
2,5	2,5	2,5	2,5	2,5	2,5	2,5	2,5	2,5
50/60	50/60	50/60	50/60	50/60	50/60	50/60	50/60	50/60
25	32	40	50	80	125	250	400	630
25	32	40	50	75	120	200	315	500
0,6	0,8	0,8	1,5	2,8	5,3	10	13,6	25,5
25	32	40	50	75	120	200	250	315
25	32	40	50	75	120	200	250	315
7,5	11	11	15	18,5	30	37	–	–
11	18,5	18,5	22	30	45	55	–	–
15	22	22	30	37	55	75	–	–
5,5	7,5	7,5	11	15	22	30	–	–
7,5	15	15	18,5	22	30	37	–	–
11	18,5	18,5	22	30	37	45	–	–
2,2	3	3	7,5	11	15	18,5	–	–
4	4	4	11	15	22	30	–	–
4	5,5	5,5	15	18,5	30	37	–	–
204	296	296	400	484	780	936	–	–
172	280	280	336	544	656	804	–	–
136	196	196	260	316	456	616	–	–
5	5	5	5	5	6	8	12	15
25	35	35	50	63	100	160	250	315
0,5	0,64	0,64	1	1,5	2,4	4	5	6,5
1,5	2	2	2,5	3	5	7	10	15

25	32	40	50	75	120	200	–	–
16	25	25	40	63	100	200	–	–
60	60	60	60	60	48	42	–	–
60	60	60	60	60	48	42	–	–
0,3 ①	0,3 ①	0,3 ①	0,7 ①	1 ①	–	–	–	–
0,5 ②	0,5 ②	0,5 ②	1,4 ②	2 ②	–	–	–	–
1 ③	1 ③	1 ③	2 ③	2,7 ③	–	–	–	–
2 ④	2 ④	2 ④	3 ④	4 ④	–	–	–	–
2,2 ⑤	2,2 ⑤	2,2 ⑤	6 ⑤	8 ⑤	–	–	–	–
14	16	16	–	–	–	–	–	–
7	8	8	–	–	–	–	–	–
4,2	4,8	4,8	–	–	–	–	–	–
1,8	2	2	–	–	–	–	–	–
0,5	0,6	0,6	–	–	–	–	–	–
0,4	0,4	0,4	–	–	–	–	–	–
0,3	0,3	0,3	–	–	–	–	–	–

# Serie CS | CS Series

## Caratteristiche tecniche

### Technical specifications

UL-CSA			CS16	CS20
<b>Usi generali</b> 1 fase/2 poli, 3 fasi/2 poli / <b>General use</b> 1 phase/2 poles, 3 phases/3 poles				
Corrente nominale / <i>Nominal current</i>	600V	A	–	20
Heavy Pilot Duty (AC)	Codice designazione / Code designation		–	A 600
Standard Duty (DC)	Codice designazione / Code designation		–	P 600
<b>Potenza nominale d'impiego / Rated operational power</b>				
Carico motore standard / <i>Standard motor charge</i>				
DOL - Rating	120V	HP	–	1,5
1 fase 2 poli / <i>1 phase 2 poles</i>	240V	HP	–	3
	480V	HP	–	5
	600V	HP	–	5
3 fasi 3 poli / <i>3 phases 3 poles</i>	120V	HP	–	2
	240V	HP	–	5
	480V	HP	–	10
	600V	HP	–	10

<b>Dati ambientali / Ambient data</b>				
<b>Temperatura ambiente / Ambient temperature</b>			Esercizio / <i>Operating</i>	-25°C...+60°C
			Stoccaggio / <i>Storage</i>	-40°C...+80°C

<b>Dati meccanici / Mechanical data</b>					
<b>Grado di protezione secondo IEC/EN 60529 / Protection degree according to IEC/EN 60529</b>					
Finiture / <i>Finishing</i>			IP40	IP40...IP65	
Frutti / <i>Elements</i>			IP00	IP00	
<b>Durata di vita meccanica / Duration of mechanical life</b>	Mio. di manovre / <i>Million operations</i>		1	2	
<b>Sezioni massime collegabili / Maximum sections connectable</b>					
Carico massimo sezione conduttori secondo IEC/EN 60947-1 / <i>Maximum rating section conductors according to IEC/EN 60947-1</i>			A2	A3	
Flessibile / <i>Flexible</i>	mm <sup>2</sup>		0,75/2,5	1/2,5	
Rigido - cordato / <i>Rigid - stranded</i>	mm <sup>2</sup>		0,75/2,5	1/4	
Sezioni massimi collegabili secondo UL/CSA / <i>Max cross sections according to UL/CSA solid stranded</i>			AWG	14/14	10/12
<b>Morsetti / Terminals</b>					
			Tipo / <i>Type</i>	Vite / <i>Screw</i>	
			Filettatura / <i>Thread</i>	M3,5	M3,5
			Grandezza cacciavite lama-croce / <i>Screw driver size blade-cross</i>	2/1	3/2
			Copia di serraggio (Nm) / <i>Torque (Nm)</i>	0,6	1,2

<b>Omologazioni / Approvals</b>				
Marcatura CE / <i>CE marking</i>			Si / Yes	Si / Yes
UR (USA)				Si / Yes
cURus				*

\* Omologazioni in corso / *Pending approvals*

CS25	CS32	CS50	CS80	CS125	CS250	CS400	CS630
16	25 32	50	63	115	200	250 (315A a 480V)	315
–	–	3	5	7,5	10	–	–
3	5 5	7,5	10	15	20	–	–
6	10 10	15	20	30	40	–	–
7,5	12 12	20	25	35	50	–	–
–	–	7,5	10	15	25	–	–
6	10	15	20	30	50	–	–
12	20	30	40	60	75	–	–
15	26	40	50	75	100	–	–

Esercizio / Operating -25°C...+60°C

Stoccaggio / Storage -40°C...+80°C

IP40...IP55	IP40...IP55	IP65	IP65	IP65	IP65	IP65	IP65
IP00	IP00	IP00	IP00	IP00	IP00	IP00	IP00
1,5	1,5	1	1	1	1	0,5	0,5
A3	A5	A5	A5	B9	–	–	–
1/2,5	2,5/6	2,5/6	2,5/16	1,5/35	–	–	–
1/4	2,5/10	2,5/10	2,5/25	1,5/50	–	–	–
10/12	8/10	8/10	4/6	1/2	–	–	–
Vite / Screw	Vite / Screw	Vite / Screw	Vite / Screw	Vite / Screw	Esagono incas. / Hexagon	Esagono incas. / Hexagon	Esagono incas. / Hexagon
M4	M5	M5	2xM4	2xM6	M10	M12	M14
3/2	3/2	3/2	3/2	4/–	Esagono 8 mm / Hexagon	Esagono 10 mm / Hexagon	Esagono 12 mm / Hexagon
1,2	2	2	1,2	2	10	14	19

Si / Yes	Si / Yes	Si / Yes	Si / Yes	Si / Yes	Si / Yes	Si / Yes	Si / Yes
*	*	*	*	*	*	*	*
*	Si / Yes	Si / Yes	Si / Yes	Si / Yes	Si / Yes	Si / Yes	Si / Yes

## Serie CP 12/16A | CP Series 12/16A

### Interruttori con morsetti IP20, fissaggio retroquadro Switches with IP20 terminals, front mounting

#### Manopola standard, protezione frontale IP54 | Standard knob, IP54 front protection

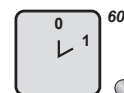

Corrente nom. Nominal current AC-21A (A)	Dimensioni Dimensions mm x mm	Unipolare 1 elemento 1 pole 1 element	Bipolare 1 elemento 2 poles 1 element	Tripolare 2 elementi 3 poles 2 elements	Quadripolare 2 elementi 4 poles 2 elements
12	48	CP12-01R-48S	CP12-02R-48S	CP12-03R-48S	CP12-04R-48S
12	64	CP12-01R-64S	CP12-02R-64S	CP12-03R-64S	CP12-04R-64S
16	48	CP16-01R-48S	CP16-02R-48S	CP16-03R-48S	CP16-04R-48S
16	64	CP16-01R-64S	CP16-02R-64S	CP16-03R-64S	CP16-04R-64S

#### Manopola standard con e senza mostrina tonda, prot. frontale IP40 | Standard knob with and without round plate, IP40 front prot.

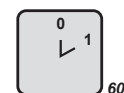

Corrente nom. Nominal current AC-21A (A)	Ø mostrina Plate Ø mm	Unipolare 1 elemento 1 pole 1 element	Bipolare 1 elemento 2 poles 1 element	Tripolare 2 elementi 3 poles 2 elements	Quadripolare 2 elementi 4 poles 2 elements
12	–	CP12-01R-00H	CP12-02R-00H	CP12-03R-00H	CP12-04R-00H
12	47	CP12-01R-47T	CP12-02R-47T	CP12-03R-47T	CP12-04R-47T
12	52	CP12-01R-52T	CP12-02R-52T	CP12-03R-52T	CP12-04R-52T
12	57	CP12-01R-59T	CP12-02R-59T	CP12-03R-59T	CP12-04R-59T
16	–	CP16-01R-00H	CP16-02R-00H	CP16-03R-00H	CP16-04R-00H
16	47	CP16-01R-47T	CP16-02R-47T	CP16-03R-47T	CP16-04R-47T
16	52	CP16-01R-52T	CP16-02R-52T	CP16-03R-52T	CP16-04R-52T
16	57	CP16-01R-59T	CP16-02R-59T	CP16-03R-59T	CP16-04R-59T

#### Manopola lucchettabile, protezione frontale IP54 | Interlock knob, IP54 front protection

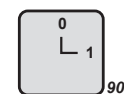

Corrente nom. Nominal current AC-21A (A)	Dimensioni Dimensions mm x mm	Unipolare 1 elemento 1 pole 1 element	Bipolare 1 elemento 2 poles 1 element	Tripolare 2 elementi 3 poles 2 elements	Quadripolare 2 elementi 4 poles 2 elements
12	64	CP12-01R-64RL	CP12-02R-64RL	CP12-03R-64RL	CP12-04R-64RL
12	64	CP12-01R-64NL	CP12-02R-64NL	CP12-03R-64NL	CP12-04R-64NL
16	64	CP16-01R-64RL	CP16-02R-64RL	CP16-03R-64RL	CP16-04R-64RL
16	64	CP16-01R-64NL	CP16-02R-64NL	CP16-03R-64NL	CP16-04R-64NL



# Serie CP 12/16A | CP Series 12/16A

## Interruttori con morsetti IP20, fissaggio su foro 22mm

### Switches with IP20 terminals, hole 22mm mounting

Fissaggio su foro 22mm, protezione frontale IP54 | Hole mounting 22mm, IP54 front protection

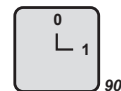

Corrente nom. Nominal current AC-21A (A)	Dimensioni Dimensions mm x mm	Manopola Knob	Unipolare 1 elemento 1 pole 1 element	Bipolare 1 elemento 2 poles 1 element	Tripolare 2 elementi 3 poles 2 elements	Quadrupolare 2 elementi 4 poles 2 elements
12	64	●	CP12-01FC-64RL	CP12-02FC-64RL	CP12-03FC-64RL	CP12-04FC-64RL
12	64	●	CP12-01FC-64NL	CP12-02FC-64NL	CP12-03FC-64NL	CP12-04FC-64NL
12	48	○	CP12-01FC-48S	CP12-02FC-48S	CP12-03FC-48S	CP12-04FC-48S
12	-		CP12-01FC-22DH	CP12-02FC-22DH	CP12-03FC-22DH	CP12-04FC-22DH
12	-	⌚	CP12-01FC-22DK	CP12-02FC-22DK	CP12-03FC-22DK	CP12-04FC-22DK
16	64	●	CP16-01FC-64RL	CP16-02FC-64RL	CP16-03FC-64RL	CP16-04FC-64RL
16	64	●	CP16-01FC-64NL	CP16-02FC-64NL	CP16-03FC-64NL	CP16-04FC-64NL
16	48	○	CP16-01FC-48S	CP16-02FC-48S	CP16-03FC-48S	CP16-04FC-48S
16	-		CP16-01FC-22DH	CP16-02FC-22DH	CP16-03FC-22DH	CP16-04FC-22DH
16	-	⌚	CP16-01FC-22DK	CP16-02FC-22DK	CP16-03FC-22DK	CP16-04FC-22DK

## Serie CP 12/16A | CP Series 12/16A

### Commutatori di linea con morsetti IP20, fissaggio retroquadro Changeover switches with IP20 terminals, front mounting

Manopola standard, protezione frontale IP54 | Standard knob, IP54 front protection

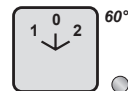

Corrente nom. Nominal current AC-21A (A)	Dimensioni Dimensions mm x mm	Unipolare 1 elemento 1 pole 1 element	Bipolare 2 elementi 2 poles 2 elements	Tripolare 3 elementi 3 poles 3 elements	Quadripolare 4 elementi 4 poles 4 elements
12	48	CP12-05R-48S	CP12-06R-48S	CP12-07R-48S	CP12-45R-48S
12	64	CP12-05R-64S	CP12-06R-64S	CP12-07R-64S	CP12-45R-64S
16	48	CP16-05R-48S	CP16-06R-48S	CP16-07R-48S	CP16-45R-48S
16	64	CP16-05R-64S	CP16-06R-64S	CP16-07R-64S	CP16-45R-64S

Manopola standard con e senza mostrina tonda, prot. frontale IP40 | Standard knob with and without round plate, IP40 front prot.

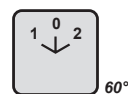

Corrente nom. Nominal current AC-21A (A)	Ø mostrina Plate Ø mm	Unipolare 1 elemento 1 pole 1 element	Bipolare 1 elemento 2 poles 1 element	Tripolare 2 elementi 3 poles 2 elements	Quadripolare 2 elementi 4 poles 2 elements
12	–	CP12-05R-00H	CP12-06R-00H	CP12-07R-00H	CP12-45R-00H
12	47	CP12-05R-47T	CP12-06R-47T	CP12-07R-47T	CP12-45R-47T
12	52	CP12-05R-52T	CP12-06R-52T	CP12-07R-52T	CP12-45R-52T
12	57	CP12-05R-59T	CP12-06R-59T	CP12-07R-59T	CP12-45R-59T
16	–	CP16-05R-00H	CP16-06R-00H	CP16-07R-00H	CP16-45R-00H
16	47	CP16-05R-47T	CP16-06R-47T	CP16-07R-47T	CP16-45R-47T
16	52	CP16-05R-52T	CP16-06R-52T	CP16-07R-52T	CP16-45R-52T
16	57	CP16-05R-59T	CP16-06R-59T	CP16-07R-59T	CP16-45R-59T

Manopola lucchettabile, protezione frontale IP54 | Interlock knob, IP54 front protection

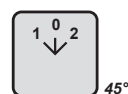

Corrente nom. Nominal current AC-21A (A)	Dimensioni Dimensions mm x mm	Tripolare 3 elementi 3 poles 3 elements	Quadripolare 4 elementi 4 poles elements
12	64 ●	CP12-07R-64NL	CP12-45R-64NL
16	64 ●	CP16-07R-64NL	CP16-45R-64NL

## Serie CP 12/16A | CP Series 12/16A

### Commutatori di linea con morsetti IP20, fissaggio su foro 22mm Changeover switches with IP20 terminals, hole 22mm mounting

Fissaggio su foro 22mm, protezione frontale IP54 | Hole mounting 22mm, IP54 front protection

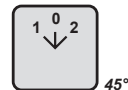

Corrente nom. Nominal current AC-21A (A)	Dimensioni Dimensions mm x mm	Manopola Knob	Unipolare 1 elemento 1 pole 1 element	Bipolare 2 elementi 2 poles 2 elements	Tripolare 3 elementi 3 poles 3 elements	Quadrupolare 4 elementi 4 poles 4 elements
12	64 ●	lucchettabile / interlock	CP12-05FC-64NL	CP12-06FC-64NL	CP12-07FC-64NL	CP12-45FC-64NL
12	48 ○	standard / standard	CP12-05FC-48S	CP12-06FC-48S	CP12-07FC-48S	CP12-45FC-48S
12	–	corta / short	CP12-05FC-22DH	CP12-06FC-22DH	CP12-07FC-22DH	CP12-45FC-22DH
12	–	chiave / key ⤵	CP12-05FC-22DK	CP12-06FC-22DK	CP12-07FC-22DK	CP12-45FC-22DK
16	64 ●	lucchettabile / interlock	CP16-05FC-64NL	CP16-06FC-64NL	CP16-07FC-64NL	CP16-45FC-64NL
16	48 ○	standard / standard	CP16-05FC-48S	CP16-06FC-48S	CP16-07FC-48S	CP16-45FC-48S
16	–	corta / short	CP16-05FC-22DH	CP16-06FC-22DH	CP16-07FC-22DH	CP16-45FC-22DH
16	–	chiave / key ⤵	CP16-05FC-22DK	CP16-06FC-22DK	CP16-07FC-22DK	CP16-45FC-22DK

# Serie CP 12/16A | CP Series 12/16A

## Commutatori per motori con morsetti IP20, fissaggio retroquadro, su foro 22mm Motor switches with IP20 terminals, front or hole 22mm mounting

Manopola standard, protezione frontale IP54 | Standard knob, IP54 front protection



60°



45°



60°

Corrente nom. Nominal current AC-21A (A)	Potenza nom. Power AC-23A (kW)	Dimensioni Dimensions mm x mm	Invertitori di marcia / Reversing switches		Commutatori di poli / Pole changing switches
			Tripolare 3 elementi 3 poles 3 elements	Bipolare con fase ausiliaria 2 poles with aux. phase 3 elementi / 3 elements	Tripolare Dahlander 3 poles Dahlander 4 elementi / 4 elements
12	5,5	48	CP12-08R-48S	CP12-32R-48S	CP12-09R-48S
12	5,5	64	CP12-08R-64S	CP12-32R-64S	CP12-09R-64S
16	7,5	48	CP16-08R-48S	CP16-32R-48S	CP16-09R-48S
16	7,5	64	CP16-08R-64S	CP16-32R-64S	CP16-09R-64S



60°



45°

Corrente nom. Nominal current AC-21A (A)	Potenza nom. Power AC-23A (kW)	Dimensioni Dimensions mm x mm	Commutatori Y - Δ / Y - Δ switches	Interruttore bipolare con fase ausiliaria
			4 elementi / 4 elements	2 poles switch with aux. phase 2 elementi / 2 elements
12	5,5	48	CP12-10R-48S	CP12-29R-48S
12	5,5	64	CP12-10R-64S	CP12-29R-64S
16	7,5	48	CP16-10R-48S	CP16-29R-48S
16	7,5	64	CP16-10R-64S	CP16-29R-64S

## Fissaggio su foro 22mm, protezione frontale IP54/66 | Hole mounting 22mm, IP54/66 front protection



60°



45°



60°

Corrente nom. Nominal current AC-21A (A)	Potenza nom. Power AC-23A (kW)	Dimensioni Dimensions mm x mm	Invertitori di marcia / Reversing switches		Commutatori di poli / Pole changing switches
			Tripolare 3 elementi 3 poles 3 elements	Bipolare con fase ausiliaria 2 poles with aux. phase 3 elementi / 3 elements	Tripolare Dahlander 3 poles Dahlander 4 elementi / 4 elements
12	5,5	48	CP12-08FC-48S <sup>1</sup>	CP12-32FC-48S <sup>1</sup>	CP12-09FC-48S <sup>1</sup>
12	5,5	-	CP12-08FC-22DH <sup>2</sup>	CP12-32FC-22DH <sup>2</sup>	CP12-09FC-22DH <sup>2</sup>
16	7,5	48	CP16-08FC-48S <sup>1</sup>	CP16-32FC-48S <sup>1</sup>	CP16-09FC-48S <sup>1</sup>
16	7,5	-	CP16-08FC-22DH <sup>2</sup>	CP16-32FC-22DH <sup>2</sup>	CP16-09FC-22DH <sup>2</sup>

<sup>1</sup> Protezione frontale IP54 / IP54 front protection - <sup>2</sup> Protezione frontale IP66 / IP66 front protection



60°



45°

Corrente nom. Nominal current AC-21A (A)	Potenza nom. Power AC-23A (kW)	Dimensioni Dimensions mm x mm	Commutatori Y - Δ / Y - Δ switches	Interruttore bipolare con fase ausiliaria
			4 elementi / 4 elements	2 poles switch with aux. phase 2 elementi / 2 elements
12	5,5	48	CP12-10FC-48S <sup>1</sup>	CP12-29FC-48S <sup>1</sup>
12	5,5	-	CP12-10FC-22DH <sup>2</sup>	CP12-29FC-22DH <sup>2</sup>
16	7,5	48	CP16-10FC-48S <sup>1</sup>	CP16-29FC-48S <sup>1</sup>
16	7,5	-	CP16-10FC-22DH <sup>2</sup>	CP16-29FC-22DH <sup>2</sup>

<sup>1</sup> Protezione frontale IP54 / IP54 front protection - <sup>2</sup> Protezione frontale IP66 / IP66 front protection

## Serie CP 12/16A | CP Series 12/16A

Commutatori voltmetrici/amperometrici mors. IP20, fissaggio retroquadro, su foro 22mm  
 Voltmeter/Ammeter switches with IP20 terminals, front or hole 22mm mounting

Manopola standard, protezione frontale IP54 | Standard knob, IP54 front protection

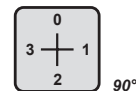
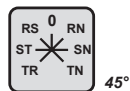

Corrente nom. Nominal current AC-21A (A)	Dimensioni Dimensions mm x mm	Voltmetrici / Voltmeter			Amperometrici / Ammeter Unipolare per 3 riduttori di corrente 1 pole for 3 current reducers 3 elementi / 3 elements
		3 tensioni concatenate 3 phase-to-phase 2 elementi / 2 elements	3 tensioni di fase 3 tensioni concatenate 3 phase voltages 3 phase-to-phase 3 elementi / 3 elements	3 tensioni concatenate 3 phase-to-phase 3 elementi / 3 elements	
12	48	CP12-16R-48S	CP12-18R-48S	CP12-22R-48S	
12	64	CP12-16R-64S	CP12-18R-64S	CP12-22R-64S	
16	48	CP16-16R-48S	CP16-18R-48S	CP16-22R-48S	
16	64	CP16-16R-64S	CP16-18R-64S	CP16-22R-64S	

Fissaggio su foro 22mm, protezione frontale IP54/66 | Hole mounting 22mm, IP54/66 front protection

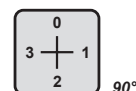

Corrente nom. Nominal current AC-21A (A)	Dimensioni Dimensions mm x mm	Voltmetrici / Voltmeter			Amperometrici / Ammeter Unipolare per 3 riduttori di corrente 1 pole for 3 current reducers 3 elementi / 3 elements
		3 tensioni concatenate 3 phase-to-phase 2 elementi / 2 elements	3 tensioni di fase 3 tensioni concatenate 3 phase voltages 3 phase-to-phase 3 elementi / 3 elements	3 tensioni concatenate 3 phase-to-phase 3 elementi / 3 elements	
12	48	CP12-16FC-48S <sup>1</sup>	CP12-18FC-48S <sup>1</sup>	CP12-22FC-48S <sup>1</sup>	
12	-	CP12-16FC-22DH <sup>2</sup>	CP12-18FC-22DH <sup>2</sup>	CP12-22FC-22DH <sup>2</sup>	
16	48	CP16-16FC-48S <sup>1</sup>	CP16-18FC-48S <sup>1</sup>	CP16-22FC-48S <sup>1</sup>	
16	-	CP16-16FC-22DH <sup>2</sup>	CP16-18FC-22DH <sup>2</sup>	CP16-22FC-22DH <sup>2</sup>	

<sup>1</sup> Protezione frontale IP54 / IP54 front protection - <sup>2</sup> Protezione frontale IP66 / IP66 front protection

# Serie CP 12/16A | CP Series 12/16A

## Dimensioni di ingombro (mm)

### Dimensions (mm)

Serie CP 12/16A | CP Series 12/16A

□□□□□□□□□□48□ □ 64□

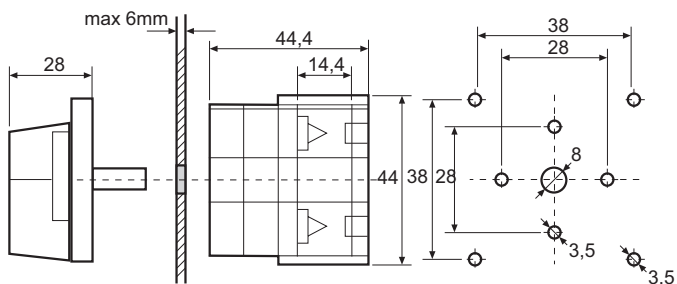

□□□□□□□□□□64□ □ 64□

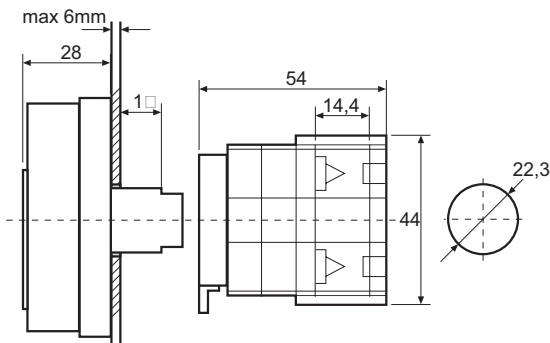

□□□□□□□□□□□□ □4□ □52□ □5□ □

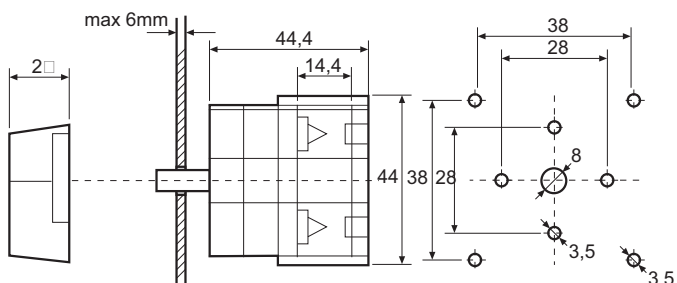

□□□□□□□□□□48□

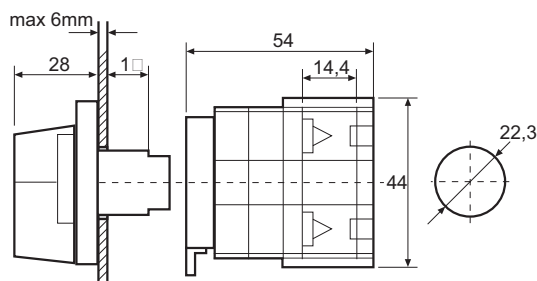

□□□□□□□□□□64□ □ 64□ □

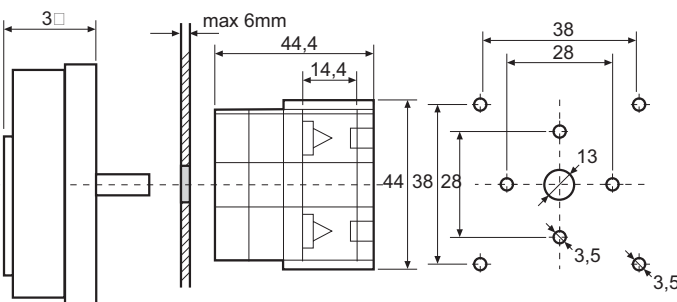

□□□□□□□□□□22□ □

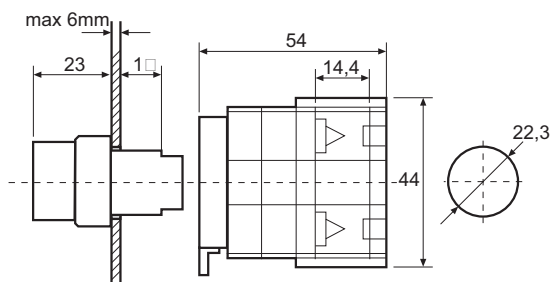

□□□□□□□□□□22□ □

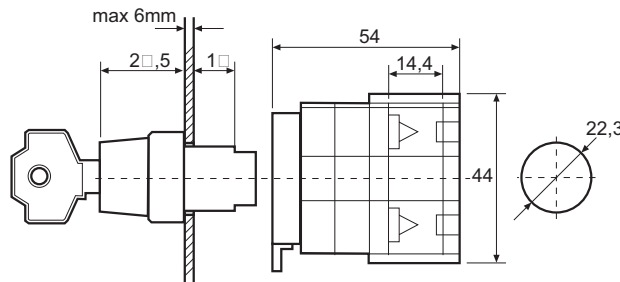

# Serie CP | CP Series

## Caratteristiche tecniche

### Technical specifications

#### Serie CP 12/16A | CP Series 12/16A

Serie-Taglia / Size-Series	CP12	CP16
$I_{th}$	12	16
<b>AC21</b>	Manovra di carichi resistivi con sovraccarichi di modesta entità / <i>Switching of resistive loads with light overloads</i>	
$U_e$ (V)	690	690
$I_e$ (A)	12	16
<b>AC2</b>	Motori ad anelli: avviamento disinserzione / <i>Slip-ring motors: switching on and switching off</i>	
220...240V - 3ph (kW)	2,5	5,5
380...440V - 3ph (kW)	4,3	9,5
500V - 3ph (kW)	4,3	9,5
<b>AC23</b>	Manovra di motori o altri carichi altamente induttivi / <i>Switching of motor loads or other highly inductive loads</i>	
220...240V - 1ph (kW)	1,3	3,2
220...240V - 3ph (kW)	3,9	5,5
380...440V - 3ph (kW)	5,5	10,5
500V - 3ph (kW)	5,5	10,5
<b>AC3</b>	Motori a gabbia: avviamento, arresto di motore durante la rotazione / <i>Squirrel-cage motors: starting, switches off motors during running time</i>	
220...240V - 1ph (kW)	1,6	3,0
220...240V - 3ph (kW)	3,0	5,5
380...440V - 3ph (kW)	4,2	7,9
500V - 3ph (kW)	4,2	10,5
<b>AC4</b>	Motori a gabbia: avviamento, frenatura di contro corrente, manovra a impulsi / <i>Squirrel-cage motors: starting, plugging, inching</i>	
220...240V - 1ph (kW)	0,35	0,8
220...240V - 3ph (kW)	2,1	2,2
380...440V - 3ph (kW)	2,2	3,9
500V - 3ph (kW)	2,2	4,1
<b>AC15</b>	Comando di carichi elettromagnetici in corrente alternata / <i>Switching of alternate current electromagnetic loads</i>	
230V (A)	–	6,2
400V (A)	–	4,3
500V (A)	–	3,3

Serie-Taglia / Size-Series	CP12	CP16
Corrente nominale di breve durata ammissibile (Isg.) / <i>Admittable short-time rated current</i>	A 500	500
Sezioni minime/massime collegabili (mm <sup>2</sup> ) / <i>Minimum / Maximum connecting cables sections</i>	6	6
Viti morsetti / <i>Terminals screws</i>	M3	M3
Durata meccanica / <i>Mechanical life</i>	10 <sup>6</sup>	10 <sup>6</sup>
Durata elettrica / <i>Electrical life</i>	5.10 <sup>5</sup>	5.10 <sup>5</sup>
Carico ammissibile in servizio intermittente / <i>Load capacity with discontinuous load</i>	Duty cycle: 60/40/25 % = 1,3/1,6/2,0 x I <sub>th</sub>	
Temperatura ambiente di utilizzo / <i>Operating ambient temperature</i>	°C A giorno / <i>free air</i> +60...-25 in cassetta / <i>in enclosure</i> +40...-25	
Norme di riferimento / <i>Reference standards</i>	IEC/EN 60947-3	IEC/EN 60947-3
Approvazioni in corso / <i>Pending homologations</i>	UL, CSA, IMQ	

# Serie CS-CP | CS-CP Series

## Accessori

## Accessories

Descrizione / Description	Serie / Series	Codice / Code	Descrizione / Description	Serie / Series	Codice / Code
 <p>Manopola / Knob L 40 mm nera / black L 40 mm rossa / red L 50 mm nera / black L 70 mm nera / black L 140 mm nera / black</p>	CS20 CS20 CS20/25/32 CS50/80 CS125/250	ACM-1392N ACM-1392R ACM-1527N ACM-1538N ACM-991N	 <p>Manopola / Knob ø30 mm nera / black ø30 mm rossa / red ø37 mm nera / black ø41 mm nera / black ø41 mm IP65 nera / black</p>	CS20/25/32 CS20/25/32 CS20/25/32 CS20/25/32 CS20/25/32	ACM-2536N ACM-2057R ACM-2057N ACM-3587N ACM-2854N
 <p>Manopola lucchettabile / Padlockable knob 72x72 mm giallo-rossa / yellow-red 105x105 mm giallo-rossa / yellow-red</p>	CS20/25/32 CS50/80	ACF-2391RL ACF-2392RL	 <p>Manopola lucchettabile grigio-nera / Padlockable knob grey-black 72x72 mm 0-1 72x72 mm 1-0-2 105x105 mm 1-0-2</p>	CS20/25/32 CS20/25/32 CS50/80	ACT-3818NL ACF-2393NL ACF-2394NL
 <p>Leva nera / Black lever Leva arancione / Orange lever Leva arancione / Orange lever Leva arancione / Orange lever</p>	CS20/25/32 CS20/25/32 CS50/80 CS125..630	ACL-1529N ACL-1529L ACL-1540L ACL-997L	 <p>Targhetta gialla man. rossa per interruttori Yellow legend plate red knob for switches 72 mm 54 mm 105 mm</p>	CS20/25/32 CS20 CS50/80	ACT-2397YR ACT-2396YR ACT-2398YR
 <p>Finitura (senza manopola) / actuator (without knob) 54x54 mm targhetta neutra 54x54 mm Neutral plate 72x72 mm targhetta neutra 72x72 mm Neutral plate</p>	CS20/25/32 CS20/25/32	ACF-3455SM ACF-3456SM	 <p>Finitura protetta 70x70 mm (completa di targhetta 0-1 ø57) Protected actuator 70x70 mm (complete with legend plate 0-1 ø57)</p>	CS20/25/32	ACF-2433SM
 <p>Set di guarnizioni IP54 per finiture standard IP40 IP54 gasket set for standard IP40 actuators</p>	CS20 CS20/25/32 CS50/80	ACG-1683 ACG-1590 ACG-1619	 <p>Comando a chiave per fissaggio su foro ø22 mm Key operated for fixing on ø22 mm hole</p>	CS20	ACF-2389N
 <p>Comando a manopola per fissaggio su foro ø22 mm Knob control for fixing on ø22 mm hole</p>	CS20	ACF-2390N	 <p>Anello di riduzione da ø30 mm a ø22 mm Reducing ring from ø30mm to ø22mm</p>	CS20	ACR-2326
 <p>Supporto per fissaggio posteriore Support for base mounting ① fino a 6 elementi / up to 6 elements ② oltre 6 elementi / more than 6 elements</p>	CS20 CS25/30 CS50/80 CS125/250 CS125/250 CS400/630	ACS-1720 ACS-1722 ACS-1724 ACS-1462 ACS-1474 ACS-1474	 <p>Staffe di prolunga per fissaggio posteriore Extension shaft for base fixing Lunghezza / Length: 35..171 mm</p>	CS20..80	ACS-1761
 <p>Piastra per aggancio su guida DIN Plate for DIN rail mounting</p>	CS20	ACD-2535	 <p>Piastra adattatrice per 4 fori di fissaggio Plate adapter for 4 fixing holes 68x68mm o 86x86mm 68x68 mm o 104x104 mm</p>	CS50/80 CS125..630	ACS-3516 ACS-3517
 <p>Adattatore Faston 6,3 mm per morsetti con viti M3,5 Faston adapter 6,3 mm for terminals with M3,5 screws</p>	CS20	ACC-417	 <p>Dispositivo per trasformazione in blocco porta delle versioni retroquadro Device for changing from rear mounting type to interlock type</p>	CS25/32 CS50/80	ACF-2065SM ACF-2066SM

DISPONIBILE  
SU RICHIESTA  
AVAILABLE  
ON REQUEST



**Descrizione / Description**

**Serie / Series Codice / Code**

Protezione morsetti interruttori 3-4 poli / *Terminals protection 3-4 poles switches*



retroquadro <i>front mounting</i>	CS20/25/32	ACC-25RC4
	CS50	ACC-50RC4
	CS80	ACC-80RC4
	CS125	ACC-125RC4
fondoquadro <i>base mounting</i>	CS20/25/32	ACC-25BC4
	CS50	ACC-50BC4
	CS80	ACC-80BC4
	CS125	ACC-125BC4

Protezione in gomma trasparente / *Transparent PVC rubber protection*



1 elemento <i>1 element</i>	CS20	ACP-1466
	CS25/32	ACP-10889
	CS50	ACP-10891
	CS80	ACP-10892
2 elementi <i>2 elements</i>	CS20	ACP-1466
	CS25/32	ACP-10889
	CS32	ACP-10890
	CS50	ACP-10891
	CS80	ACP-10892
3 elementi <i>3 elements</i>	CS20	ACP-1467
	CS25/32	ACP-10890
	CS50/80	ACP-10892
4 elementi <i>4 elements</i>	CS20	ACP-1467
	CS25	ACP-10890
	CS32	ACP-12481
	CS50	ACP-10892
	CS80	ACP-12792
5 elementi <i>5 elements</i>	CS20	ACP-1468
	CS25	ACP-12481
	CS32	ACP-12482
	CS50	ACP-12792
6 elementi <i>6 elements</i>	CS20	ACP-1468
	CS25	ACP-12481
	CS32	ACP-12483
	CS50	ACP-12792

Comando frontale protetto IP54 / *IP54 Protected front operator 78x60 h61 mm*

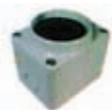

Max 2 elementi <i>2 elements max</i>	CS20	ACE-3150
---	------	----------

Custodia metallica comando laterale a leva IP55 113x95 h85 mm  
*IP55 Metal enclosure side lever 113x95 h85 mm*



Max 5 elementi / <i>5 elements max</i>	CS20/25	ACME-2403
Max 3 elementi / <i>3 elements max</i>	CS32	ACME-2403



Comando a leva IP55 / *IP55 Side lever operator 122x97 h79 mm*



Max 6 elementi / <i>6 elements max</i>	CS20/25	ACE-2401
Max 4 elementi / <i>4 elements max</i>	CS32	ACE-2401
Max 6 elementi / <i>6 elements max</i>	CS50	ACE-2402
Max 4 elementi / <i>4 elements max</i>	CS80	ACE-2402

Comando frontale IP54 130x95 h91 mm  
*IP54 front operator 130x95 h91 mm*



Max 4 elementi / <i>4 elements max</i>	CS16	ACE-2532
Max 4 elementi / <i>4 elements max</i>	CS20/25	ACE-2533
Max 3 elementi / <i>3 elements max</i>	CS32	ACE-2533
Max 3 elementi / <i>3 elements max</i>	CS50	ACE-2534
Max 2 elementi / <i>2 elements max</i>	CS80	ACE-2534

**Targhette fissaggio su foro 22mm / Plates for holes 22mm**

29,5x41 mm

ACT-22921	ACT-24447	ACT-24720	ACT-22850 neutra / <i>neutral</i> ACT-24143 neutra alluminio <i>neutral aluminum</i>

54x54 mm

ACT-24894	ACT-24906	ACT-24890	ACT-24897	ACT-24892	ACT-24907 neutra / <i>neutral</i>

**Targhette serie CS20/25/32 / Plates for CS20/25/32 series**

72x72 mm

ACT-20688	ACT-3813	ACT-20673	ACT-3814	ACT-20706	ACT-20772
ACT-20764	ACT-20742	ACT-20699	ACT-22456	ACT-20701	ACT-20733
				ACT-20830 neutra / <i>neutral</i>	
ACT-20704	ACT-20686	ACT-20690	ACT-20830	neutra / <i>neutral</i>	

ø 57 mm

ACT-25175	ACT-22714	ACT-10433 neutra / <i>neutral</i>

**Targhette serie CS20 mostrine finestra DIN45 / CS20 series frontal plates for DIN45 window**

Comando a manopola / *Control by knob*

ACT-25103	ACT-25138	ACT-25092	ACT-25120
ACT-25100	ACT-25102	ACT-25105	ACT-24919 neutra / <i>neutral</i>







Per comando a chiave / *Control by key*

ACT-25053	ACT-25088	ACT-25042	ACT-25070
ACT-25050	ACT-25052	ACT-25055	ACT-24914 neutra / <i>neutral</i>

# Serie CS-CP | CS-CP Series

## Accessori

## Accessories

Descrizione / Description	Serie / Series	Codice / Code	Descrizione / Description	Serie / Series	Codice / Code
 <p>Manopola a pressione / Pressure knob</p> <ul style="list-style-type: none"> <li>☑ da / from 5 mm Nera / Black ø 26 mm L38 mm CP12...16 ACM-P5-L38N</li> <li>☑ da / from 5 mm Rossa / Red ø 26 mm L38 mm CP12...16 ACM-P5-L38R</li> <li>☑ da / from 5 mm Gialla / Yellow ø 26 mm L38 mm CP12...16 ACM-P5-L38G</li> <li>☑ da / from 5 mm Nera / Black ø 38 mm L43 mm CP12...16 ACM-P5-L43N</li> <li>☑ da / from 5 mm Rossa / Red ø 38 mm L43 mm CP12...16 ACM-P5-L43R</li> <li>☑ da / from 5 mm Gialla / Yellow ø 38 mm L43 mm CP12...16 ACM-P5-L43G</li> </ul> <p>Manopola a vite / Screw knob</p> <ul style="list-style-type: none"> <li>☑ da / from 5 mm Nera / Black ø 26 mm L38 mm CP12...16 ACM-V5-L38N</li> <li>☑ da / from 5 mm Rossa / Red ø 26 mm L38 mm CP12...16 ACM-V5-L38R</li> <li>☑ da / from 5 mm Gialla / Yellow ø 26 mm L38 mm CP12...16 ACM-V5-L38G</li> <li>☑ da / from 5 mm Nera / Black ø 38 mm L43 mm CP12...16 ACM-V5-L43N</li> <li>☑ da / from 5 mm Rossa / Red ø 38 mm L43 mm CP12...16 ACM-V5-L43R</li> <li>☑ da / from 5 mm Gialla / Yellow ø 38 mm L43 mm CP12...16 ACM-V5-L43G</li> <li>☑ da / from 6 mm Nera / Black ø 38 mm L43 mm CS20...32 ACM-V6-L43N</li> <li>☑ da / from 6 mm Rossa / Red ø 38 mm L43 mm CS20...32 ACM-V6-L43R</li> <li>☑ da / from 6 mm Gialla / Yellow ø 38 mm L43 mm CS20...32 ACM-V6-L43G</li> </ul>			 <p>Protezione in gomma PVC trasparente flessibile ø 57 mm, L 70 mm ACP-F501 <i>Flexible transparent PVC rubber protection ø 57 mm, L 70 mm</i></p> <p>Protezione in gomma PVC trasparente flessibile ø 57 mm, L 103 mm ACP-F502 <i>Flexible transparent PVC rubber protection ø 57 mm, L 103 mm</i></p> <p>Supporto per protezioni flessibili ACP-F501 e ACP-F502 ø 57 mm, in materiale plastico nero / Support for flexible protection ACP-F501 and ACP-F502 ø 57 mm made in black thermoplastic material ACP-PF5</p> <p>Protezione semirigida trasparente con ghiera di tenuta ø 65 mm, L 73 mm ACP-S601 <i>Semi-rigid transparent protection with lock nut ø 65 mm, L 73 mm</i></p> <p>Protezione semirigida trasparente con ghiera di tenuta ø 65 mm, L 101 mm ACP-S602 <i>Semi-rigid transparent protection with lock nut ø 65 mm, L 101 mm</i></p> <p>Protezione semirigida trasparente con ghiera di tenuta ø 65 mm, L 129 mm ACP-S603 <i>Semi-rigid transparent protection with lock nut ø 65 mm, L 129 mm</i></p> <p>Protezione semirigida trasparente con ghiera di tenuta ø 65 mm, L 157 mm ACP-S604 <i>Semi-rigid transparent protection with lock nut ø 65 mm, L 157 mm</i></p> <p>Protezione semirigida trasparente con ghiera di tenuta ø 85 mm, L 80 mm ACP-S801 <i>Semi-rigid transparent protection with lock nut ø 85 mm, L 80 mm</i></p> <p>Protezione semirigida trasparente con ghiera di tenuta ø 85 mm, L 145 mm ACP-S802 <i>Semi-rigid transparent protection with lock nut ø 85 mm, L 145 mm</i></p> <p>Protezione semirigida trasparente con ghiera di tenuta ø 85 mm, L 210 mm ACP-S803 <i>Semi-rigid transparent protection with lock nut ø 85 mm, L 210 mm</i></p> <p>Protezione semirigida trasparente con ghiera di tenuta ø 85 mm, L 275 mm ACP-S804 <i>Semi-rigid transparent protection with lock nut ø 85 mm, L 275 mm</i></p>		
 <p>Manopola a vite / Screw knob</p> <ul style="list-style-type: none"> <li>☑ da / from 5 mm Nera / Black ø 21 mm L35 mm CP12...16 ACM-V5-L35N</li> <li>☑ da / from 5 mm Rossa / Red ø 21 mm L35 mm CP12...16 ACM-V5-L35R</li> <li>☑ da / from 5 mm Gialla / Yellow ø 21 mm L35 mm CP12...16 ACM-V5-L35G</li> </ul>			 <p>Guarnizione di tenuta IP-65 / IP65 seal gasket CP12...16 ACG-IP65</p> <p>Guarnizione di tenuta IP-54 / IP54 seal gasket CP12...16 ACG-IP54</p> <p>Guarnizione di tenuta IP-65 / IP65 seal gasket ACF-MP75 CP12...16 ACF-MP75</p>		
 <p>Staffe in materiale isolante per fissaggio fondoquadro con vite e/o su guida DIN CP12...16 ACD-CP <i>Plastic bracket for base mounting by screw and/or DIN Rail</i></p> <p>Staffe in metallo per fissaggio fondoquadro con vite CP12...16 ACS-CP-16 <i>Metal bracket for base mounting by screw</i></p>			 <p>Mostrina quadrata in materiale plastico 75x75 mm colore grigio CP12...16 ACF-MP75G <i>Squared actuator in thermoplastic material 75x75 mm grey color for round plate ø 59 mm</i></p> <p>Mostrina quadrata in materiale plastico 75x75 mm colore giallo CP12...16 ACF-MP75Y <i>Squared actuator in thermoplastic material 75x75 mm yellow color for round plate ø 59 mm</i></p>		

Targhetta per serie CP, come ordinare / Plates for CP series, how to order



ACT-	<input type="checkbox"/>	<input type="checkbox"/> <input type="checkbox"/>	<input type="checkbox"/>	<input type="checkbox"/> <input type="checkbox"/>	<input type="checkbox"/> <input type="checkbox"/>
ACT-Serie Series	Tipo Type	Dimensioni Dimensions	Colore Colour	Schema elettrico Diagram	Angolo di scatto Switching angle
	Q = Quadra / Square	48 = 48x48 64 = 64x64	N = Nero / Black G = Grigio / Gray	Vedi pagina schemi elettrici Es. Interruttore unipolare 0-1 = 01 Es. Commutatore di linea bipolare 1-0-2= 06	30 = 30° 45 = 45° 60 = 60° 90 = 90°
	T = Tonda / Round	47 = ø 47 52 = ø 52 59 = ø 59	R = Rosso / Red Y = Giallo / Yellow A = Alluminio anodizzato A = Anodized aluminum	See page diagrams, examples: 1 pole switch 0-1 = 01 Changeover switch 1-0-2 = 06	

# Serie CS-CP | CS-CP Series

## Schemi elettrici

### Diagrams

#### Serie CS/CP 12/630 | CS/CP Series 12/630

**01** Interruttore unipolare  
1 pole switch



**02** Interruttore bipolare  
2 poles switch

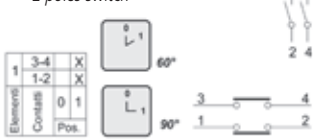

**03** Interruttore tripolare  
3 poles switch

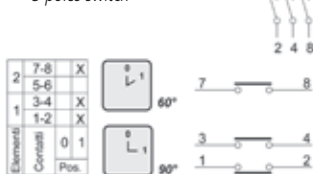

**04** Interruttore quadripolare  
4 poles switch

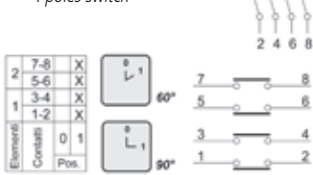

**05** Commutatore di linea unipolare  
1 pole changeover switch



**06** Commutatore di linea bipolare  
2 poles changeover switch



**07** Commutatore di linea tripolare  
3 poles changeover switch

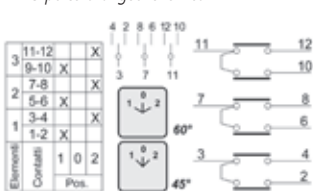

**08** Invertitore di marcia tripolare  
3 poles reversing switch

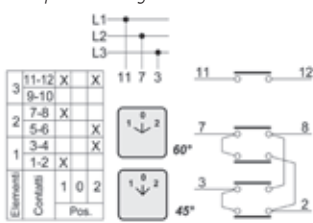

**09** Commutatore di poli tripolare Dahlander  
3 poles Dahlander pole switch

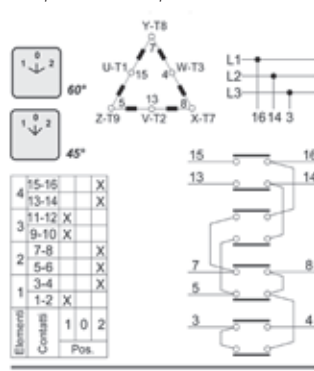

**10** Commutatore Star-Delta  
Star-Delta switch

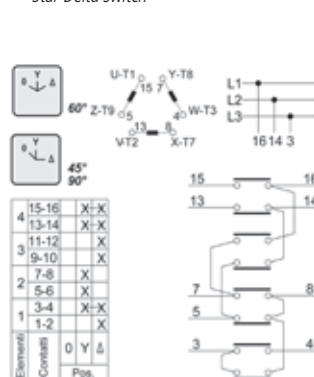

**11** Comm. di poli tripolare con inversione  
3 poles switch with revers

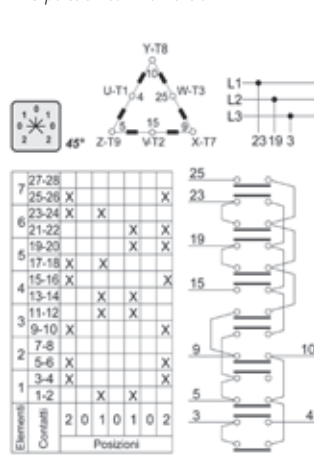

**12** Comm. Star-Delta con inversione  
Star-Delta switch with revers

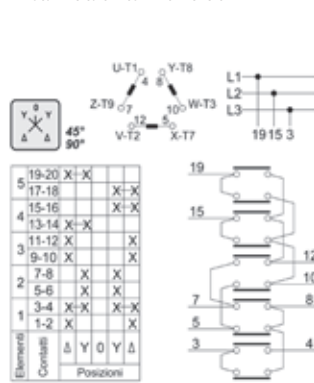

**14** Comm. amperometrico per misure dirette  
(senza interruzione di fase)  
Ammeter switch for direct measurement  
(without interruption phase)

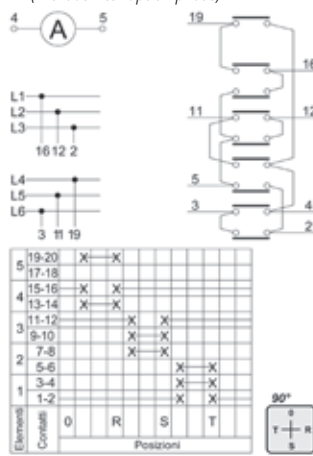

**15** Comm. voltmetrico per 3 tensioni di fase  
Voltmeter switch for 3 phase voltages

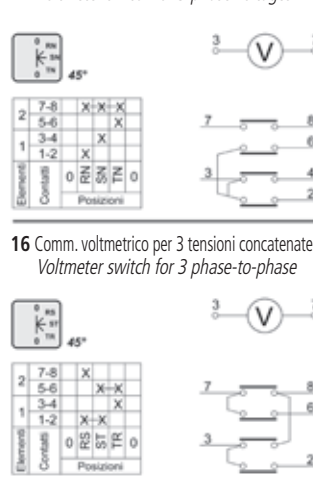

**17** Comm. voltmetrico per tensioni concatenate di 2 linee trifase  
Voltmeter switch for phase-to-phase of 2 tri-phase lines

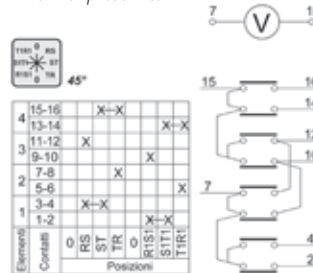

**18** Comm. voltmetrico per 3 tensioni di fase e 3 tensioni concatenate  
Voltmeter switch for 3 phase voltages and 3 phase-to-phase

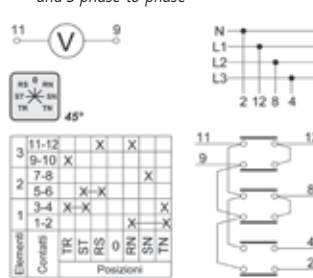

**19** Comm. voltmetrico per 1 tensione di fase e 3 tensioni concatenate  
Voltmeter switch for 1 phase voltage and 3 phase-to-phase

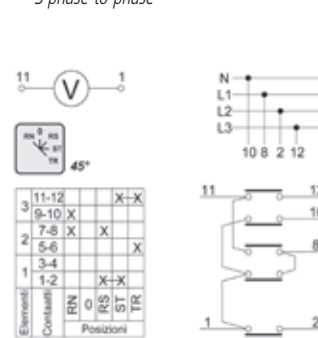

**20** Comm. amperometrico unipolare per 1 riduttore di corrente  
1 pole ammeter switch for 1 current reducer

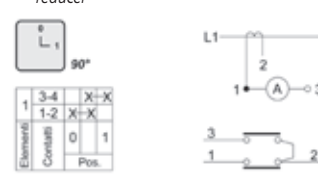

**22** Comm. amperometrico unipolare per 3 riduttori di corrente  
1 pole ammeter switch for 3 current reducers

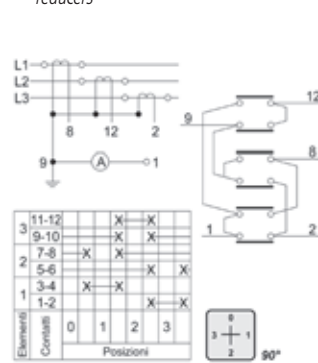

**23** Comm. amperometrico unipolare per 4 riduttori di corrente  
1 pole ammeter switch for 4 current reducers

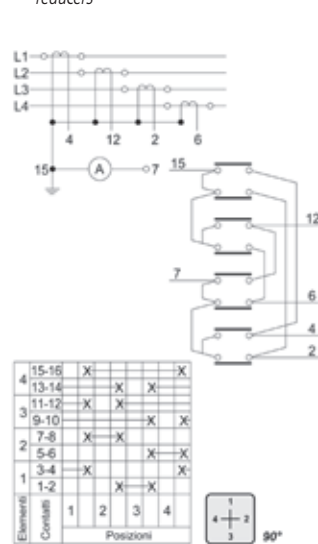

**25** Commutatore amperometrico bipolare per 3 riduttori di corrente  
*2 poles ammeter switch for 3 current reducers*

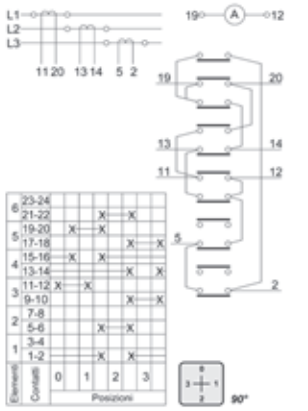

**29** Interruttore bipolare con fase ausiliaria  
*2 poles switch with auxiliary phase*

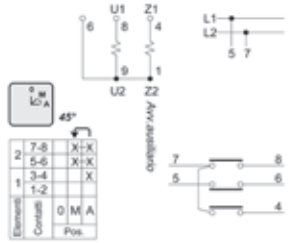

**30** Interruttore bipolare con fase ausiliaria e inversione  
*2 poles switch with auxiliary phase and reverse*

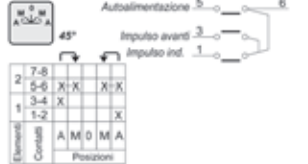

**32** Invertitore di marcia bipolare con fase ausiliaria  
*2 poles reversing switch with aux. phase*

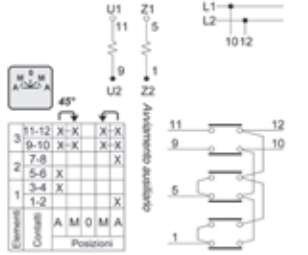

**37** Invertitore di marcia bipolare con condensatore  
*2 poles start reversing switch with capacitor*

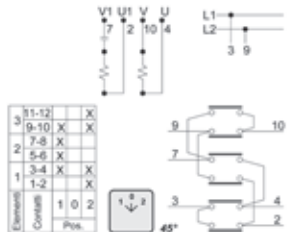

**38** Commutatore unipolare a tre vie  
*1 pole switch with three-pos.*



**41** Commutatore unipolare a due vie  
*1 pole switch with two-pos.*



**42** Commutatore bipolare a due vie  
*2 poles switch with two-pos.*

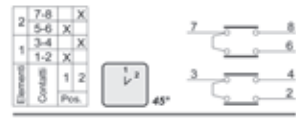

**43** Commutatore tripolare a due vie  
*3 poles switch with two-pos.*



**44** Commutatore quadripolare a due vie  
*4 poles switch with two-pos.*



**45** Commutatore di linea quadripolare  
*4 poles changeover switch*



**46** Commutatore unipolare a quattro vie  
*1 pole switch with four-pos.*

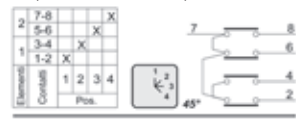

**47** Commutatore bipolare a quattro vie  
*2 poles switch with four-pos.*

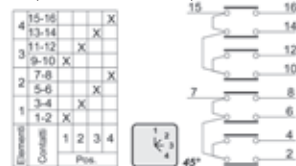

**48** Commutatore tripolare a quattro vie  
*3 poles switch with four-pos.*

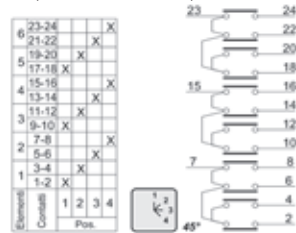

**49** Commutatore unipolare a sei vie  
*1 pole switch with six-pos.*

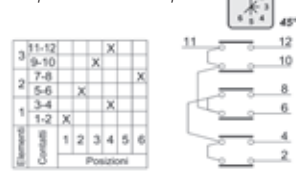

**50** Commutatore bipolare a sei vie  
*2 poles switch with six-pos.*

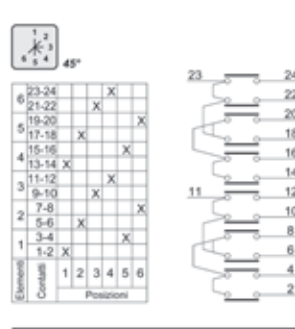

**51** Commutatore tripolare a sei vie  
*3 poles switch with six-pos.*

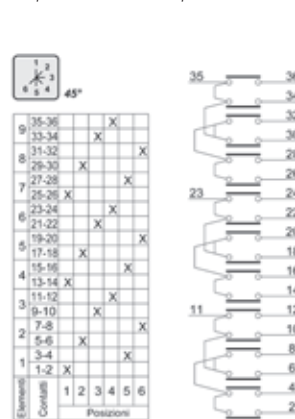

**52** Commutatore unipolare a dieci vie  
*1 pole switch with ten-pos.*

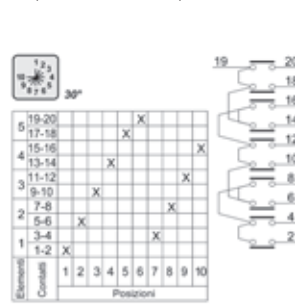

**53** Commutatore unipolare a dodici vie  
*1 pole switch with twelve-pos.*

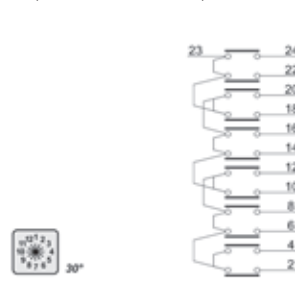

**54** Commutatore Star-Delta  
*Star-Delta switch*

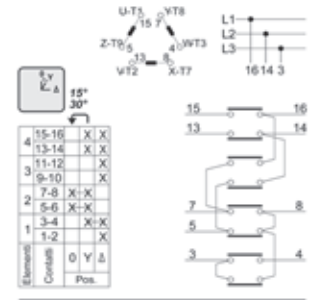

**55** Commutatore Star-Delta con inversione  
*Star-Delta switch with reverse*

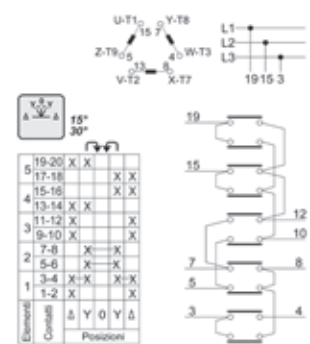

**57** Commutatore unipolare a tre vie +0  
*1 pole switch with three-pos. +0*

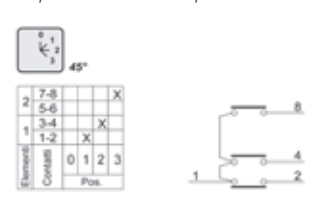

**58** Commutatore unipolare a quattro vie +0  
*1 pole switch with four-pos. +0*

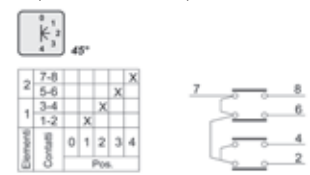

**59** Commutatore unipolare a cinque vie +0  
*1 pole switch with five-pos. +0*

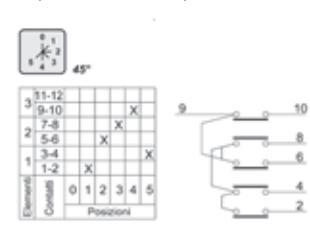

**60** Commutatore bipolare a tre vie +0  
*2 poles switch with three-pos. +0*

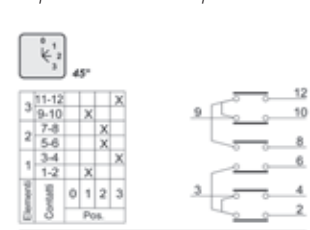

### Serie CS/CP 12/630 | CS/CP Series 12/630

**61** Commutatore tripolare a tre vie +0  
3 poles switch with three-pos. +0

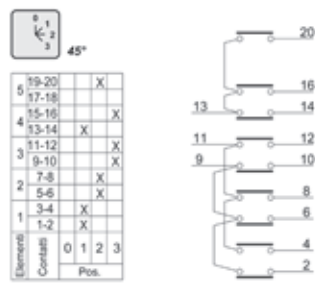

**62** Commutatore bipolare a quattro vie +0  
2 poles switch with four-pos. +0

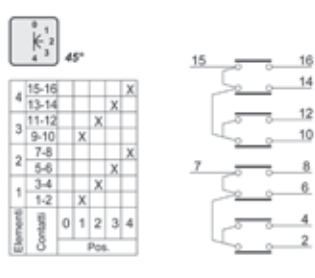

**63** Commutatore tripolare a quattro vie +0  
3 poles switch with four-pos. +0

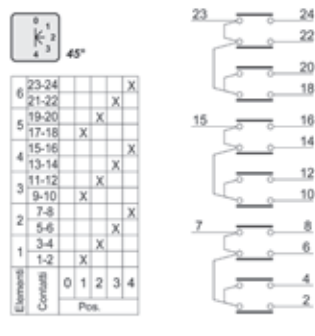

**64** Commutatore unipolare a sei vie +0  
1 pole switch with six-pos. +0

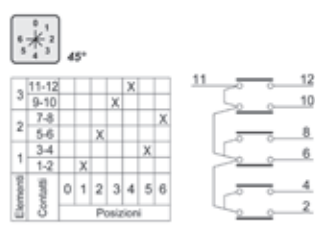

**65** Commutatore bipolare a sei vie +0  
2 poles switch with six-pos. +0

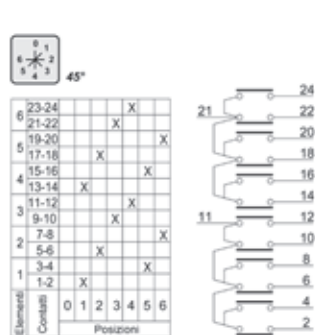

**66** Commutatore tripolare a sei vie +0  
3 poles switch with six-pos. +0



**67** Commutatore unipolare a sette vie +0  
1 pole switch with seven-pos. +0

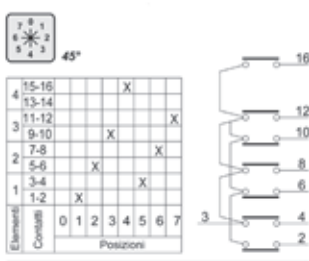

**70** Commutatore Star-Delta  
Star-Delta switch

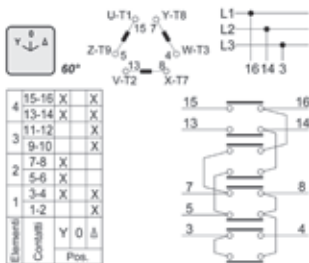

### Serie CS16 | CS16 Series

**01** Interruttore unipolare  
1 pole switch



**01** Interruttore bipolare  
2 poles switch



**03** Interruttore tripolare  
3 poles switch

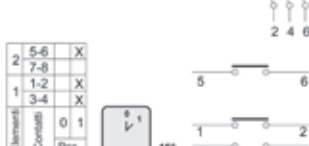

**04** Interruttore quadripolare  
4 poles switch



**05** Commutatore di linea unipolare  
1 pole changeover switch



**06** Commutatore di linea bipolare  
2 poles changeover switch

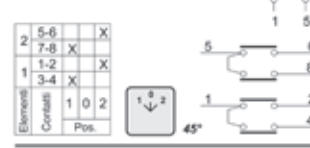

**07** Commutatore di linea tripolare  
3 poles changeover switch



**08** Interruttore di marcia tripolare  
3 poles start switch

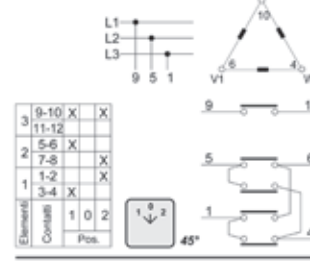

**16** Commutatore voltmetrico per tre tensioni concatenate  
Voltmeter switch for 3 phase-to-phase

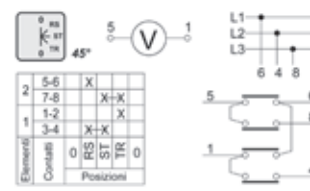

**18** Commutatore voltmetrico per tre tensioni di fase e tre tensioni concatenate  
Voltmeter switch for 3 phase voltages and 3 phase-to-phase

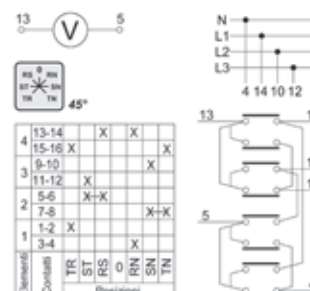

**19** Commutatore voltmetrico per una tensione di fase e tre tensioni concatenate  
Voltmeter switch for 1 phase voltage and 3 phase-to-phase

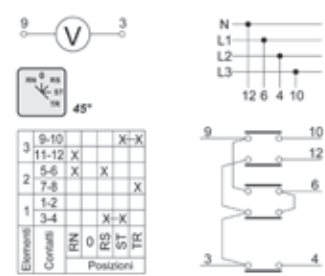

**22** Commutatore amperometrico unipolare per tre riduttori di corrente  
1 pole ammeter switch for 3 current reducers

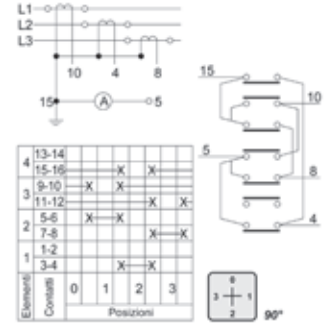

**45** Commutatore di linea quadripolare  
4 poles changeover switch

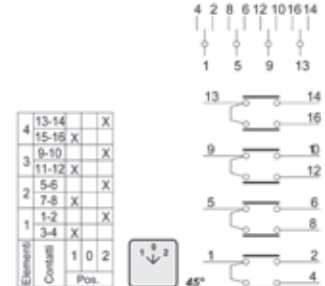

**57** Commutatore unipolare a tre vie +0  
1 pole switch with three-pos. +0

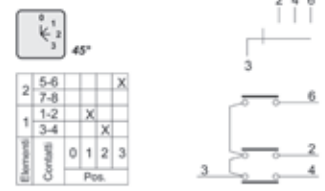

**67** Commutatore unipolare a sette vie +0  
1 pole switch with seven-pos. +0

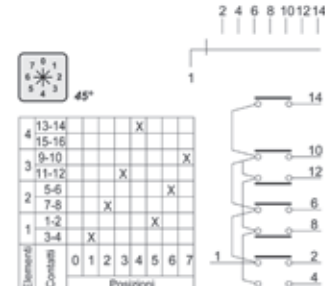

# Serie CS-CP | CS-CP Series

## Modulo richiesta schemi speciali

### Request form special diagrams

Data/Date \_\_\_\_\_ Ordine N°/Order N. \_\_\_\_\_

Azienda / Company \_\_\_\_\_

Contatto Sig./ Contact Mr. \_\_\_\_\_

Tel. / Ph. \_\_\_\_\_ Fax \_\_\_\_\_

Quantità / Quantity \_\_\_\_\_ Consegna / Delivery date \_\_\_\_\_

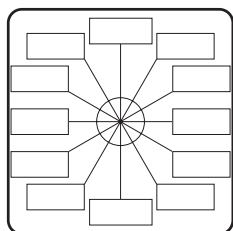

30°  
 60°

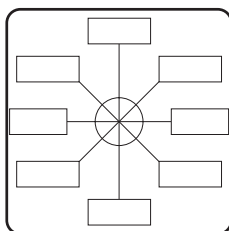

45°  
 90°

## Serie CS20-630 / CP12-16

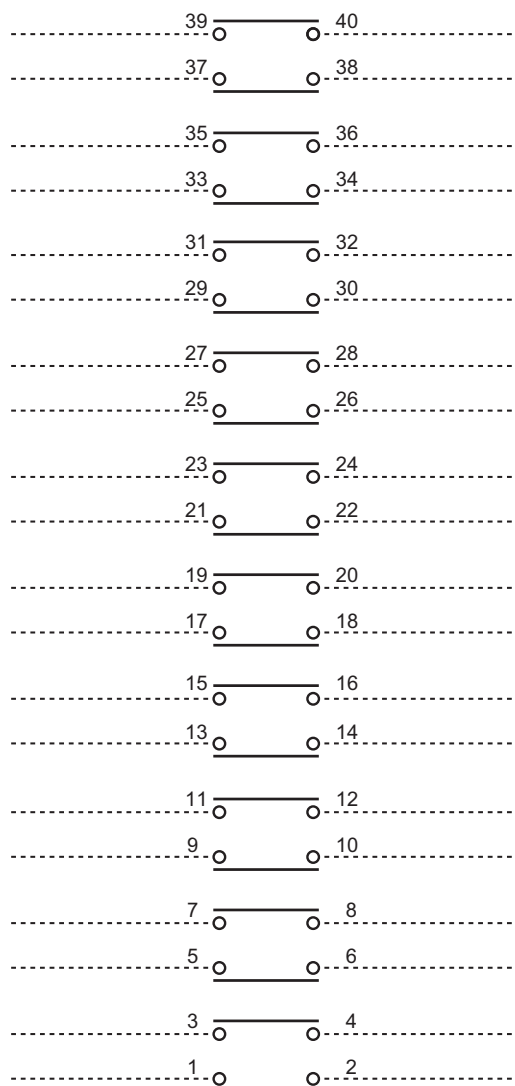

Elementi Banks	Contatti Terminals	Posizioni / Positions									
		1	2	3	4	5	6	7	8	9	10
10	39 - 40										
	37 - 38										
9	35 - 36										
	33 - 34										
8	31 - 32										
	29 - 30										
7	27 - 28										
	25 - 26										
6	23 - 24										
	21 - 22										
5	19 - 20										
	17 - 18										
4	15 - 16										
	13 - 14										
3	11 - 12										
	9 - 10										
2	7 - 8										
	5 - 6										
1	3 - 4										
	1 - 2										

**X** = Contatto chiuso / Contact closed       = Ritorno automatico / Spring return  
**X-X** = Contatto chiuso senza interruzione / Contact closed in several positions  
**Nessun Simbolo / No symbol** = Contatto aperto / Contact open

Serie / Series \_\_\_\_\_

Corrente nominale / Rated current  $I_g$  AC-21A (A) \_\_\_\_\_

Fissaggio retroquadro/Front mounting       Fissaggio fondoquadro/Base mounting       Fissaggio centrale/Central mounting

Attuatore / Actuator \_\_\_\_\_

Note / Notes \_\_\_\_\_

# Serie CS-CP | CS-CP Series

## Modulo richiesta schemi speciali - esempio

### Request Form Special diagrams - example

Data/Date \_\_\_\_\_ Ordine N°/Order N. **000/00**

Azienda / Company **VERDI & C.**

Contatto Sig./ Contact Mr. **BIANCHI**

Tel. / Ph. **02 222222** Fax **02 333333**

Quantità / Quantity **100 pz** Consegna / Delivery date **10 gg.**

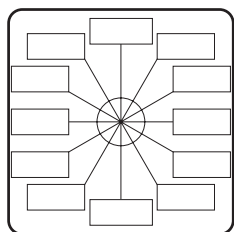

30°  
 60°

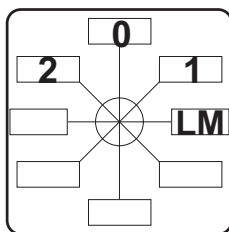

45°  
 90°

## Serie CS20-630 / CP12-16

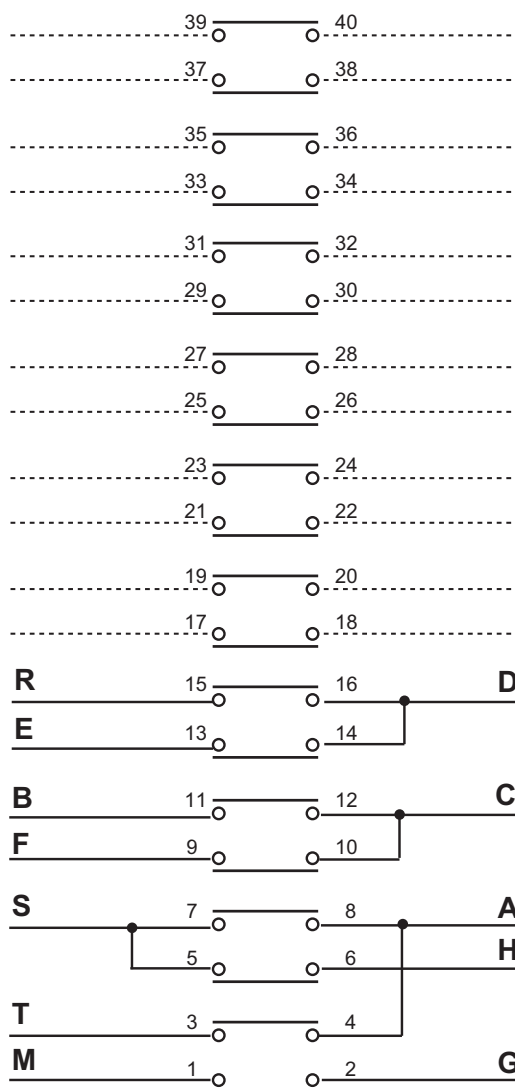

10	39 - 40																			
	37 - 38																			
9	35 - 36																			
	33 - 34																			
8	31 - 32																			
	29 - 30																			
7	27 - 28																			
	25 - 26																			
6	23 - 24																			
	21 - 22																			
5	19 - 20																			
	17 - 18																			
4	15 - 16																			
	13 - 14																			
3	11 - 12																			
	9 - 10																			
2	7 - 8																			
	5 - 6																			
1	3 - 4																			
	1 - 2																			
Elementi Banks	Contatti Contacts																			
	Posizioni / Positions																			

**X** = Contatto chiuso / Contact closed  
**X-X** = Contatto chiuso senza interruzione / Contact closed in several positions  
 Nessun Simbolo / No symbol = Contatto aperto / Contact open

Serie / Series **CS20**

Corrente nominale / Rated current I AC-21A (A) \_\_\_\_\_

Fissaggio retroquadro/Front mounting  Fissaggio fondoquadro/Base mounting  Fissaggio centrale/Central mounting

Attuatore / Actuator **72X72mm**

Note / Notes \_\_\_\_\_



# AUSILIARI DI COMANDO

## CONTROL SWITCHES



### Serie PM

- Lampade di segnalazione LED monoblocco
- Pulsanti non luminosi monoblocco
- Selettori non luminosi monoblocco 2 e 3 posizioni
- Ronzatori e potenziometri monoblocco
- Pulsanti multifunzione modulari
- Pulsanti di emergenza monoblocco e modulare
- Pulsanti di emergenza in cassetta
- Pulsantiere di emergenza 3 fori
- Pulsantiere serie LIFT per manutenzione ascensori 4 e 5 fori

### PM series

- Monoblock LED indicator
- Monoblock operators unlighted
- Monoblock selector switch unlighted 2 and 3 positions
- Monoblock buzzers and potentiometers
- Modular multifunction pushbutton
- Monoblock or Modular emergency stop
- Emergency stop in enclosure
- Emergency pushbutton stations 3 holes
- Inspection pushbutton stations 4 and 5 holes LIFT series

# Serie PM ø 22 mm | PM Series ø 22 mm

## Lampade di segnalazione LED monoblocco

### Monoblock LED indicators

#### 5 LUMEN



	12V AC/DC	24V AC/DC	48V AC/DC	110V AC	110V DC	240V AC	220V DC
●	MNL0112	MNL01124	MNL01148	MNL011110AC	MNL011110DC	MNL011240AC	MNL011220DC
●	MNL0212	MNL02124	MNL02148	MNL021110AC	MNL021110DC	MNL021240AC	MNL021220DC
●	MNL0312	MNL03124	MNL03148	MNL031110AC	MNL031110DC	MNL031240AC	MNL031220DC
●	MNL0412	MNL04124	MNL04148	MNL041110AC	MNL041110DC	MNL041240AC	MNL041220DC
○	MNL0512	MNL05124	MNL05148	MNL051110AC	MNL051110DC	MNL051240AC	MNL051220DC

#### 20 LUMEN



	24V AC/DC	48V AC/DC	110V AC	110V DC	240V AC	220V DC
●	MNL01124L20	MNL01148L20	MNL011110ACL20	MNL011110DCL20	MNL011240ACL20	MNL011220DCL20
●	MNL02124L20	MNL02148L20	MNL021110ACL20	MNL021110DCL20	MNL021240ACL20	MNL021220DCL20
●	MNL03124L20	MNL03148L20	MNL031110ACL20	MNL031110DCL20	MNL031240ACL20	MNL031220DCL20
●	MNL04124L20	MNL04148L20	MNL041110ACL20	MNL041110DCL20	MNL041240ACL20	MNL041220DCL20
○	MNL05124L20	MNL05148L20	MNL051110ACL20	MNL051110DCL20	MNL051240ACL20	MNL051220DCL20

#### 10 LUMEN intermittenti / Intermittent



	24V AC/DC	48V AC/DC	110V AC	110V DC	240V AC	220V DC
●	MNL01124L10	MNL01148L10	MNL011110ACL10	MNL011110DCL10	MNL011240ACL10	MNL011220DCL10
●	MNL02124L10	MNL02148L10	MNL021110ACL10	MNL021110DCL10	MNL021240ACL10	MNL021220DCL10
●	MNL03124L10	MNL03148L10	MNL031110ACL10	MNL031110DCL10	MNL031240ACL10	MNL031220DCL10
●	MNL04124L10	MNL04148L10	MNL041110ACL10	MNL041110DCL10	MNL041240ACL10	MNL041220DCL10
○	MNL05124L10	MNL05148L10	MNL051110ACL10	MNL051110DCL10	MNL051240ACL10	MNL051220DCL10

#### Caratteristiche tecniche / Technical details

Tensione di esercizio / Operating voltage	-20% / +10% della tensione nominale / off rated voltage
Durata / Life	0,1 mio. ore acc. / 0,1 million burning hour
Frequenza di esercizio / Operating Frequency	50/60 HZ
Temperatura di esercizio / Operating temperature	-25°C ...+65°C
Temperatura di stoccaggio / Storage temperature	-30°C ...+70°C
Sezioni massime collegabili / Wire Termination Capacity	0,5 / 1,5 / 2,5 mm <sup>2</sup>
Forza di serraggio / Terminal torque	0,8 Nm
Grado di protezione / Protection degree	IP 65 a pannello / IP65 above panel Terminali IP20 / IP20 for terminals
Approvazioni / Approvals	CE, UL

#### Dimensioni / Dimension mm

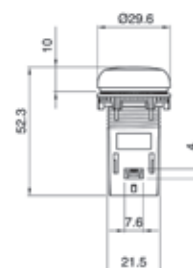

# Serie PM ø 22 mm | PM Series ø 22 mm

## Pulsanti monoblocco non luminosi

### Monoblock operators unlighted

#### Rasato, contatti integrati / Flushed head, contact integrated



	1NO	1NC	1NO+1NC	2NO	2NC
●	MPPB0110	MPPB0120	MPPB0130	MPPB0150	MPPB0160
●	MPPB0210	MPPB0220	MPPB0230	MPPB0250	MPPB0260
●	MPPB0310	MPPB0320	MPPB0330	MPPB0350	MPPB0360
●	MPPB0610	MPPB0620	MPPB0630	MPPB0650	MPPB0660
●	MPPB0410	MPPB0420	MPPB0430	MPPB0450	MPPB0460
○	MPPB0510	MPPB0520	MPPB0530	MPPB0550	MPPB0560

#### Con collare di protezione, contatti integrati / Flushed head extended collar, contact integrated



	1NO	1NC	1NO+1NC	2NO	2NC
●	MPPB0110	MPPB0120	MPPB0130	MPPB0150	MPPB0160
●	MPPB0210	MPPB0220	MPPB0230	MPPB0250	MPPB0260
●	MPPB0310	MPPB0320	MPPB0330	MPPB0350	MPPB0360
●	MPPB0610	MPPB0620	MPPB0630	MPPB0650	MPPB0660
●	MPPB0410	MPPB0420	MPPB0430	MPPB0450	MPPB0460
○	MPPB0510	MPPB0520	MPPB0530	MPPB0550	MPPB0560

#### Sporgente, contatti integrati / Extended head, contact integrated



	1NO	1NC	1NO+1NC	2NO	2NC
●	MPEB0110	MPEB0120	MPEB0130	MPEB0150	MPEB0160
●	MPEB0210	MPEB0220	MPEB0230	MPEB0250	MPEB0260
●	MPEB0310	MPEB0320	MPEB0330	MPEB0350	MPEB0360
●	MPEB0610	MPEB0620	MPEB0630	MPEB0650	MPEB0660
●	MPEB0410	MPEB0420	MPEB0430	MPEB0450	MPEB0460
○	MPEB0510	MPEB0520	MPEB0530	MPEB0550	MPEB0560

#### Dimensioni / Dimensions mm

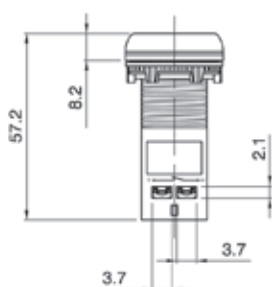

Rasato / Flushed head

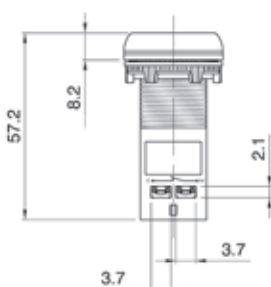

Con collare / Extended collar

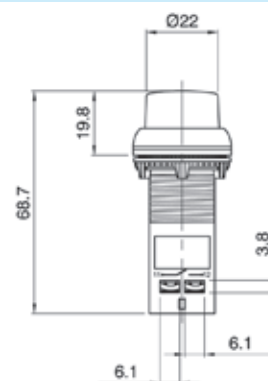



Sporgente / Extended head

# Serie PM ø 22 mm | PM Series ø 22 mm



## Selettori monoblocco non luminosi

### Monoblock selector switches unlighted



#### Comando a manopola, 2 posizioni, contatti integrati / Short handle, 2 positions, contact integrated

	1NO	1NC	1NO+1NC	2NO	2NC
 	MSB061A0	MSB062A0	MSB063A0	MSB065A0	MSB066A0
	MSB061C0	MSB062C0	MSB063C0	MSB065C0	MSB066C0
	MSB061B0	MSB062B0	MSB063B0	MSB065B0	MSB066B0



#### Comando a chiave, 2 posizioni, contatti integrati / Key selector, 2 positions, contact integrated

	1NO	1NC	1NO+1NC	2NO	2NC
 	MKB61A0	MKB62A0	MKB63A0	MKB65A0	MKB66A0
	MKB61B0	MKB62B0	MKB63B0	MKB65B0	MKB66B0

#### Comando a manopola, 3 posizioni, contatti integrati / Short handle, 3 positions, contact integrated

	1NO+1NC 1NO a sinistra/left	1NC+1NO 1NO a destra/right	2NO	2NC
 	MSB063D0	MSB064D0	MSB065D0	MSB066D0
	MSB063E0	MSB064E0	MSB065E0	MSB066E0

#### Comando a chiave, 3 posizioni, contatti integrati / Key selector, 3 positions, contact integrated

	1NO+1NC 1NO a sinistra/left	1NC+1NO 1NO a destra/right	2NO	2NC
 	MKB63D0	MKB64D0	MKB65D0	MKB66D0
	MKB63E0	MKB64E0	MKB65E0	MKB66E0

#### Dimensioni / Dimensions mm

#### Posizioni / Positions

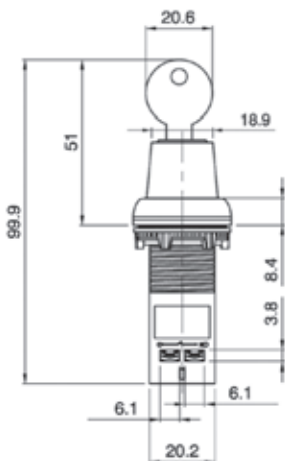
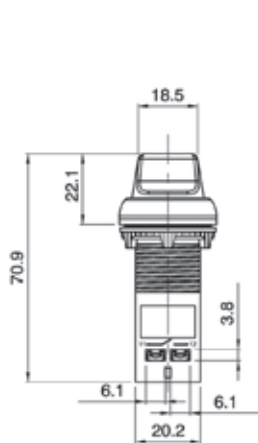

# Serie PM ø 22 mm | PM Series ø 22 mm

## Ronzatori, Potenzimetri e pulsanti multifunzione

### Buzzers, Potentiometers and multifunction pushbuttons

#### Ronzatore monoblocco 80 dB / Monoblock buzzer 80 dB

	240VAC	110VAC	64VAC/DC	48VAC/DC	30VAC/DC	24VAC/DC	12VAC/DC
	MB03240AC	MB03110AC	MB0364	MB0348	MB0330	MB0324	MB0312

#### Caratteristiche tecniche / Technical details

Tensione di esercizio / Operating Voltage	-20% ... +10% della tensione nominale d'impiego / of rated voltage
Durata di vita / Life	0.1 milioni di ore sotto tensione / million burning hour
Frequenza d'impiego / Operating Frequency	50 / 60 Hz
Temperatura di esercizio / Operating Temperature	-25°C ... 65°C
Temperatura di stoccaggio / Storage Temperature	-30°C ... 70°C
Sezioni massime collegabili / Wire Termination Capacity	0.5mm <sup>2</sup> , 1.5 - 2.5 mm <sup>2</sup>
Coppia di Serraggio / Terminal Torque	0.8 Nm
Tenuta ad Impulso / Surge Test	2kV
Test HV per 60 sec. / HV test for 60 sec.	1.5kV
Grado di protezione / Protection Degree	Retro pannello / Above panel: IP65 - Terminali / For terminals: IP20
Omologazioni / Approvals	CE, UL

#### Dimensioni / Dimension mm

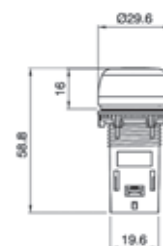

#### Potenzimetro monoblocco / Monoblock potentiometer

	1KΩ	2KΩ	5KΩ	10KΩ
	MVM1	MVM2	MVM5	MVM10







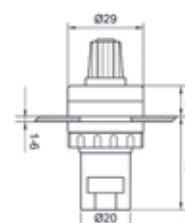

#### Caratteristiche tecniche / Technical details

Resistenza / Resistance	1KΩ, 2KΩ, 5KΩ, 10KΩ
Potenza nominale / Rated Power	Lineare / Linear 1,5W (70°C)
Grado di Protezione / Protection Degree	Retro pannello / Above panel: IP65 - Terminali / For terminals: IP20
Resistenza d'isolamento / Isolation Resistance	min. 10M (500VDC)
Temperatura di esercizio / Operating Temperature	-5°C ... 40°C
Temperatura di stoccaggio / Storage Temperature	-30°C ... 70°C
Materiale resistivo / Resistive element	CERMET
Corsa meccanica / Turning range	270°±15°
Tolleranza resistiva / Resistance Tolerance	±10%
Rigidità dielettrica / Dielectric Strength	±1750Vrms
Massima tensione di Esercizio / Maximum operating voltage (V)	38,70 - 86,60 - 122,50

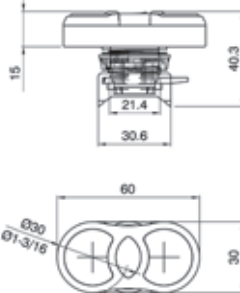
#### Dimensioni / Dimension mm



#### Pulsanti multifunzioni modulari / Modular multifunction pushbutton

Luminoso / Lighted	Non luminoso / Unlighted	Dimensioni / Dimension mm
		
		
		
		
OMB121	OMB120	
OMB561	OMB560	
OMB36AH1	OMB36AH0	
	OMB56UD0	

# Serie PM ø 22 mm | PM Series ø 22 mm

## Pulsanti di emergenza

### Emergency stop

#### Monoblocco, contatti integrati, instabile / Monoblock, contact integrated, momentary

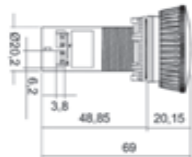
		1NC	1NO+1NC	2NC	Dimensioni / Dimension mm
	●	ME012MO	ME013MO	ME016MO	
	●	ME022MO	ME023MO	ME026MO	
	●	ME032MO	ME033MO	ME036MO	
	●	ME062MO	ME063MO	ME066MO	

#### Monoblocco, contatti integrati, sblocco a rotazione / Monoblock, contact integrated, twist to release

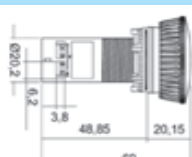
		1NC	1NO+1NC	2NC	Dimensioni / Dimension mm
	●	ME012RO	ME013RO	ME016RO	
	●	ME022RO	ME023RO	ME026RO	
	●	ME032RO	ME033RO	ME036RO	
	●	ME062RO	ME063RO	ME066RO	

#### Monoblocco, contatti integrati, sblocco a trazione / Monoblock, contact integrated, push-pull

		1NC	1NO+1NC	2NC	Dimensioni / Dimension mm
	●	ME012PO	ME013PO	ME016PO	

#### Modulare, sblocco a rotazione / Modular, twist to release

				Dimensioni / Dimension mm
	●	OE01RBO		

#### Modulare, sblocco a trazione / Modular, push-pull

				Dimensioni / Dimension mm
	●	OE01PBO		

#### Modulare, instabile / Modular, momentary

		Dimensioni / Dimension mm
	●	OE01MBO
	●	OE02MBO
	●	OE03MBO
	●	OE06MBO

#### Elementi di contatto a vite / Screw contact elements

		Dimensioni / Dimension mm
	●	1NC CN01
	●	1NO CN03

# Serie PM ø 22 mm | PM Series ø 22 mm

## Pulsanti di emergenza in cassetta

### Emergency stop in enclosure

#### Monoblocco, contatti integrati, sblocco rotazione

#### Monoblock, contact integrated, twist to release

1NC	1NC + 1NO	2NC
-----	-----------	-----



B1MA001	B1MA002	B1MA003
---------	---------	---------

Disegno A / Drawing A

#### Monoblocco, contatti integrati, sblocco a trazione

#### Monoblock, contact integrated, push-pull

1NC	1NC + 1NO	2NC
-----	-----------	-----



B1MA004	B1MA005	B1MA006
---------	---------	---------

Disegno A / Drawing A

#### Modulare, contatti inclusi, sblocco a rotazione

#### Modular, contact included, twist to release

1NC	1NC + 1NO	2NC
-----	-----------	-----



B10A001	B10A002	B10A003
---------	---------	---------

Disegno A / Drawing A

#### Modulare, contatti inclusi, sblocco a rotazione, visivo

#### Modular, contact included, twist to release, vision

1NC	1NC + 1NO	2NC
-----	-----------	-----



B10A007	B10A008	B10A009
---------	---------	---------

Disegno B / Drawing B

#### Modulare, contatti inclusi, sblocco a trazione

#### Modular, contact included, push-pull

1NC	1NC + 1NO	2NC
-----	-----------	-----



B10A004	B10A005	B10A006
---------	---------	---------

Disegno A / Drawing A

#### Modulare, contatti inclusi, sblocco a trazione, visivo

#### Modular, contact included, push-pull, vision

1NC	1NC + 1NO	2NC
-----	-----------	-----



B10A010	B10A011	B10A012
---------	---------	---------

Disegno B / Drawing B

#### Dimensioni / Dimension mm

Disegno A / Drawing A

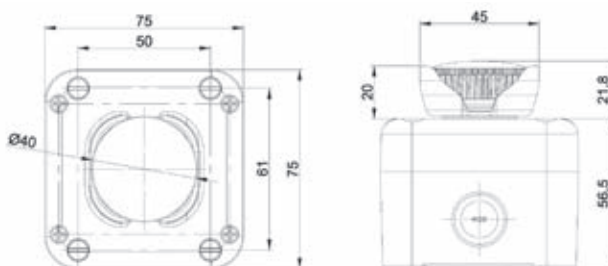

Disegno B / Drawing B

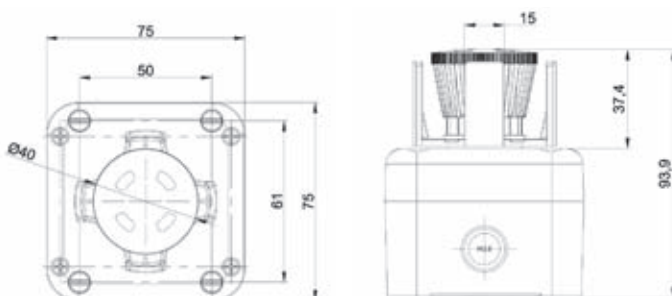

# Serie PM ø 22 mm | PM Series ø 22 mm

## Pulsantiera di emergenza 3 fori

### Emergency pushbutton stations 3 holes

#### Pulsante di emergenza monoblocco sblocco a trazione, allarme e presa

##### Monoblock e-stop push-pull, alarm and socket



Pulsante emergenza / E-stop	Allarme / Alarm	Presa / Socket	Codice / Code	Dimensioni / Dimension mm
1NC	2NO	Universale / Universal	B3MC001	Vedi pag. 52 disegno A See page 52 drawing A
1NC+1NO	1NC+1NO	Universale / Universal	B3MC002	
2NC	2NO	Universale / Universal	B3MC003	
1NC	2NO	Schuko	B3MC004	
1NC+1NO	1NC+1NO	Schuko	B3MC005	
2NC	2NO	Schuko	B3MC006	

#### Pulsante di emergenza monoblocco sblocco a rotazione, luce e presa

##### Monoblock e-stop twist to release, light and socket



Pulsante emergenza / E-stop	Luce / Light	Presa / Socket	Codice / Code	Dimensioni / Dimension mm
1NC	2NO	Universale / Universal	B3MC007	Vedi pag. 52 disegno A See page 52 drawing A
1NC+1NO	1NC+1NO	Universale / Universal	B3MC008	
2NC	2NO	Universale / Universal	B3MC009	
1NC	2NO	Schuko	B3MC010	
1NC+1NO	1NC+1NO	Schuko	B3MC011	
2NC	2NO	Schuko	B3MC012	

#### Pulsante di emergenza monoblocco sblocco a trazione, allarme-luce e presa

##### Monoblock e-stop push-pull, alarm-light and socket



Pulsante emergenza / E-stop	Allarme / alarm	Luce / Light	Presa / Socket	Codice / Code	Dimensioni / Dimension mm
1NC	1NO	1NO	Universale / Universal	B3MOC007	Vedi pag. 52 disegno B See page 52 drawing B
2NC	1NO	1NO	Universale / Universal	B3MOC008	
1NO	1NO	1NO	Schuko	B3MOC009	
2NC	1NO	1NO	Schuko	B3MOC010	

#### Pulsante di emergenza modulare visivo sblocco a trazione, interruttore luce e presa

##### Modular e-stop vision push-pull, light switch and socket



Pulsante emergenza / E-stop	Interrutt. luce / Light switch	Presa / Socket	Codice / Code	Dimensioni / Dimension mm
1NC	1NO	Universale / Universal	B3MOC001	Vedi pag. 52 disegno A See page 52 drawing A
2NC	1NO	Universale / Universal	B3MOC002	
1NC+1NO	1NC+1NO	Universale / Universal	B3MOC003	
1NO	1NO	Schuko	B3MOC004	
2NC	1NO	Schuko	B3MOC005	
1NC+1NO	1NC+1NO	Schuko	B3MOC006	

#### Pulsante di emergenza monoblocco sblocco a rotazione, LED 20 lumen e ronzatore

##### Monoblock e-stop twist to release, LED 20 lumen and buzzer



Pulsante emergenza / E-stop	LED	Ronzatori / Buzzer	Codice / Code	Dimensioni / Dimension mm
1NC	24V AC/DC	24V AC/DC	B3MA005	Vedi pag. 52 disegno C See page 52 drawing C
1NC	240V AC	240V AC	B3MA006	
2NC	24V AC/DC	24V AC/DC	B3MA007	
2NC	240V AC	240V AC	B3MA008	



**Serie PM ø 22 mm | PM Series ø 22 mm**  
**Pulsantiere di manutenzione serie LIST 4 fori**  
**Inspection pushbutton stations 4 holes LIST series**

**Pulsante di emergenza monoblocco sblocco a trazione, salita-discesa, consenso e interruttore**  
**Monoblock E-stop push-pull, up-down, common and switch**

	Pulsante emergenza E-stop	Salita Up	Discesa Down	Consenso Common	Interruttore Switch	Codice Code	Dimensioni Dimension mm
	1NC	1NO	1NO	1NC+1NO	2NC+2NO	B4MA001	Vedi pag. 52 See page 52

**Pulsante di emergenza monoblocco sblocco a trazione, salita-discesa, consenso-allarme e interruttore**  
**Monoblock e-stop push-pull, up-down, common- alarm and switch**

	Pulsante emergenza E-stop	Salita Up	Discesa Down	Consenso Common	Interruttore Switch	Codice Code	Dimensioni Dimension mm
	1NC	1NO	1NO	1NO	2NC+2NO	B4MA002	Vedi pag. 52 See page 52

**Pulsante di emergenza monoblocco sblocco a trazione, salita, discesa e interruttore**  
**Monoblock e-stop push-pull, up, down and switch**

	Pulsante emergenza E-stop	Salita Up	Discesa Down	Interruttore Switch	Codice Code	Dimensioni Dimension mm
	2NC	2NO	2NO	3NC+1NO	B4MA003	Vedi pag. 52 See page 52

## Serie PM ø 22 mm | PM Series ø 22 mm

### Pulsantiera di manutenzione serie LIST 5 fori

### Inspection pushbutton stations 5 holes LIST series

#### Pulsante di emergenza monoblocco sblocco a rotazione, interruttore, salita, consenso e discesa

#### Monoblock E-stop twist to release, switch, up, common and down

	Pulsante emergenza E-stop	Interruttore Switch	Salita Up	Consenso Common	Discesa Down	Codice Code	Dimensioni Dimension mm
	2NC	3NC+1NO	2NO	1NC+1NO	2NO	B5MA001	Vedi pag. 52 See page 52

#### Pulsante di emergenza monoblocco sblocco a rotazione, interruttore, salita-discesa, consenso-allarme e LED 10 lumen intermitt.

#### Monoblock E-stop twist to release, switch, up-down, common-alarm and LED 10 lumen intermitt.

	Pulsante emergenza E-stop	Interruttore Switch	Salita Up	Discesa Down	Consenso Common	Codice Code	Dimensioni Dimension mm
	2NC	3NC+1NO	2NO	2NO	1NO	B5MA002	Vedi pag. 52 See page 52

#### Pulsante di emergenza sblocco a trazione visivo, interruttore, salita, consenso e discesa

#### E-stop push-pull vision, switch, up, common and down

	Pulsante emergenza E-stop	Interruttore Switch	Salita Up	Consenso Common	Discesa Down	Codice Code	Dimensioni Dimension mm
	2NC	2NC+2NO	2NO	1NC+1NO	2NO	B50A001	Vedi pag. 52 See page 52

#### Pulsante di emergenza monoblocco sblocco a rotazione, interruttore, salita-discesa, consenso-allarme e chiudi porta-apri porta

#### Monoblock E-stop twist to release, switch, up-down, common-alarm and door close-door open

	Pulsante emergenza E-stop	Interruttore Switch	Salita Up	Discesa Down	Allarme Alarm	Consenso Common	Chiudi porta Door close	Apri porta Door open	Codice Code	Dimensioni Dimension mm
	2NC	3NC+3NO	2NO	2NO	1NO	1NO	1NO	1NO	B5MA003	Vedi pag. 52 See page 52

# Serie PM $\varnothing$ 22 mm | PM Series $\varnothing$ 22 mm

## Pulsantiere

### Pushbutton stations

Pulsantiere vuote IP65 con fori  $\varnothing$  22,5 mm / IP65 Push button stations with holes  $\varnothing$  22,5 mm

	1 foro / 1 hole	2 fori / 2 holes	3 fori / 3 holes	4 fori / 4 holes	5 fori / 5 holes
●	B1A03	B2A03	B3A03	B4A03	B5A03
●	B1A09	B2A09	B3A09	B4A09	B5A09

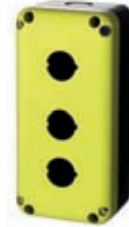

Ogni articolo comprende base, coperchio, viti e guarnizione  
All articles include base, cover, screws and gasket

#### Dimensioni / Dimension mm

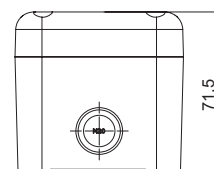
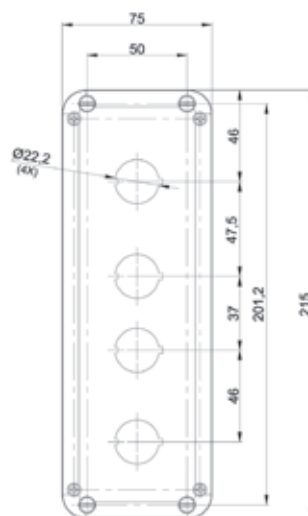
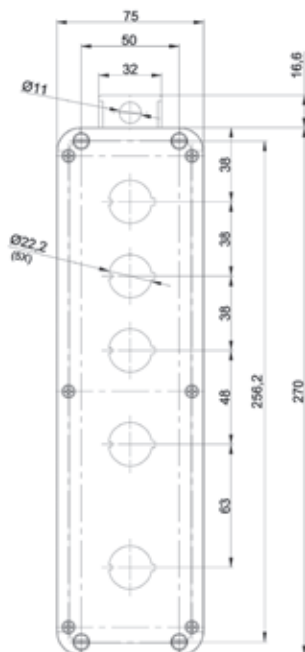
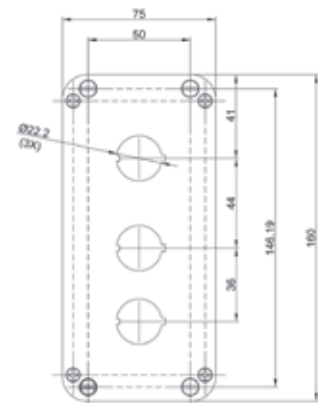
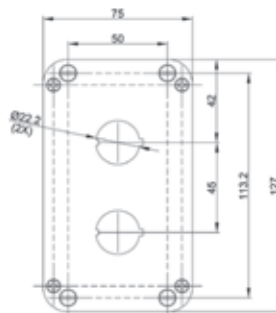
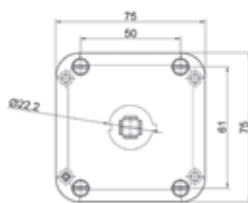

Caratteristiche tecniche / Technical specifications

Pulsantiere 3 fori / 3 holes pushbutton stations

Dimensioni / Dimension mm

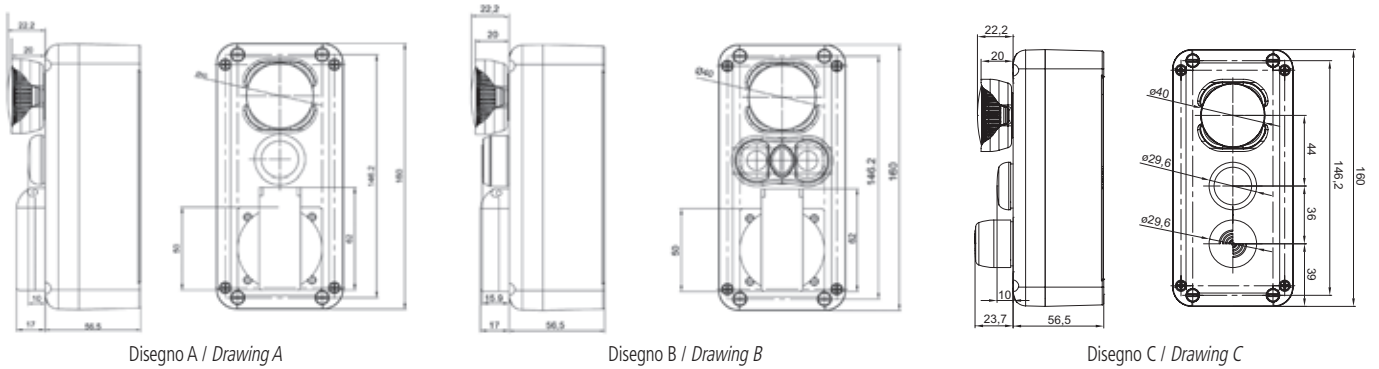

Pulsantiere 4 fori / 4 holes pushbutton stations

Dimensioni / Dimension mm

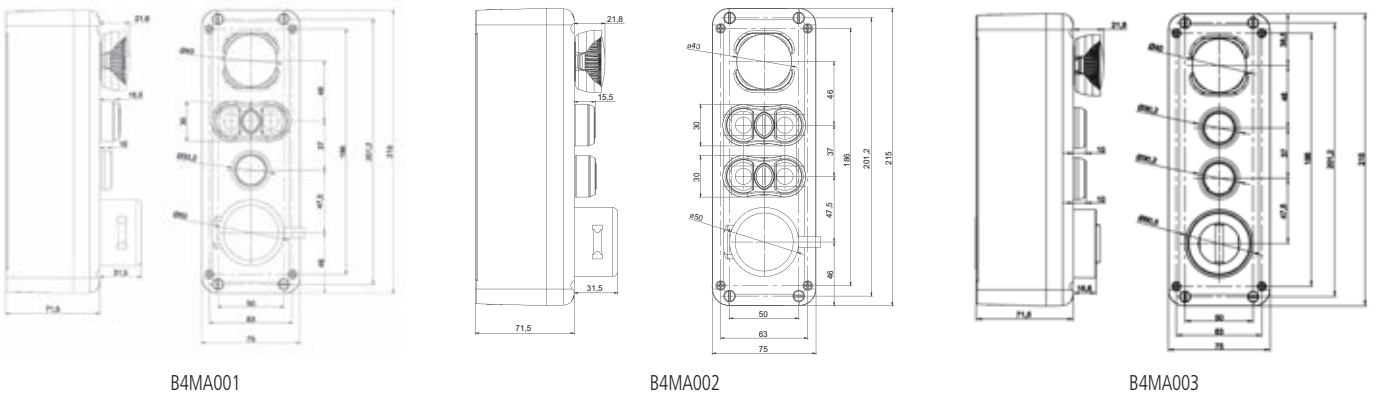

Pulsantiere 5 fori / 5 holes pushbutton stations

Dimensioni / Dimension mm

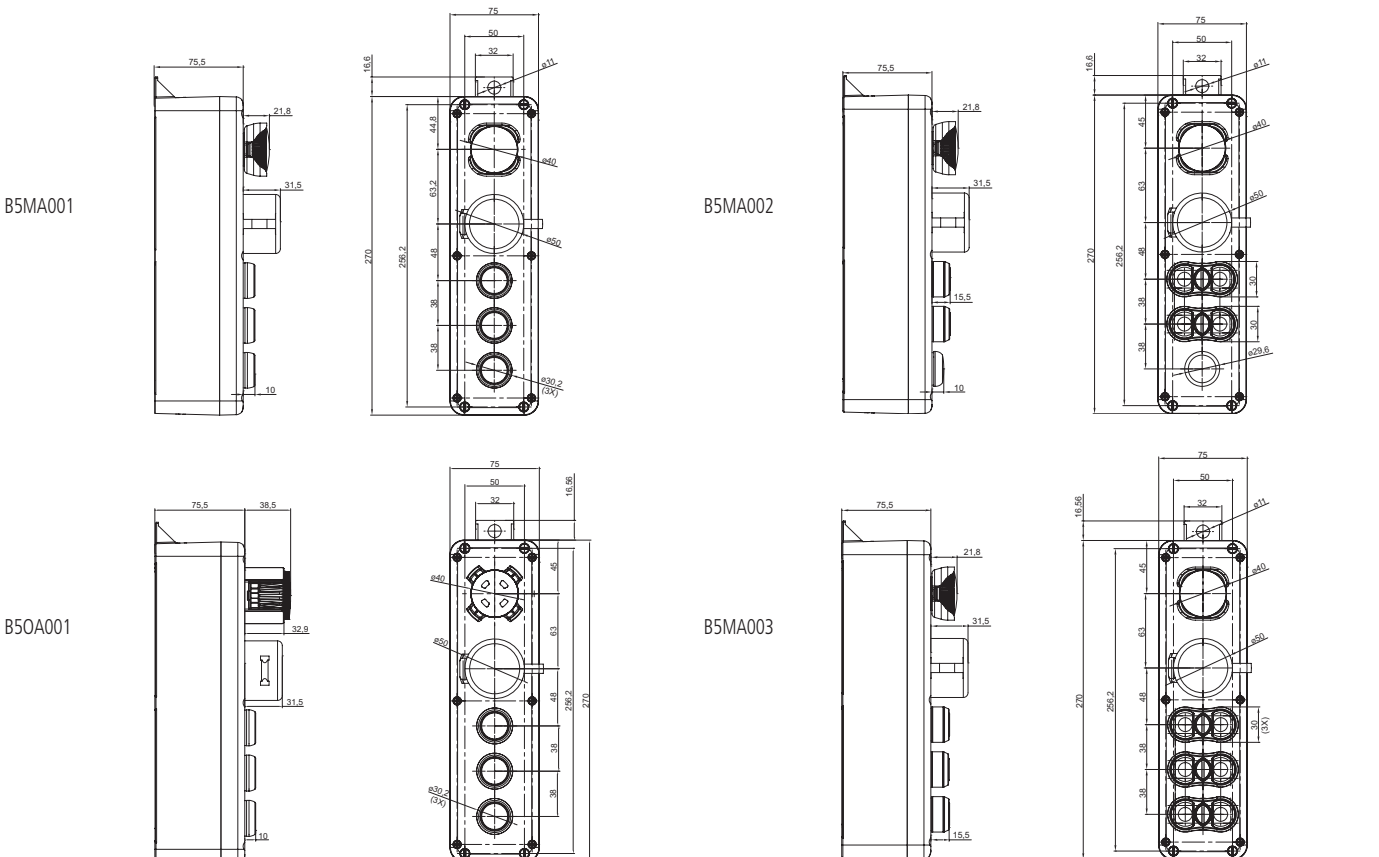

## Caratteristiche tecniche / Technical specifications

### Contatti integrati e modulari / Integral and modular contacts

Categoria Utilizzo / Utilization category	Alimentazione / Supply	IEC-60947-5-1	UL-508	ITH Corrente termica - Thermal current
	AC	AC-15	A600	10A
	DC	DC-13	P300	
Tensione nominale / Rated Voltage	230V AC	120V AC	24V AC	
Corrente nominale / Rated Current	6A	6A	1,5A	
Frequenza d'impiego / Operating Frequency	50-60 Hz			
Durata elettrica / Electrical life	0,5 milioni cicli / 0,5 million cycle			
Test HV per 60 sec. / HV test for 60 sec.	2,5kV (tutti i terminali cortocircuitati) / 2,5kV (all terminals shorted together)			
Tensione di isolamento / Rated insulation voltage	600 VAC			
Terminali / Terminals	Idonei per conduttori rigidi o flessibili da 2x1 mm <sup>2</sup> a 2x2,5 mm <sup>2</sup> Suitable for flexible or solid conductors from 2x1 mm <sup>2</sup> to 2x2,5 mm <sup>2</sup>			
Materiale conduttore / Current carrying material	Ottone / Brass			
Tipo contatto / Contact Type	NA/NC / Make & Break			
Materiale contatto / Contact Material	AgNi			
Forza serraggio nominale / Operating torque	0,8 Nm			
Funzione / Function	Push, passo-passo, premi-gira, Selettore / Push, Push-Push, push-turn, Selector			
Disposizione dei contatti / Disposition of Contact	<input type="checkbox"/> contatto aperto / contact open <input checked="" type="checkbox"/> contatto chiuso / contact close			

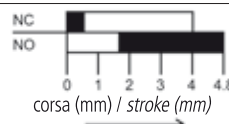

### Dati ambientali / Enviromental rating

Temperatura di esercizio / Operating Temperature	-25°C...65°C
Temperatura di stoccaggio / Storage Temperature	-30°C...70°C
Grado di protezione IP / IP rating	IP65 a pannello / IP 65 above panel Terminali IP20 / IP 20 for terminals
Conformità RoHS / RoHS Compliance	Sì / Yes

### Durata meccanica degli attuatori / Mechanical life for actuators

Instabile / Momentary	1 milione operazioni / 1 million operations
Pulsante di emergenza sblocco a rotazione / E-Stop turn to release	0,1 milione operazioni / 0,1 million operations
Pulsante di emergenza sblocco a trazione / E-Stop push-pull	0,5 milione operazioni / 0,5 million operations
Selettore / Selector	0,5 milione operazioni / 0,5 million operations

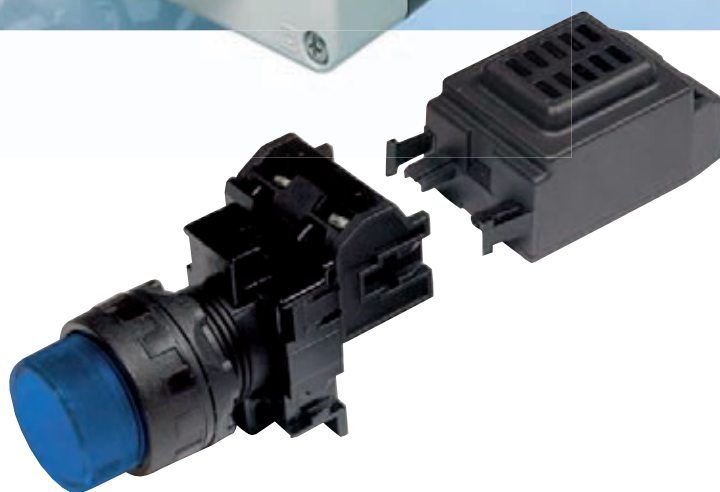

### Serie P - Caratteristiche tecniche generali P series - General technical characteristics

- Fissaggio su foro  $\varnothing$  22 mm  
*Fixing on  $\varnothing$  22 mm hole*
- Per correnti 10A, 12A  
*For currents 10A, 12A*
- Grado di protezione frontale IP65  
*IP65 frontal protection degree*
- Operatori con elemento frontale cromato nero,  $\varnothing$  30 mm e frontale quadrato sono disponibili a richiesta  
*Actuators with black chromed frontal element  $\varnothing$  30 mm and square front are available on request*

## Caratteristiche generali

La gamma di ausiliari di comando e segnalazione ITALWEBER offre molteplici soluzioni d'impiego per il comando e controllo di circuiti elettrici a bassa tensione alimentati in corrente alternata o continua. Gli attuatori sono disponibili con fissaggio diametro 22 e 30 mm, i corpi sono sia metallici che termoplastici e disponibili in versione tonda o quadra. Tutti gli operatori hanno grado di protezione IP65 e sono quindi protetti contro la penetrazione di corpi solidi, polvere e liquidi. La gamma comprende pulsanti stabili ed instabili, luminosi e non, selettori a chiave e a manopola, selettori e segnali luminosi, manipolatori a cloche, pulsanti a fungo e di emergenza, custodie isolanti, comandi potenziometrici, pulsantiere a palmo: una gamma completa in grado di soddisfare ogni esigenza.

### I vantaggi

Il fissaggio dei corpi in termoplastico avviene tramite controgliera per velocizzare al massimo l'operazione, mentre gli attuatori metallici si fissano per mezzo di due viti per garantire la massima tenuta meccanica, per impiego pesante ed in presenza di forti vibrazioni. La nuova linea di pulsantiere termoplastiche include custodie a 1, 2, 3 e 5 posti caratterizzate da grado di protezione IP65 e dalla semplificata installazione che ne permette il cablaggio ad elementi di contatto già montati sul fondo cassetta. Gli elementi di contatto e le alimentazioni sono accoppiabili a scatto e possono essere cablati separatamente dall'operatore, permettendo un'elevata flessibilità e semplificando le operazioni di installazione e manutenzione; inoltre offrono il grado di protezione IP20 contro i contatti accidentali. Sono disponibili sia in versione per montaggio diretto su attuatore che per fondo cassetta, con terminali a vite o innesto. Le caratteristiche costruttive e l'elevato grado di modularità consentono una rapido montaggio ed una notevole flessibilità, con un forte risparmio di tempo durante l'installazione e una riduzione dei costi di magazzino.

### Le certificazioni

L'impiego dei migliori materiali e l'esperienza ITALWEBER nel campo garantiscono l'elevata qualità, l'affidabilità nel tempo e la sicurezza di funzionamento degli ausiliari di comando serie P, il tutto comprovato dai Marchi e Omologazioni concessi dai più importanti Istituti Internazionali.

### La sicurezza

Nei pulsanti d'emergenza l'operatore è stato realizzato per rispondere alle normative IEC/EN 60947-5-5 con particolare riferimento ai requisiti di sicurezza della Direttiva Macchine Europea EN 60418. Infatti, la particolare costruzione del corpo operatore, grazie all'ausilio di un sistema meccanico a molla, garantisce l'apertura positiva del contatto NC ogni qualvolta il sistema di aggancio viene azionato volontariamente prevenendo in questo modo qualsiasi possibile danno a persone o cose.

### Accessori e altri prodotti

La nostra gamma di ausiliari di comando è completata da un'ampia scelta di prodotti per soddisfare ogni esigenza.

## General characteristics

Italweber range of modular control switches and indicating units offers many application solutions on low voltage electrical circuits, both in alternating and direct current. Actuators are available for 22 and 30 mm diameter central hole fixing, bodies are both metal and thermoplastic, round and square version. Protection class for all operators is IP65 which means protection against penetration of solids, dust and liquids. The control switches range includes maintained and momentary pushbuttons, illuminated and non-illuminated version, key and knob handle selector switches, pilot lights, joystick operators, mushroom and emergency stop pushbuttons, insulating enclosures, potentiometric controls, mushroom head control stations: a complete range of products built and designed to satisfy every application need.

### Benefits

Fixing of thermoplastic bodies is done through lock-nuts for make the operation very quick, while the metal actuators can be fixed by means of two screws in order to guarantee the maximum mechanical strength, also for heavy applications and in presence of vibrations. The new thermoplastic control stations product line includes 1, 2, 3 and 5 holes enclosures with IP65 protection class and they are easy to be installed to get simple wiring to contact blocks previously mounted on back panel. Contact blocks and power supplies are lock coupled (snapon system) and can be wired separately from operator to obtain high flexibility and easy installation and maintenance. Ingress protection class is IP20, that avoids accidental finger contact on electrical parts. Italweber contact blocks are available front and base mounting and with screw or fast-on terminals. Manufacturing characteristics together with the high modularity level allow a quick mounting and maximum flexibility, reaching a significant time-saving as far as installing operations and a strong cutting of store expenses.

### Approvals

Carefully selected products materials and Italweber expertise assure optimum quality, long time availability and running security of P Series control switches as confirmed by the number of approvals and homologations obtained by the most important International Institutes.

### Safety

The operator for emergency stop pushbuttons has been realized according to IEC/EN 60947-5-5 international standard and to EN 60418 safety requirements. In fact, the special operator body construction based on a spring weight mechanical system allows the positive opening of NC contact whenever the coupling system is voluntarily driven, so avoiding all eventual damage to persons or things.

### Accessories and further products









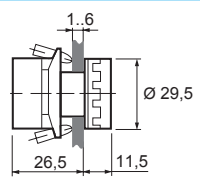

Our range of control switches also covers a wide number of products built to satisfy any application need.

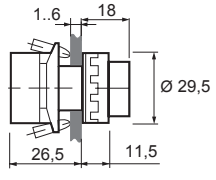

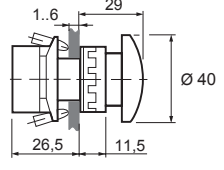

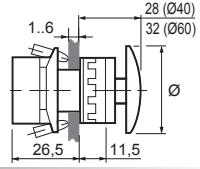

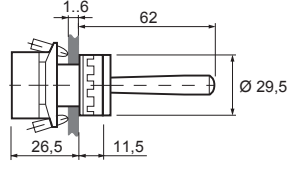
# Serie PR - ø22 mm | PR Series – ø22 mm

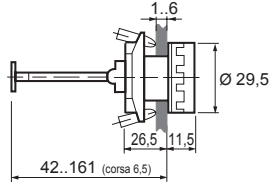
## Pulsanti non luminosi, corpo in metallo, elemento frontale rotondo Non-illuminated pushbutton, metal body, round front element

### Instabili / Momentary

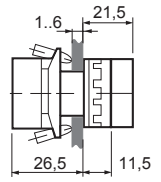
Descrizione / Description	Operatore / Operator	Attuatore / Actuator	Dimensioni mm / Dimensions mm
Bottone rasato / Flush guard 	● ● ○ PR-010M22 ☉	● ATT-804A ● ATT-804G ● ATT-804V	
Bottone sporgente / Extended button 	● PR-020M22R	● ATT-805A ○ ATT-805B ● ATT-805G ● ATT-805N ● ATT-805V	
Fungo assiale / Mushroom head 	● PR-050M22R ● PR-050M22N		
Fungo oscillante / Wobble mushroom head 	● PR-055M22R (ø 40 mm) ● PR-055M22N (ø 40 mm) ● PR-056M22R (ø 60 mm)		
Leva oscillante / Wobble joystick 	● PR-054M22R		
Ripristino / Reset 	Ⓡ PR-255M22A	● ATT-804A ○ ATT-804B ● ATT-804G ● ATT-804N ● ATT-804R ● ATT-804V	senza simboli without symbols 

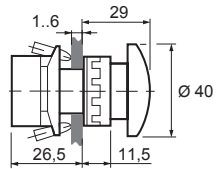
### Stabili / Maintained

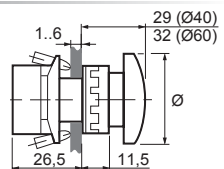
Descrizione / Description	Operatore / Operator	Attuatore / Actuator	Dimensioni mm / Dimensions mm
Bottone rasato passo-passo protetto Flush guard push-on/push-off 	PR-030M22 ☉ Attuatore da ordinarsi separatamente Actuator to be ordered separately	● ATT-728A ○ ATT-728B ● ATT-728G ● ATT-728N ● ATT-728R ● ATT-728V	
Fungo passo-passo / Mushroom head push-on/push-off 	● PR-045M22R ● PR-045M22N		
Fungo sbocco a rotazione / Mushroom head turn to reset 	● PR-065M22R (ø40 mm) ● PR-066M22R (ø60 mm)		







# Serie PR - ø22 mm | PR Series – ø22 mm



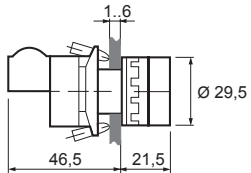

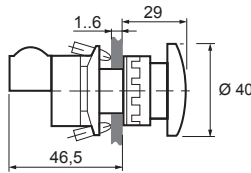
## Pulsanti luminosi, corpo in metallo, elemento frontale rotondo

### Illuminated pushbutton, metal body, round front element

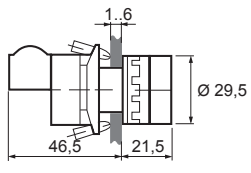

#### Instabili / Momentary

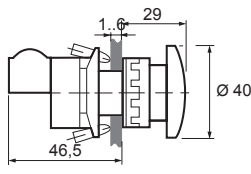
Descrizione / Description	Operatore / Operator	Attuatore / Actuator	Dimensioni mm / Dimensions mm
Bottone rasato protetto / Flush guard 	PR-122M22 Attuatore da ordinarsi separatamente Actuator to be ordered separately	● ATT-814A ● ATT-814G ● ATT-814L ● ATT-814R ● ATT-814T ● ATT-814V	
Bottone sporgente / Extended button 	● PR-120M22R	● ATT-814A ● ATT-814G ● ATT-814L ● ATT-814T ● ATT-814V	
Fungo assiale / Mushroom head 	● PR-150M22R	● ATT-818G ● ATT-818V	
Bottone protetto con collare / Flush with extended collar 	● PR-123M22R ● PR-123M22V ● PR-123M22G ● PR-123M22A		

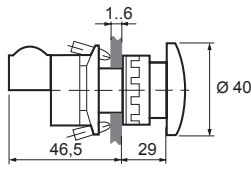
#### Stabili / Maintained

Descrizione / Description	Operatore / Operator	Attuatore / Actuator	Dimensioni mm / Dimensions mm
Bottone rasato passo-passo Flush guard push-on/push-off 	PR-130M22 ③ Attuatore da ordinarsi separatamente Actuator to be ordered separately	● ATT-520A ● ATT-520G ● ATT-520R ● ATT-520T ● ATT-520V	
Fungo passo-passo / Mushroom head push-on/push-off 	● PR-145M22R  Da utilizzare con alimentazione diretta CBS-RD00B9 For use with direct supply CBS-RD00B9	● ATT-521G ● ATT-521V	
Fungo sbocco a rotazione / Mushroom head turn to reset 	PR-165M22R		





① L'operatore PR-010M22 è fornito completo di attuatori rosso, nero e bianco / PR-010M22 is including red, black and white actuators

② Contatti da utilizzare / Contacts:  V10EF10E  V011F01 max 4 contatti / 4 contacts max

③ Contatti da utilizzare / Contacts:  V011F01  V10EF10E max 2 contatti / 2 contacts max

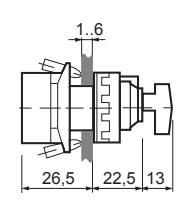
# Serie PR - ø22 mm | PR Series - ø22 mm

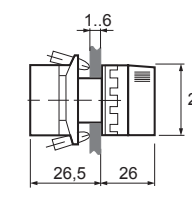
## Selettori luminosi e non luminosi 2, 3 posizioni, corpo metallo, elemento frontale rotondo Illuminated and non-illuminated selectors 2, 3 positions, metal body, round front element

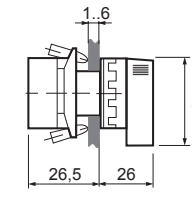
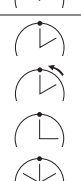
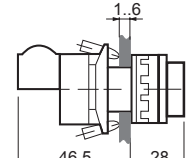
Descrizione / Description	Posizioni / Positions	60°		120°		60°			60°			Dimensioni mm Dimensions mm
		0	1	0	1	1	0	2	1	0	2	
Parte superiore / Top side  Centrale Central  Parte inferiore / Bottom side	V01	X		X		X		X		X	X	X = Contatto chiuso / Closed contact  Chiusure ottenibili innestando nella parte superiore o inferiore i contatti Closures obtained inserting the contacts on the top or bottom
	V10		X		X		X		X	X		
	V01L	X		X		X	X	X	X		X	
	V10E		X		X	X	X	X	X			
	V01	X		X		X		X		X	X	
	V10		X		X		X		X		X	
	V01L	X		X		X	X	X	X	X		
	V10E		X		X	X	X	X	X		X	
Chiave / Key		PR-200M22N PR-201M22N PR-250M22N  PR-204M22N PR-205M22N PR-254M22N  PR-210M22N PR-230M22N PR-270M22N PR-280M22N					PR-213M22N PR-232M22N PR-233M22N  PR-283M22N					
Manopola non luminosi / Non-illuminated knob		PR-300M22N PR-350M22N  PR-304M22N PR-354M22N  PR-310M22N PR-370M22N PR-380M22N				PR-312M22N PR-372M22N	PR-313M22N PR-373M22N PR-383M22N					
Leva non luminosi / Non-illuminated lever		PR-400M22N PR-450M22N  PR-404M22N PR-454M22N  PR-410M22N PR-470M22N PR-480M22N				PR-412M22N PR-472M22N	PR-413M22N PR-473M22N PR-483M22N					
Manopola luminosi ③ Illuminated knob		PR-650M22x PR-655M22x PR-651M22x  PR-653M22x										

① Per ottenere un deviatore unipolare a 3 vie, innestare sulla parte superiore 1NC+1NO e sulla parte inferiore 1NC / For obtain one pole 3 pos. switch, to insert 1NC+1NO on the top and 1NC at the bottom

② Per ottenere un selettore MARCIA-ARRESTO, innestare sulla parte superiore 1NC e sulla parte inferiore 1NO / For obtain START-STOP switch, to insert 1NC on the top and 1NO at the bottom

③ Per l'ordinazione sostituire alla "x" le iniziali del colore / Ordering replace "x" with the color code: (A = blu / blue, B = bianco / white, G = giallo / yellow, R = rosso / red, V = verde / green)





Cifatura standard E1, a richiesta sono disponibili cifrature diverse / Standard inscription E1, other types available on request

▼ Estrazione chiave  
Key extraction



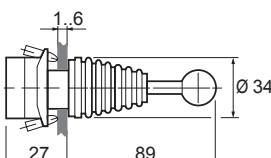

● Posizione di riposo  
Rest position

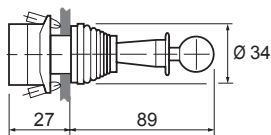
# Serie PR - ø22 mm - Manipolatori 3, 5 posizioni, indicatori luminosi e comando potenziometro, corpo metallo, elemento frontale rotondo

## PR Series - ø22 mm - Joystick operators 3, 5 positions, pilot lights, potentiometric control, metal body, round front element

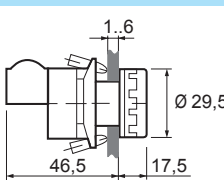
Descrizione / Description	Posizioni / Positions	90°			90°				Dimensioni mm Dimensions mm
		2	0	1	3	2	0	1	
Parte superiore / Top side 	V01			X			X		X = Contatto chiuso / Closed contact  Chiusure ottenibili innestando nella parte superiore o inferiore i contatti Closures obtained inserting the contacts on the top or bottom
	V10	X				X			
	V10E	X	X		X	X	X	X	
	V01	X			X				
	V10			X				X	
	V10E		X	X		X	X	X	
Parte inferiore / Bottom side 	V01			X					
	V10			X				X	
	V10E		X	X		X	X	X	
	V10E		X	X		X	X	X	
Manipolatore a leva senza blocco ① Joystick without block 	2 . 1	PR-530M22NM							
	2 → · 1	PR-531M22NM							
	3 2 . 1 4				PR-550M22NM				
	3 2 → · 1 4				PR-551M22NM				
Manipolatore a leva con blocco in posizione "0" ① Joystick with mechanical latch in "0" position 	2 . 1	PR-570M22NM							
	2 → · 1	PR-571M22NM							
	3 2 . 1 4				PR-580M22NM				
	3 2 → · 1 4				PR-581M22NM				

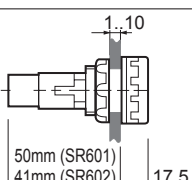
① Forniti completi di targhetta / Supplied complete with legend plate

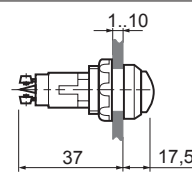









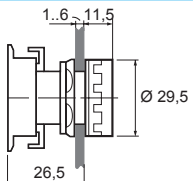

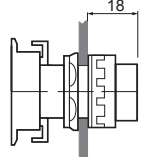
Descrizione / Description	Operatore / Operator	Attuatore / Actuator	Dimensioni mm Dimensions mm
Indicatore luminoso per alimentazioni aggiuntive Pilot light for additional power supplies 	PR-600M22 (BA 9s)  Gemma da ordinare separatamente Lens to be ordered separately	<ul style="list-style-type: none"> <li><span style="color: blue;">●</span> ATT-821A</li> <li><span style="color: yellow;">●</span> ATT-821G</li> <li><span style="color: orange;">●</span> ATT-821L</li> <li><span style="color: red;">●</span> ATT-821R</li> <li><span style="color: grey;">●</span> ATT-821T</li> <li><span style="color: green;">●</span> ATT-821V</li> </ul>	
Indicatore luminoso monolitico in termoplastico Thermoplastic monolithic pilot light 	PR-601T22 (BA 9s) PR-602T22 (E10)  Gemma da ordinare separatamente Lens to be ordered separately	<ul style="list-style-type: none"> <li><span style="color: blue;">●</span> ATT-821A</li> <li><span style="color: yellow;">●</span> ATT-821G</li> <li><span style="color: orange;">●</span> ATT-821L</li> <li><span style="color: red;">●</span> ATT-821R</li> <li><span style="color: grey;">●</span> ATT-821T</li> <li><span style="color: green;">●</span> ATT-821V</li> </ul>	
Indicatore luminoso monolitico in termoplastico Thermoplastic monolithic pilot light 	PR-T22BA9S (BA 9s) PR-T22E10 (E10)  Gemma da ordinare separatamente Lens to be ordered separately	<ul style="list-style-type: none"> <li><span style="color: blue;">●</span> ATT-821A</li> <li><span style="color: white;">○</span> ATT-821B</li> <li><span style="color: yellow;">●</span> ATT-821G</li> <li><span style="color: red;">●</span> ATT-821R</li> <li><span style="color: green;">●</span> ATT-821V</li> </ul>	

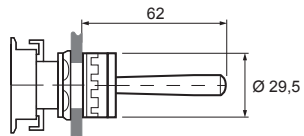
# Serie PR - ø22 mm | PR Series – ø22 mm

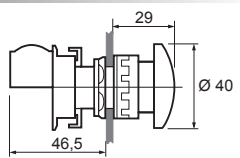
## Pulsanti luminosi e non luminosi, corpo in termoplastico

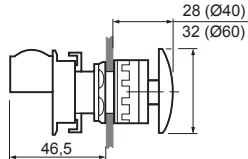
### Illuminated and non-illuminated pushbutton, thermoplastic body

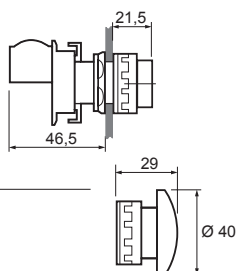

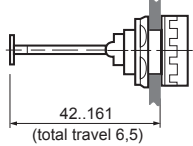

#### Pulsanti instabili, elemento frontale rotondo o quadrato / Momentary pushbutton, round or square front element

Descrizione / Description	Operatore / Operator	Attuatore / Actuator	Dimensioni mm / Dimensions mm
<p>Bottone rasato / Flush guard</p> 	<p>PR-010T22 Attuatore da ordinare separatamente Actuator to be ordered separately</p>	<ul style="list-style-type: none"> <li><span style="color: blue;">●</span> ATT-804A</li> <li><span style="color: white;">○</span> ATT-804B</li> <li><span style="color: yellow;">●</span> ATT-804G</li> <li><span style="color: black;">●</span> ATT-804N</li> <li><span style="color: red;">●</span> ATT-804R</li> <li><span style="color: green;">●</span> ATT-804V</li> </ul>	
<p>Bottone sporgente / Extended button</p> <p>Bottone rasato con collare di protezione Flush guard with extended collar</p> 	<p>PR-015T22 Attuatore da ordinare separatamente Actuator to be ordered separately</p>	<ul style="list-style-type: none"> <li><span style="color: blue;">●</span> ATT-805A</li> <li><span style="color: white;">○</span> ATT-805B</li> <li><span style="color: yellow;">●</span> ATT-805G</li> <li><span style="color: black;">●</span> ATT-805N</li> <li><span style="color: red;">●</span> ATT-805R</li> <li><span style="color: green;">●</span> ATT-805V</li> </ul>	
<p>Leva oscillante / Wobble joystick</p> 	<p><span style="color: red;">●</span> PR-054T22R</p>		
<p>Fungo assiale / Mushroom head</p> 	<p><span style="color: red;">●</span> PR-050T22R</p>		
<p>Fungo oscillante / Wobble mushroom head</p> 	<p><span style="color: red;">●</span> PR-055T22R ø40 mm <span style="color: red;">●</span> PR-056T22R ø60 mm</p>		
<p>Pulsante luminoso / Illuminated pushbutton</p>  <p>Bottone sporgente Extended button</p> <p>Fungo Mushroom head</p>	<p>PR-120T22 Attuatore da ordinare separatamente Actuator to be ordered separately</p>	<ul style="list-style-type: none"> <li><span style="color: blue;">●</span> ATT-814A</li> <li><span style="color: yellow;">●</span> ATT-814G</li> <li><span style="color: orange;">●</span> ATT-814L</li> <li><span style="color: red;">●</span> ATT-814R</li> <li><span style="color: grey;">●</span> ATT-814T</li> <li><span style="color: green;">●</span> ATT-814V</li> </ul>	
<p>Ripristino / Reset</p> 	<p><span style="color: blue;">Ⓡ</span> PR-556T22</p>	<ul style="list-style-type: none"> <li><span style="color: blue;">●</span> ATT-804A</li> <li><span style="color: white;">○</span> ATT-804B</li> <li><span style="color: yellow;">●</span> ATT-804G</li> <li><span style="color: black;">●</span> ATT-804N</li> <li><span style="color: red;">●</span> ATT-804R</li> <li><span style="color: green;">●</span> ATT-804V</li> </ul>	<p>senza simboli without symbols</p> 

## Serie PR - ø22 mm | PR Series - ø22 mm

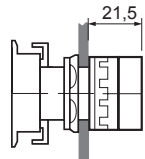

Pulsanti non luminosi, indicatori luminosi e comando potenziometro, corpo in termoplastico  
*Non-illuminated pushbutton, illuminated indicators and potentiometric control, plastic body*

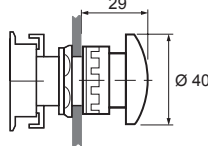
### Pulsanti stabili, elemento frontale rotondo / Maintained pushbutton, round front element





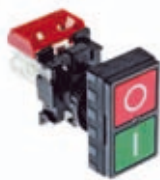

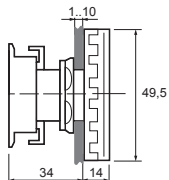

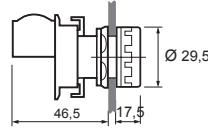

Descrizione / Description	Operatore / Operator	Attuatore / Actuator	Dimensioni mm / Dimensions mm
Bottone rasato passo-passo protetto <i>Flush guard push-on/push-off</i> 	PR-030T22 ⊕ Attuatore da ordinare separatamente <i>Actuator to be ordered separately</i>	 ATT-728A ATT-728B ATT-728G ATT-728N ATT-728R ATT-728V	
Fungo passo-passo / Mushroom head <i>push-on/push-off</i> 	 PR-045T22R ⊕ PR-045T22N ⊕		

⊕ Contatti da utilizzare / Contacts:  V10EVF10E  V011F01 max 4 contatti / 4 contacts max

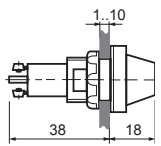
### Pulsante multifunzione / Multifunction pushbutton

Descrizione / Description	Operatore / Operator	Dimensioni mm / Dimensions mm
	 PQ-011T22 PQ-011T22A PQ-011T2	
IP40	Per versione luminosa aggiungere alimentazione diretta CBS-RDB9 <i>Direct supply to obtain warning light CBS-RDB9</i>	

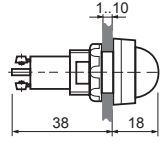
### Indicatori luminosi e comando potenziometro / Illuminated indicators and potentiometric control

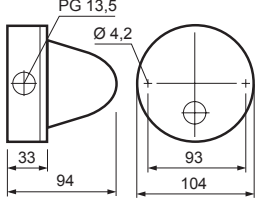
Descrizione / Description	Operatore / Operator	Gemma / Lens	Dimensioni mm / Dimensions mm
Indicatore luminoso per alimentazioni aggiuntive <i>Indicator light for additional power supplies</i> 	PR-600T22  Gemma da ordinare separatamente <i>Lens to be ordered separately</i>	 ATT-821A ATT-821G ATT-821L ATT-821R ATT-821T ATT-821V	
Monolitico ø16 mm <i>Monolithic ø16 mm</i> 	PR-T16BA9S (BA 9s)  Gemma da ordinare separatamente <i>Lens to be ordered separately</i>	 ATT-493A ATT-493B ATT-493G ATT-493R ATT-493V	
 IP65   IP65	PR-T16E10 (E10)  Gemma da ordinare separatamente <i>Lens to be ordered separately</i>	 ATT-827A ATT-827B ATT-827G ATT-827R ATT-827V	
Jumbo 	Potenza nominale d'impiego $P_e$ (temperatura ambiente 55°): <i>Rated operating power <math>P_e</math>            (ambient temperature 55°):</i> • 15 W continuativi / continuous • 25 W intermittenti / intermittent (ON/OFF 16,6%)	 PR-541T104G (E14) PR-541T104R (E14) PR-541T104V (E14) PR-541T104L (E14) PR-541T104A (E14) PR-541T104B (E14) PR-541T104T (E14)	

# Serie PR - ø22 mm | PR Series - ø22 mm

## Selettori non luminosi 2, 3 posizioni, corpo in termoplastico

### Non-illuminated selectors 2, 3 positions, thermoplastic body

Descrizione / Description	Posizioni / Positions	60°		120°		60°		60°		60°		Dimensioni mm Dimensions mm			
		0	1	0	1	1	0	2	1	0	2				
Parte superiore / Top side  Centrale Central  Parte inferiore / Bottom side		V01	X		X		X		X		X	X	X = Contatto chiuso / Closed contact  Chiusure ottenibili innestando nella parte superiore o inferiore i contatti Closures obtained inserting the contacts on the top or bottom		
		V10		X		X		X		X	X				
		V01L	X		X		X	X	X	X		X		X	
		V10E		X		X		X	X	X	X				
		V01	X		X		X		X		X	X			
		V10		X		X		X		X		X			
		V01L	X		X		X	X	X	X	X	X			
		V10E		X		X		X	X	X		X			
Chiave / Key  		PR-200T22N													
		PR-201T22N													
		PR-250T22N													
		PR-204T22N													
		PR-205T22N													
		PR-254T22N													
		PR-210T22N									PR-213T22N				
		PR-230T22N							PR-232T22N <sup>①</sup>		PR-233T22N				
		PR-270T22N													
		PR-280T22N									PR-283T22N				
		Manopola / Knob  		PR-300T22N											
				PR-350T22N											
PR-304T22N															
PR-354T22N															
PR-310T22N									PR-312T22N <sup>①</sup>		PR-313T22N				
PR-370T22N									PR-372T22N		PR-373T22N				
PR-380T22N											PR-383T22N <sup>②</sup>				
Leva / Lever  				PR-400T22N											
		PR-450T22N													
		PR-404T22N													
		PR-454T22N													
		PR-410T22N							PR-412T22N <sup>①</sup>		PR-413T22N				
		PR-470T22N							PR-472T22N		PR-473T22N				
		PR-480T22N									PR-483T22N <sup>②</sup>				

① Per ottenere un deviatore unipolare a 3 vie, innestare sulla parte superiore 1NC+1NO e sulla parte inferiore 1NC / For obtain one pole 3 pos. switch, to insert 1NC+1NO on the top and 1NC at the bottom  
 ② Per ottenere un selettore MARCIA-ARRESTO, innestare sulla parte superiore 1NC e sulla parte inferiore 1NO / For obtain START-STOP switch, to insert 1NC on the top and 1NO at the bottom  
 Cifratura standard E1, a richiesta sono disponibili cifrature diverse / Standard incryption E1, other types available on request







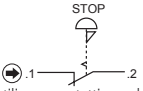
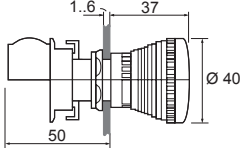

▼ Estrazione chiave  
Key extraction  
● Posizione di riposo  
Rest position

# Serie PR - ø22 mm | PR Series – ø22 mm

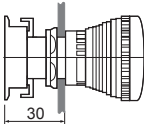
## Pulsanti di emergenza

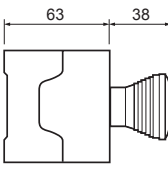
### Emergency pushbutton

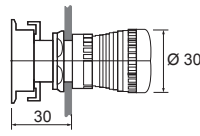
#### Pulsanti di emergenza con sblocco a rotazione e a chiave / Emergency pushbutton turn to release and key

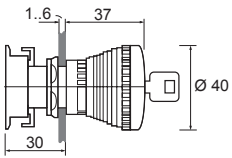
Descrizione / Description	Operatore / Operator	Dimensioni mm / Dimensions mm
ø40 mm + 1NC 	PE-065T22RNC ① Completo di contatto 1NC / 1NC terminal included  (se necessario contatto NO utilizzare contatti con chiusura anticipata V10E\F10E) (if it is necessary NO contact, to use with early make contacts V10E\F10E)	
ø40 mm 	PE-065T22R ① Senza elemento di contatto / Without contact element (se necessario contatto NO utilizzare contatti con chiusura anticipata V10E\F10E) (if it is necessary NO contact, to use with early make contacts V10E\F10E)	
in custodia / in enclosure 	PA-065R-M (Pressacavi / Cableglands M16/20) PA-065R-PG (Pressacavi / Cableglands Pg11/16) (se necessario contatto NO fissaggio su fondo utilizzare contatti con chiusura anticipata B10E) (if it is necessary NO base mounting contact, to use with early make contact B10E)	
ø30 mm 	PE-064T22R (se necessario contatto NO utilizzare contatti con chiusura anticipata V10E\F10E) (if it is necessary NO contact, to use with early make contacts V10E\F10E)	
ø40 mm con sblocco a chiave / ø40 mm key release 	PE-075T22R (se necessario contatto NO utilizzare contatti con chiusura anticipata V10E\F10E) (if it is necessary NO contact, to use with early make contacts V10E\F10E)	

① Tipo di contatti utilizzati per entrambi le versioni / Contact used for both versions: V01 U<sub>e</sub> max 600 V; I<sub>e</sub> max 10A - AC15

Conformi alla direttiva macchine EN-60418 / According to machinery standards EN-60418

#### Elemento frontale rotondo per montaggio su guida DIN / Round front element for DIN rail fixing

Composizione / Composition

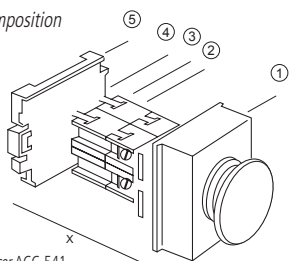

- ① Targhetta / Plate
- ② Distanziatore / Spacer ACC-541
- ③ Supporto / Support ACC-538
- ④ Distanziatore / Spacer ACC-539 o ACC-540
- ⑤ Piastra per guida DIN / DIN rail plate ACC-535

Per ottenere un ausiliario di comando o segnalazione per montaggi su guide DIN 46277/3 di profondità X, ordinare i seguenti codici:  
 For obtain control switches for DIN rail 46277/3 fixing with depth X, to request for the following codes:

Operatore / Operator	X = mm							
	45		58		70			
Operatore / Operator	1	1	1	1	1	1	1	1
Numero di contatti / Contacts number	1	2	1	1	1	2	3	4
Numero di distanziatori / Spacers number	tipo / type ACC-539 (h = 12,5 mm)	-	-	1	1	-	-	-
	tipo / type ACC-540 (h = 5 mm)	-	-	-	-	1	1	1
	tipo / type ACC-541 (h = 20 mm)	1	-	1	-	3	2	1
Supporto per montaggio del contatto / Support for contact mounting ACC-538	1	1	1	1	1	1	1	1
Piastra di montaggio per guida DIN / Fixing plate for DIN rail ACC-535	1	1	1	1	1	1	1	1
Targhetta frontale (vedi sotto) / Front plate (see below)	1	1	1	1	1	1	1	1

Targhetta frontale / Front plate

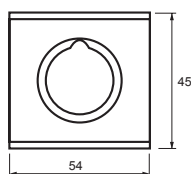

Codice / Code  
 ACC-420  
 ACC-141  
 ACC-142

60° 60°  
 0  
 Trasparente / Transparent  
 0 1  
 2 0 1

Codice / Code  
 ACC-143  
 ACC-144  
 ACC-145











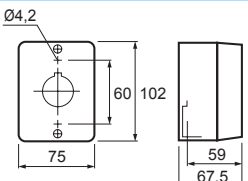

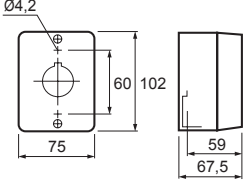

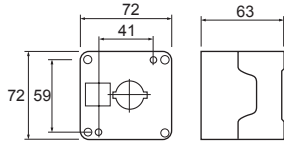
60° 60°  
 0  
 1  
 OFF  
 0 2  
 ON  
 1

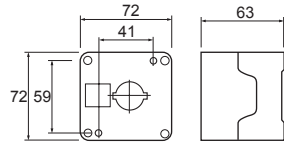
# Custodie isolanti a doppio isolamento, senza pulsanti

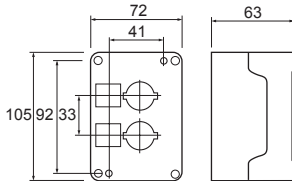
## 1, 2, 3, 5 fori $\varnothing 22\text{mm}$ , $\varnothing 30\text{ mm}$

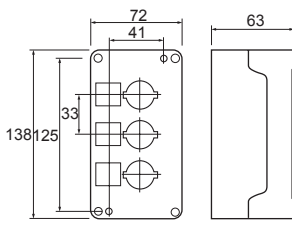
### Insulated enclosures, double insulation, without pushbutton

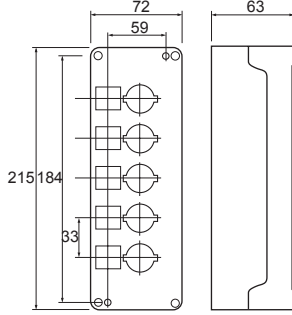
#### 1, 2, 3, 5 holes $\varnothing 22\text{ mm}$ , $\varnothing 30\text{ mm}$

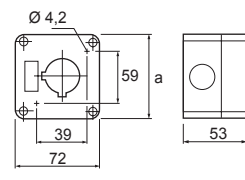
Descrizione / Description	$\varnothing 22\text{ mm}$	Pressacavi / Cableglands	$\varnothing 30\text{ mm}$	Pressacavi / Cableglands	Dimensioni mm / Dimensions mm
1 foro / 1 hole  IP54	● PC22-1Y-PG	Pg 13,5	● PC30-1Y-PG	Pg 13,5	
1 foro / 1 hole  IP54	● PC22-1G-PG	Pg 13,5	● PC30-1G-PG	Pg 13,5	
1 foro / 1 hole ②  IP65	● PA22-1Y-M ● PA22-1Y-PG	M 16/20 Pg 11/16			
1 foro / 1 hole ②  IP65	● PA22-1G-M ● PA22-1G-PG	M 16/20 Pg 11/16			
2 fori / 2 holes ②  IP65	● PA22-2G-M ● PA22-2G-PG	M 16/20 Pg 11/16			
3 fori / 3 holes ②  IP65	● PA22-3G-M ● PA22-3G-PG	M 16/20 Pg 11/16			
5 fori / 5 holes ②  IP65	● PA22-5G-M ● PA22-5G-PG	M 20/25 Pg 16/21			
1 foro / 1 hole 2 fori / 2 holes 3 fori / 2 holes ①  IP65	● PB22-1Y-PG (a = 72) ● PB22-1G-PG (a = 72) ● PB22-2G-PG (a = 105) ● PB22-3G-PG (a = 138)	Pg 13,5 Pg 13,5 Pg 13,5 Pg 13,5	● PB30-1G-PG (a = 72)	Pg 13,5	

Disponibile a richiesta per tutte le custodie PA morsetto di terra e di neutro (codice ACC-817) / Earth and neutral terminals for PA enclosures are available on request (code ACC-817)













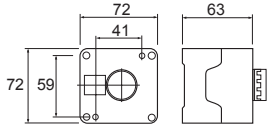



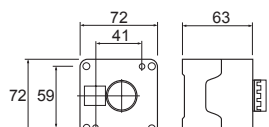



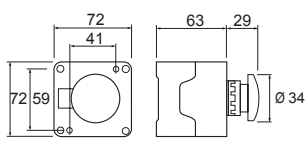



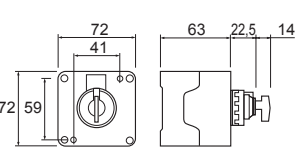

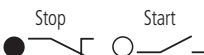
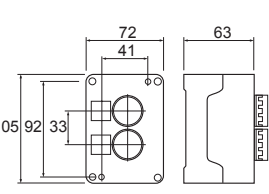
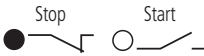
① Per montaggio su fondo cassetta ordinare anche placchetta di aggancio ACC-461 / For bottom mounting to order also fixing plate code ACC-461

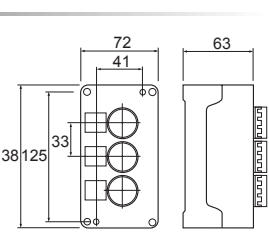
② Per montaggio operatori metallici in custodie PA utilizzare ACC-823 / For metal operators mounting in PA enclosures to adopt code ACC-823

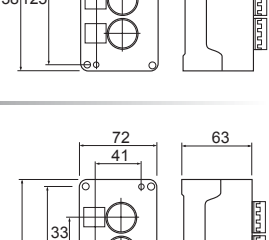

# Custodie isolanti a doppio isolamento con pulsanti

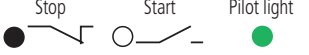
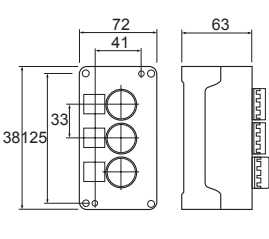
## Insulated enclosures, double insulation with pushbuttons

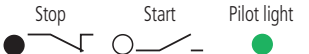
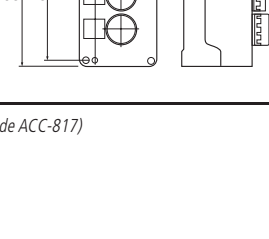
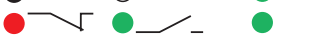
Descrizione / Description	Contatti / Terminals	Operatore / Operator	Pressacavi / Cableglands	Dimensioni mm / Dimensions mm
Bottone rasato / Flush guard 	Start 	PA-81N-M ①	M 16/20	
	Start 	PA-81R-M ①	M 16/20	
Bottone rasato / Flush guard 	Start 	PA-81B-M ①	M 16/20	
	Start 	PA-81V-M ①	M 16/20	
Fungo oscillante / Wobble mushroom 	Stop 	PA-85R-M ①	M 16/20	
	Stop 	PA-85R-PG	Pg 11/16	
Selettore a chiave / Key selector 	0 - 1 	PA-200N-M ①	M 16/20	
	0 - 1 	PA-200N-PG	Pg 11/16	
Bottoni rasati / Flush guards 	Stop Start 	PA-82-M ①	M 16/20	
	Stop Start 	PA-82A-M ①	M 16/20	
Bottoni rasati / Flush guards 	Indietro Stop Avanti 	PA-83-M ①	M 16/20	
	Indietro Stop Avanti 	PA-83A-M ①	M 16/20	
Bottoni rasati e indicatore luminoso Flush guards and pilot light 	Indietro Stop Avanti 	PA-83-PG	Pg 11/16	
	Indietro Stop Avanti 	PA-83A-PG	Pg 11/16	
Bottoni rasati e indicatore luminoso Flush guards and pilot light 	Stop Start Pilot light 	PA-87-M ①	M 16/20	
	Stop Start Pilot light 	PA-87A-M ①	M 16/20	
Bottoni rasati e indicatore luminoso Flush guards and pilot light 	Stop Start Pilot light 	PA-87B-M ①	M 16/20	
	Stop Start Pilot light 	PA-87A-PG	Pg 11/16	

Disponibile a richiesta per tutte le custodie PA morsetto di terra e di neutro (codice ACC-817) / Earth and neutral terminals for PA enclosures are available on request (code ACC-817)







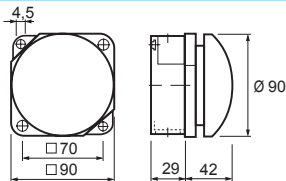

① Pressacavi M20 accettano il montaggio anche dei pressacavi Pg 13,5 / Holes for M20 cableglands accept also Pg 13,5 cableglands

② Come PA-83A-M/PG ma con targhetta "forward-stop-reverse" / Same like PA-83A-M/PG but with plate "forward-stop-reverse"

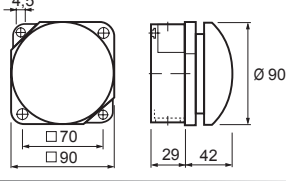
# Serie PF | PF Series

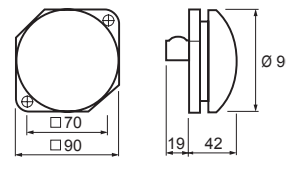
## Pulsanti in termoplastico e in metallo, 10A - 380V

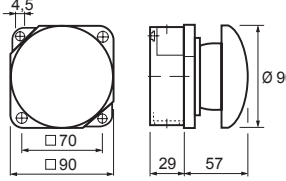

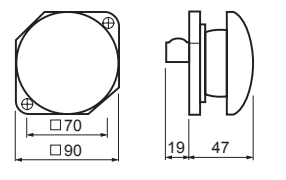
### Plastic and metal pushbuttons, 10A - 380V

Descrizione / Description	Operatore / Operator	Dimensioni mm / Dimensions mm
Fungo assiale rosso Red mushroom	● PF-090TR ① 	
Fungo assiale nero Black mushroom	● PF-090TN ① 	
Fungo assiale da incasso rosso Flush-mounting red mushroom	● PF-091TR ● PF-091TN 	
Fungo oscillante rosso Red wobble mushroom	● PF-190TR ① 	
Fungo oscillante da incasso rosso Flush-mounting red wobble mushroom	● PF-191TR 	

Su richiesta sono fornibili anche in versione luminosa / Illuminated version available on request

① Predisposto per pressacavo Pg 13,5 (codice ACC-519) o passacavi ø21 mm (codice ACC-695) / Prepared for Pg 13,5 cableglands (code ACC-519) or ø21 mm cableglands (code ACC-695)

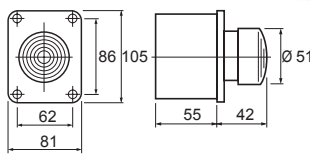
### Pulsantiere metalliche IP65 / IP65 metal pushbuttons

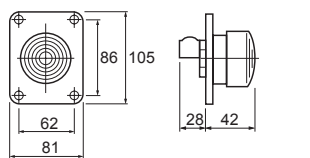
Descrizione / Description	Operatore / Operator	Dimensioni mm / Dimensions mm
Fungo assiale Red mushroom	● PF-090MR ② 	
Fungo assiale da incasso Flush-mounting red mushroom	● PF-091MR 	

DISPONIBILI  
SU RICHIESTA  
AVAILABLE  
ON REQUEST

② Fornito con passacavi ø21 mm (codice ACC-695) e predisposto per pressacavi Pg 13,5 (codice ACC-519) / Supplied with cableglands ø21 mm (code ACC-695) and prepared for Pg 13,5 cableglands (code ACC-519)

### Elementi di contatto / Contact blocks

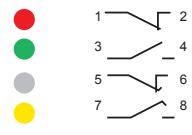
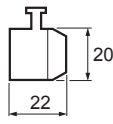
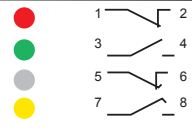
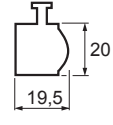
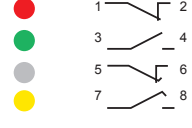
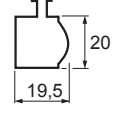
Descrizione / Description	Schema / Scheme	Funzione / Function	Codice / Code	Dimensioni mm / Dimensions mm
Terminali a vite Screw terminals  IP20		1NC 1NO 1NC apertura ritardata / late break 1NO chiusura anticipata / early make	V01 V10 V01L V10E	
Terminali a vite, montaggio fondo cassetta per custodia PA Screw terminals, bottom mounting for PA enclosures		1NC 1NO 1NC apertura ritardata / late break 1NO chiusura anticipata / early make	B01 B10 B01L B10E	
Terminali a innesto Fast-on terminals		1NC 1NO 1NC apertura ritardata / late break 1NO chiusura anticipata / early make	F01 F10 F01L F10E	

### Alimentazioni / Power suppliers

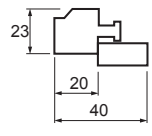
Descrizione / Description	Tensioni / Voltages	Lampadine / Lamps	Codice / Code	Dimensioni mm / Dimensions mm
Diretta / Direct  IP20	Per il fissaggio sul fondo delle cassette / For bottom mounting		CBS-RBB9	
	Per la trasformazione in versione luminosa del pulsante multifunzione PQ-11 For the transformation of the multi-function button PQ-11		CBS-RDB9	

Trasformatore, resistore, resistore con diodo e lampeggiatore, disponibili su richiesta / Transformer, resistor, resistor with diode and flasher, available on request

### Pulsanti di prova / Test buttons

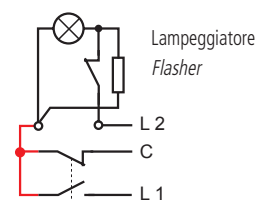
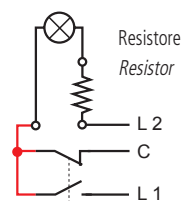
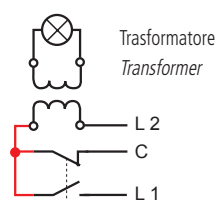
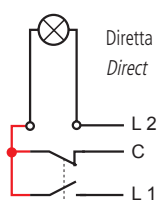

Le connessioni indicate sugli schemi (in rosso) sono da eseguire in relazione ai vari tipi di alimentazione  
The connections shown on the schemes (red colour) must be done in relation to the various types of power supply







# Serie P ø22 mm | P Series ø22 mm

## Accessori Accessories

Descrizione / Description	Volt / Watt	Codice / Code	Descrizione / Description	Volt / Watt	Codice / Code
BA 9s a incandescenza Incandescent BA 9s	6V - 1,2W	ACC-BA9S6V	BA 9s al neon Neon BA 9s	220V	ACC-BA9S220V
	24V - 2W	ACC-BA9S24V			
	36V - 2W	ACC-BA9S36V			
	48V - 1,2W	ACC-BA9S48V			
	130V - 2W	ACC-BA9S130V			
E10 a incandescenza Incandescent E10	24V - 3W	ACC-E10/24V	E10 al neon Neon E10	220V	ACC-E10/220V

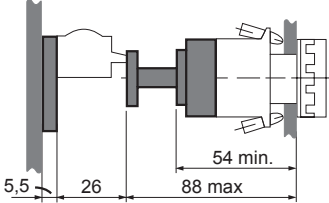
Descrizione / Description	Volt / Watt	Codice / Code	Volt / Watt	Codice / Code	Volt / Watt	Codice / Code
BA 9s LED	240Vac - 0,6W	ACC-LED240V	120Vac - 0,6W	ACC-LED120V	24Vac/DC - 0,5W	ACC-LED24V
		ACC-LED240R		ACC-LED120R		ACC-LED24R
		ACC-LED240M		ACC-LED120M		ACC-LED24M
		ACC-LED240A		ACC-LED120A		ACC-LED24A
		ACC-LED240B		ACC-LED120B		ACC-LED24B

### Varie / Various

	Descrizione / Description	Codice / Code
	Cappuccio di protezione / Protection cap	PR-010M22 / PR-010T22
		● ATT-482N ● ATT-482R ● ATT-4820 ● ATT-482V
		PR-010M30
		● ATT-483N ● ATT-483R ● ATT-4830
		PQ-010M22 / PQ-010T22 PQ-011T22
	■ ATT-280 ■ ATT-293	
	Estrattore lampadine BA 9s / E10 / Bulb extractor BA 9s / E10	ACC-734
	Piastra di rinforzo per operatori metallici in custodie PA (da utilizzare all'interno del coperchio per serrare i grani della piastra di ancoraggio degli operatori metallici) Reinforcement plate for operators in metal enclosures PA (to be used inside the cover to tighten the grains of the anchorage plate of metal operators)	ACC-622
	Per il fissaggio sul fondo di operatori metallici non luminosi solo ø22 For mounting on the bottom of metal non illuminated operators ø22 only Alimentazione diretta per custodie / Direct supply for enclosures Fissaggio a vite su retropannello / Screw mounting on rear panel	ACC-415
	Apertura ritardata / Late break	1NC 1NO
	Chiusura anticipata / Early make	1NC 1NO
	Placchetta antipolvere / Dust plate protection	1 contatto / 1 contact 2 contatti / 2 contacts
		ACC-973 ACC-096
	Placchetta di aggancio contatti fondoquadro Docking plate for base mounting contacts	1 contatto / 1 contact 2 contatti / 2 contacts
		ACC-021 ACC-538
	Chiave di serraggio per controgchiere (ø22 mm) Tightening key for lock-nut (ø22 mm)	ACC-396
	Chiave normalmente fornita con i selettori Key normally supplied with the selectors	ACC-CH00E1

# Serie P ø22 mm, ø30 mm | P Series ø22 mm

## Accessori

### Accessories

#### Attuatori e specole con simbologia ISO 1 / Actuators and lents with symbolism ISO 1

	Simboli / Iscrizioni Symbols / Inscriptions	Attuatori / Actuators PRM-010M22 / PR-010T22		Specole / Lens	
				PRM-120M22 PRM-122M22	PR-600M22 PR-601T22 PR-602T22
<b>Serie ø22 rotonda / ø22 round series</b>  	○	ATT-200R	ATT-200N	ATT-230	ATT-245
	I	ATT-201N	ATT-201B	ATT-201V	ATT-246
	II	ATT-202N		ATT-202V	ATT-247
	→	ATT-203N		ATT-203V	ATT-248
	STOP	ATT-204R		ATT-234	ATT-249
	START	ATT-205N		ATT-235	ATT-250
	ARRESTO	ATT-206R		ATT-236	ATT-251
	MARCIA	ATT-207N		ATT-237	ATT-252

R = Rosso / Red - V = Verde / Green - N = Nero / Black

#### Targhette per pulsantiera PB / Legend plates for PB pushbutton

	Descrizione / Description	Codice / Code	Descrizione / Description	Codice / Code
Targhetta autoadesiva (per custodie isolanti) Self adhesive legend plates (for insulating enclosures)	AVANTI	ACC-467	START	ACC-465
	INDIETRO	ACC-468	STOP	ACC-466
	FORWARD	ACC-469	0 - 1	ACC-481
	REVERSE	ACC-470	Neutra / Neutral	ACC-464

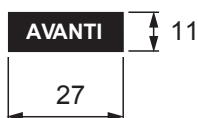

#### Targhette per pulsantiera PA / Legend plates for PA pushbutton

	Descrizione / Description	Codice / Code	Descrizione / Description	Codice / Code	
Targhetta autoadesiva (per custodie isolanti) Self adhesive legend plates (for insulating enclosures)	START	ACC-980	MONTEE	ACC-993	
	STOP	ACC-981	DESCENTE	ACC-994	
	AVANTI	ACC-982	SINISTRA	ACC-995	
	INDIETRO	ACC-983	DESTRA	ACC-399	
	FORWARD	ACC-984	NED	ACC-397	
	REVERSE	ACC-985	OP	ACC-998	
	ON	ACC-986	UP	ACC-999	
	OFF	ACC-987	DOWN	ACC-000	
	IMPULSO	ACC-388	APRE	ACC-001	
	MARCHE	ACC-989	CHIUDE	ACC-002	
	ARRET	ACC-990	0 1	ACC-003	
	ARRIERE	ACC-991	2 0 1	ACC-004	
	AVANT	ACC-992	1 0 2	ACC-005	

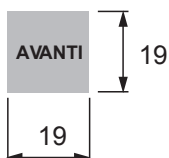



# Serie P ø22 mm | P Series ø22 mm

## Accessori - Targhette in termoplastico e alluminio

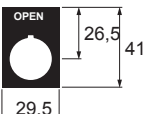
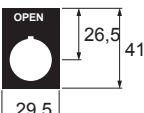
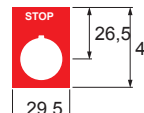
## Accessories - Thermoplastic and aluminum legend plates

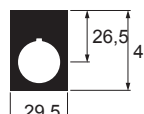
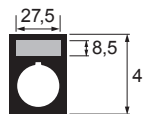
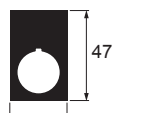
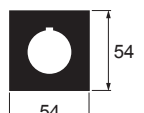
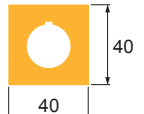
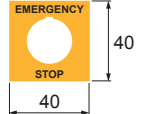
	Descrizione / Description	Codice / Code	Descrizione / Description	Codice / Code	
<b>Per pulsanti / For buttons</b>  Termoplastico / Thermoplastic	ACCESO	ACC-445	INSERITO	ACC-915	
	APRE	ACC-914	LENTO	ACC-917	
	ARRESTO	ACC-906	MANUALE	ACC-919	
	AUMENTA	ACC-286	MARCIA	ACC-905	
	AUTOMATICO	ACC-920	OFF	ACC-932	
	AVANTI	ACC-907	ON	ACC-931	
	CHIUDE	ACC-913	OPEN	ACC-929	
	CLOSE	ACC-526	OUT	ACC-934	
	CLOSED	ACC-930	RAPIDO	ACC-918	
	DESTRA	ACC-912	REVERSE	ACC-942	
	DIMINUISCE	ACC-287	RUN	ACC-940	
	DISCESA	ACC-910	SALITA	ACC-909	
	DISINSERITO	ACC-916	SINISTRA	ACC-911	
	DOWN	ACC-936	SLOW	ACC-938	
	FAST	ACC-937	SPENTO	ACC-446	
	FORWARD	ACC-941	START	ACC-520	
	IN	ACC-933	STOP	ACC-521	
	INCH	ACC-939	UP	ACC-935	
	INDIETRO	ACC-908			
<b>Per selettori / For selectors</b>  Termoplastico / Thermoplastic	0 1	ACC-923	INS DIS	ACC-711	
	0 1 2	ACC-804	ON OFF AUTO	ACC-763	
	1 2	ACC-988	OPEN OFF CLOSED	ACC-927	
	1 0 2	ACC-720	0 1	ACC-921	
	2 0 1	ACC-922	OFF ON	ACC-447	
	APRE CHIUDE	ACC-926	0 MAN	ACC-721	
	ARR. MARCIA	ACC-925	1 2	ACC-805	
	AUTO MAN	ACC-924			
	AUTO 0 MAN	ACC-928			
	AVAN. 0 INDIET.	ACC-976			
	<b>Fondo rosso / Red plate</b>  Termoplastico / Thermoplastic	ARRESTO	ACC-949		
		EMERGENZA	ACC-950		
STOP		ACC-948			
Neutra / Neutral		ACC-851			

	Descrizione / Description	Codice / Code		Descrizione / Description	Codice / Code
	In alluminio (da pantografare), neutra <i>Aluminum (to be engraved)</i>	ACC-414		In termoplastico con targhetta in alluminio 8,5x27,5 (da pantografare), neutra <i>In thermoplastic with aluminum legend plate 8,5x27,5 (to be engraved), neutral</i>	ACC-382
	In termoplastico (da pressoincidere) neutra <i>Thermoplastic (to be inscribed), neutral</i>	ACC-850			
	In alluminio (da pantografare), neutra <i>Aluminum (to be engraved), neutral</i>	ACC-802		In termoplastico (da pressoincidere), neutra <i>Thermoplastic (to be inscribed), neutral</i>	ACC-497
	In termoplastico, fondo giallo, neutra <i>Thermoplastic, yellow color, neutral</i>	ACC-691G			
	In termoplastico, fondo giallo, neutra <i>Thermoplastic, yellow color, neutral</i>	ACC-691G		In termoplastico, fondo giallo <i>Thermoplastic, yellow color</i> EMERGENCY STOP	ACC-692
	Targhetta autoadesiva, fondo giallo <i>Self adhesive, yellow color</i>	ACC-673			
	ARRESTO EMERGENZA EMERGENCY STOP Neutra / Neutral	ACC-673 ACC-671 ACC-670		ARRESTO EMERGENZA EMERGENCY STOP Neutra / Neutral	ACC-406 ACC-407 ACC-405

# Serie P | P Series

## Caratteristiche tecniche

### Technical specifications

#### Normativa | Standard

I colori per i pulsanti di avviamento sono il bianco, il grigio o il nero, con una preferenza per il bianco. È ammesso anche il verde. Il rosso non deve essere usato.

Il colore rosso deve essere usato per i pulsanti di arresto di emergenza. I colori per i pulsanti di arresto sono il nero, il grigio o il bianco, con una preferenza per il nero. È ammesso anche il rosso. Il verde non deve essere usato.

Il Bianco, il grigio e il nero sono i colori preferiti per i pulsanti che provocano alternativamente l'avviamento o l'arresto. I colori rosso, giallo o verde non devono essere usati.

Il Bianco, il grigio e il nero sono i colori preferiti per i pulsanti che provocano un funzionamento quando sono premuti e un arresto quando sono rilasciati (es. azione mantenuta).

I colori rosso, giallo o verde non devono essere usati. Il verde è riservato per funzioni che indicano condizioni normali o di sicurezza.

Il giallo è riservato per funzioni che indicano attenzione o condizioni anormali. Il blu è riservato per funzioni di significato obbligatorio.

I pulsanti di ripristino devono essere blu, bianchi, grigi o neri. Quando vengono utilizzati anche come pulsanti di arresto/disinserzione vengono preferiti il bianco, il grigio o il nero con una netta preferenza per il nero. Non deve essere utilizzato il verde.

Colours used for starting pushbuttons are white, grey or black, preferably white. Also green is permitted. Red is not to be used. Red must be used for emergency stop pushbuttons.

The colours for the stop pushbuttons are black, grey or white, preferably black. Also red is permitted. Green is not to be used. White, grey and black are recommended colours for start/stop pushbuttons. Not to be used colours are red, yellow or green.

White, grey and black are recommended colours for maintained pushbuttons.

Red, yellow or green are not to be used. Green is the colour reserved to those functions indicating standard or safety conditions. Yellow is the colour reserved to those functions indicating dangerous or non-standard conditions. Blue is the colour reserved to all compulsory functions.

Reset pushbuttons must be blue, white, grey or black. When used as stop/switch off pushbuttons, colours recommended are white, grey or black with a strong preference for black. Green is not to be used.

#### Pulsanti (non luminosi) | Pushbuttons (non-illuminated)

**ROSSO / RED**  
Emergenza (azionare in caso di condizione pericolosa o emergenza). / *Emergency (push in case of danger or emergency).*

**GIALLO / YELLOW**  
Anormale (azionare in caso di condizione anormale). / *Non-standard (push in case of non-standard condition).*  
Intervento per sopprimere una condizione anormale o per riavviare un ciclo automatico interrotto. / *Pushing to stop one non-standard condition or re-start one interrupted automatic cycle.*

**VERDE / GREEN**  
Sicurezza (azionare in caso di condizione di sicurezza). / *Safety (push in case of safety condition or to prepare one standard condition).*

**BLU / BLUE**  
Obbligatorio (azionare in caso di condizione che richiede un'azione obbligatoria). / *Compulsory (push when a condition requires one compulsory action).*  
Funzione di ripristino. / *Reset function.*

**BIANCO / WHITE**  
Non viene attribuito alcun significato specifico / *No particular meaning.*  
Per l'avvio generale delle funzioni ad eccezione dell'arresto di emergenza. Ⓞ  
*For general start of functions except the emergency stop.* Ⓞ  
Avvio (preferenziale) o arresto. / *Start (optional) or stop.*

**GRIGIO / GREY**  
Non viene attribuito alcun significato specifico / *No particular meaning.*  
Per l'avvio generale delle funzioni ad eccezione dell'arresto di emergenza. Ⓞ  
*For general start of functions except the emergency stop.* Ⓞ  
Avvio o arresto. / *Start or stop.*

**NERO / BLACK**  
Non viene attribuito alcun significato specifico / *No particular meaning.*  
Per l'avvio generale delle funzioni ad eccezione dell'arresto di emergenza. Ⓞ  
*For general start of functions, except the emergency stop.* Ⓞ  
Arresto (preferenziale) o avvio. / *Stop (optional) or start.*

Ⓞ Quando viene utilizzato un mezzo supplementare di codifica (es. struttura, forma, posizione) per l'identificazione degli attuatori a pulsante, lo stesso colore bianco, grigio o nero può essere utilizzato per varie funzioni (es. bianco per attuatori di avvio o arresto).

Ⓞ In case of use of an additional coding (for example body, shape, position) to identify pushbuttons actuators, the same colour white, grey or black can be employed for different functions (for example white for starting or stop actuators).

#### Indicatori luminosi | Pilot lights

**ROSSO / RED**  
Emergenza (condizioni pericolose). / *Emergency (dangerous conditions).*  
Azione immediata per trattare una condizione pericolosa (es. azionando l'arresto di emergenza). / *Immediate action to solve one dangerous situation (es. pushing the emergency stop).*

**GIALLO / YELLOW**  
Anormale (condizione anormale o critica). / *Non-standard (non-standard or difficult situation).*  
Controllo o intervento (es. ristabilendo la funzione desiderata). / *Control or intervention (es. re-establishing the desired function).*

**VERDE / GREEN**  
Normale (condizione normale). / *Standard (standard condition).*  
Autorizzazione a procedere. / *Authorization to proceed.*

**BLU / BLUE**  
Obbligatorio (indicazione della condizione che richiede un'azione dell'operatore). / *Compulsory (indicates that an operator intervention is needed).*  
Azione obbligatoria. / *Obligation.*

**BIANCO / WHITE**  
Neutro (controllo e informazione generale) / *Neutral (control and general information).*  
Può essere usato ogni volta che si ha un dubbio sull'impiego dei colori rosso, giallo, verde e blu. / *It can be used in any case of doubt as an alternative to red, yellow, green and blue colours.*

#### Pulsanti luminosi

Gli attuatori dei pulsanti luminosi devono essere colorati secondo il codice colore di "Pulsanti e indicatori luminosi". Quando risulta difficile assegnare un colore appropriato, deve essere usato il bianco.

#### Illuminated pushbuttons

Illuminated pushbuttons actuators must be coloured according to "Pushbuttons and pilot lights" colour code. When a suitable colour is difficult to be determined, it is necessary to use white.

# Serie P | P Series

## Caratteristiche tecniche

### Technical specifications

CORRENTE ALTERNATA / ALTERNATING CURRENT (IEC / EN 60947-5-1)		Elementi di contatto / Contact blocks						
		V01V10V01LV10E\F01F10\F01LF10E\B01B10\B01LB10E						
		(serie ø22,30)						
Tensione nominale di isolamento / Rated insulation voltage $U_i$	V	690						
Tensione nominale di tenuta a impulso / Rated impulse withstand voltage $U_{imp}$	kV	6						
Tensione nominale d'impiego / Rated operating voltage $U_e$	V	24	48	110/120	240	400	500	600
Corrente nominale d'impiego / Rated operating current $I_e$								
AC-15 Carichi elettromagnetici >72VA / Electromagnetic loads	A	10	8,5	6,5	4,5	2,6	2,1	1,6
AC-12 Carichi resistivi e carichi a stato solido opto-isolati	A	-	-	-	-	-	-	-
Resistive loads and solid state loads with insulation by opto couplers								
AC-13 Carichi a stato solido con trasformatore di isolamento	A	-	-	-	-	-	-	-
Solid state loads with transformer insulation								
Valori nominali per bassi livelli di energia / Rated values for low energy levels		28V DC - 7 mA						
Corrente nominale termica / Thermal rated current								
in aria libera (IEC) / in air (IEC) $I_{th}$	A	12						
in custodia (IEC-UL/CSA) / in enclosure (IEC-UL/CSA) $I_{the}$	A	10						
Categoria / Classe di isolamento / Category / Protection class		Gruppo C / C Group (VDE 01106) - Classe II / Class II (CEI 23-11)						
Potenza dissipata alla corrente termica / Power dissipation at thermal rated current $I_{the}$	W	≤ 0,3						
Protezione contro il cortocircuito / Short-circuit protection		1 kA (fusibile NDZ 10A-500V gL/gG)						

CORRENTE CONTINUA / DIRECT CURRENT (IEC / EN 60947-5-1)		V01V10\F01F10\B01B10						
		V01LV10E\F01LF10E\B01LB10E						
TENSIONE NOMINALE D'IMPIEGO $U_e$ / RATED OPERATING VOLTAGE	V	24	48	125	250	440	500	600
DC-12 Carichi resistivi e carichi a stato solido opto-isolati								
Resistive loads and solid state loads with insulation by opto couplers								
Corrente nominale d'impiego / Rated operating current $I_e$	A	-	-	-	-	-	-	-
DC-13 Comando di elettromagneti / Control of electromagnets								
Corrente nominale d'impiego / Rated operating current $I_e$	A	4	2	1,1	0,55	0,31	0,27	0,2
Durata di vita elettrica in AC con $U_e, I_e$ (cicli di manovre)		200.000 (AC-15)						
Electrical life in AC with $U_e, I_e$ (operations)								
Durata di vita elettrica in DC con $U_e, I_e$ (cicli di manovre)		- (DC-13)						
Electrical life in DC with $U_e, I_e$ (operations)								

UL / CSA		V01V10\F01F10\B01B10	V01LV10E\F01LF10E\B01LB10E
General use		6A-600V AC / 6A-125V DC	6A-600V AC / 4A-125V DC
Heavy Pilot Duty (HD)	codice designazione / code designation	A600(HD)	A600(HD)
Standard Duty (SD)	codice designazione / code designation	P600 (SD)	P150 (SD)

ALIMENTAZIONI (serie Ø22, 30) / POWER SUPPLIES (Ø 22, 30 series)		Diretta Direct supply	Trasformatore Transformer	Resistore Resistor	Lampeggiatore Flasher
Tensione nominale di isolamento / Rated insulation voltage $U_i$	V	250	-	250	250
Tensione nominale di impiego massima / Maximum rated voltage $U_{e max}$	V	250	-	250	24 130
Tensione nominale circuito primario / Rated voltage primary circuit	V	-	110/220 110/220/380	110/48 220/110	- -
Tensione nominale circuito secondario / Rated voltage secondary circuit	V	-	6 24	48 130/48	- -
Frequenza / Frequency	Hz	-	50/60 50/60	- -	50/60 50/60
Frequenza lampeggi al minuto alla tensione nominale		-	-	-	70 ± 10 70 ± 5
Flash frequency at rated voltage (per min)					
Tempo di inizio lampeggi al minuto alla tensione nominale		-	-	-	< 20 sec immediato
Flash begins at minute at rated voltage					immediate
Alimentazione / Power supply		AC-DC	AC-DC	AC-DC AC	AC-DC AC
Potenza nominale d'impiego / Rated power	W	2	0,6..1 2..3	1,2 2..2,6/1,2	2..12 1..12
Resistenza al cortocircuito del secondario per costruzione					
Short-circuit resistant of the secondary circuit for building					
<b>Sezioni massime collegabili / Max connecting cable sections</b>					
Calibro massimo sezione conduttori secondo IEC/EN 60947-5-1		A3	A2	A1	A3
Max cable section according to IEC/EN 60947-1					
Rigido e flessibile / Rigid and stranded	N. x mm <sup>2</sup>	1x0,5..3,3 o 2x2,5	1x1..2,5 o 2x2,5	1x0,75..1,5 o 2x1,5	1x0,5..3,3 o 2x2,5
	N. x AWG	1x20..12 o 2x14	1x14..12 o 2x14	1x18..16 o 2x16	1x20..12 o 2x14
<b>Morsetti / Terminals</b>					
	Tipo / Type	Vite / Screw	Vite / Screw	Vite / Screw	Vite / Screw
	Filettatura / Thread	M3,5	M3,5	M3,5	M3,5
	Grandezza cacciavite Lama/Croce / Screwdriver size blade/cross	3/2	3/2	3/2	3/2



# Serie P | P Series

## Caratteristiche tecniche

### Technical specifications

INDICATORI LUMINOSI / ILLUMINATED INDICATORS		ø22, 30	Monolitici / Monolithic		Jumbo light
Attacco portalampada / Lampholder type		BA 9s	ø22 BA 9s/E10	ø30 E14/BA 15d	E14
Potenza nominale d'impiego / Rated operating power	W	2	2,6	6	1
Tensione nominale di isolamento / Rated insulating voltage $U_i$	V	250	250	250	250
Tensione nominale d'impiego massima / Rated maximum operating voltage $U_{e\ max}$	V	250	250	250	250
Tensione nominale di tenuta a impulso / Impulse withstand rated voltage $U_{imp}$	kV		4	4	4
Sezioni massime collegabili / Max connecting cable sections					
Calibro max sezione conduttori secondo / Max cable section according to IEC/EN 60947-1		A3	B1	A1	A2
Flessibile/Rigido cordato / Stranded / rigid	N. x mm <sup>2</sup>	2x0,5..1,5	2x0,5..1,5	2x0,75..1,5	2x1..2,5
	N. x AWG	2x20..16	2x20..16	2x18..16	2x18..14
<b>Morsetti / Terminals</b>					
	Coppia di serraggio / Torque force Nm	0,8	0,8	0,8	1
	Tipo vite / Screw type	Vite / Screw	Vite / Screw	Vite / Screw	Vite / Screw
	Filettatura / Thread	M3	M3	M3	M3,5
	Grandezza cacciavite Lama/Croce / Screwdriver size blade/cross	2/-	2/-	2/-	3/2

DATI AMBIENTALI / ENVIRONMENTAL DATA		(serie Ø 22, 30 - Monolitici / Monolithic - Jumbo light)	
Temperatura ambiente / Ambient temperature:	Esercizio / Operating	-25°C	+60°C
	Stoccaggio / Storage	-40°C	+80°C

DATI MECCANICI / MECHANICAL DATA		V01V10 V01LV10E F01F10 F01LF10E B01B10 B01LB10E (serie Ø 22, 30 - Monolitici / Monolithic - Jumbo light)	
Grado di protezione / Protection degree according IEC / EN 60529		Frontale / Front IP65 - Posteriore / Rear IP20	
<b>Durata di vita meccanica</b> (Milioni di manovre) / <b>Mechanical life</b> (millions of operations)			
Pulsanti instabili luminosi e non luminosi / Illuminated and not illuminated momentary pushbuttons		6	
Pulsanti stabili luminosi e non luminosi / Illuminated and not illuminated maintained pushbuttons		1	
Selettori non luminosi / Non illuminated selector switches		1	
Selettori luminosi / Illuminated selector switches		0,2	
Pulsante a fungo di emergenza / Emergency stop mushroom pushbuttons		0,2	
Pulsanti a fungo stabili / Maintained mushroom pushbuttons		0,2	
Pulsanti stabili passo-passo metallici / Metal push-push maintained pushbuttons		3	
Pulsante stabili passo passo plastici / Thermoplastic push-push maintained pushbuttons		2	
Manipolatori a leva / Joysticks		1	
Pulsantiere con operatori instabili / Control stations with momentary pushbuttons		6	
<b>Resistenza alle vibrazioni</b> (fissaggio retroquadro) / <b>Resistance to vibrations</b> (front mounting)			
Frequenza / Frequency	Hz	2..13,2 - 10..100Hz	
Ampiezza urti/spostamenti / Width of impact/movement	mm	± 1	
Accelerazione / Acceleration	g	0,7	
<b>Sezioni massime collegabili / Maximum cable sections</b>			
Calibro massimo sezione conduttori / Maximum cables section according IEC/EN 60947-5-1		A3	
Rigido e flessibile / Rigid and stranded	N. x mm <sup>2</sup>	1 x 0,5..3,3 o 2 x 2,5	
	N. x AWG	1 x 20..12 o 2 x 14	
<b>Morsetti / Terminals</b>			
	Tipo / Type	Vite / Screw	
	Filettatura / Thread	M3,5	
	Grandezza cacciavite Lama/Croce / Screwdriver size blade/cross	3/2	
	Tipo / Connection type	Innesto / Graft 1x6,3mm or 2x2,8mm	
<b>N. massimo di contatti sugli operatori / Maximum contacts number on operators</b>			
Non luminosi e luminosi con alimentazione diretta / Lighted and unlighted with direct supply		4 (su 2 livelli) / 4 (on 2 levels)	
Selettori non luminosi / Non illuminated selector switches		4 (su 2 livelli) / 4 (on 2 levels)	
Luminosi con trasformatore o resistore / Illuminated with transformer or resistor		2 (su 2 livelli) / 2 (on 2 levels)	
Luminosi e non luminosi passo-passo / Illuminated and not illuminated push-push		2 (su 1 livello) / 2 (on 1 level)	

### Dime di foratura / Fixing holes

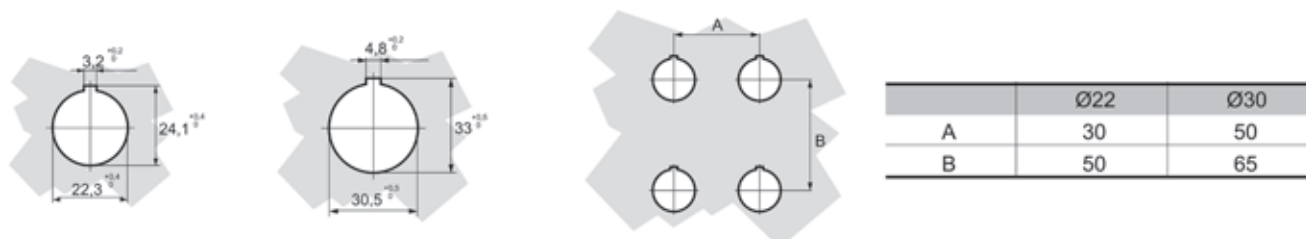

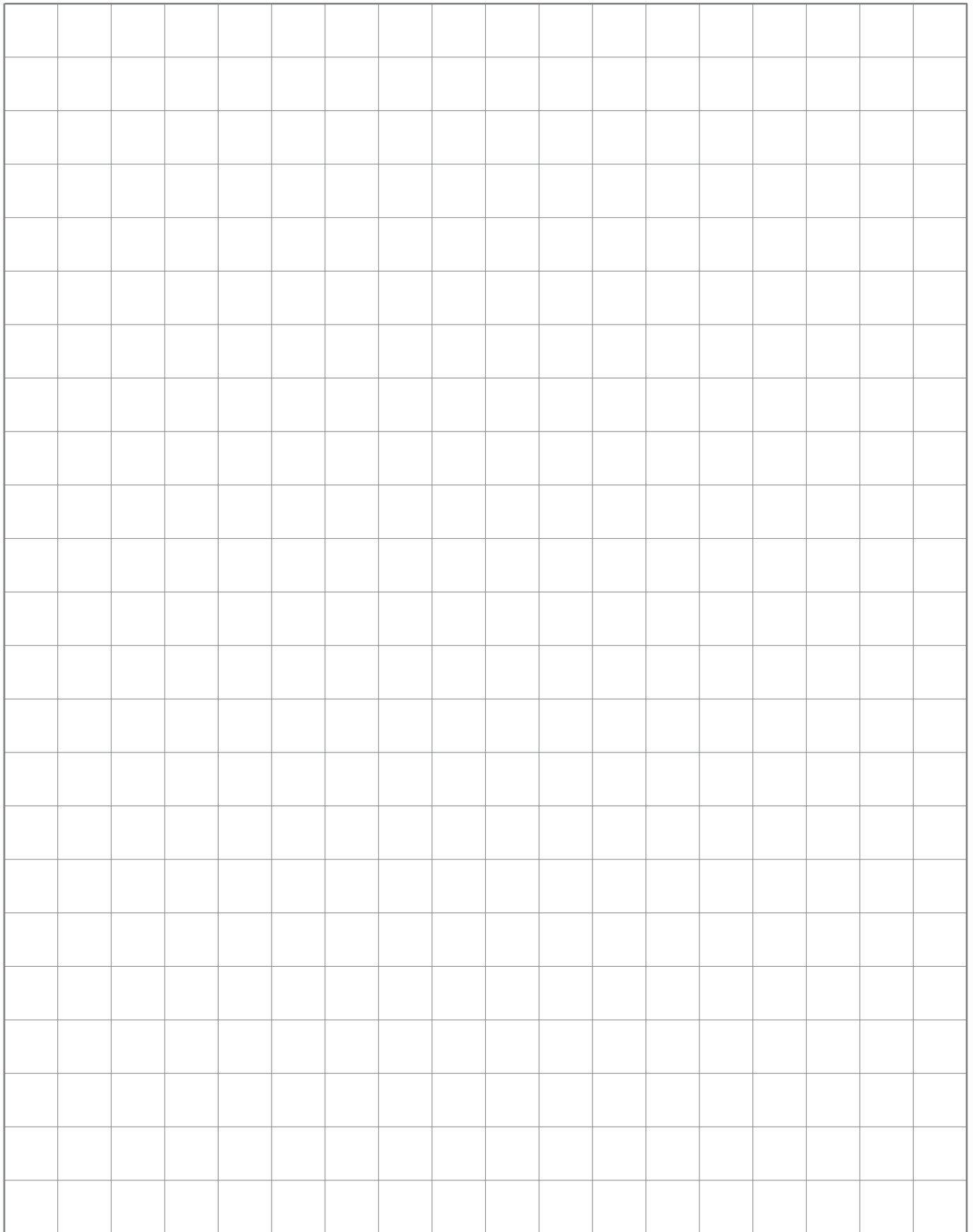

**ITALWEBER S.p.A.**  
Via Enrico Fermi, 40/42  
20090 Assago, (MI)  
Tel. +39 02 93977.1  
Fax +39 02 93904565

info@italweber.it  
www.italweber.it  
www.italweber.solutions

**Lombardia  
(BG-BS-CR-MN)**  
**SALERNO RAPPRESENTANZE & C. sas**  
Via Stezzano, 18/C3  
24052 Azzano S. Paolo (BG)  
Tel. 035.532063  
Fax 035.4511077

**Lombardia  
(MI-MB-PV-LO-PC)**  
**ALA TECH Snc  
di GHIDINI ANDREA & C.**  
Largo B. Salvadori, 1  
20851 Lissone (MB)  
Tel. 039.8960197  
Fax 039.8944236

**Lombardia  
(CO-LC-SO)**  
**VERGA RAPPRESENTANZE srl**  
Via XXV Aprile, 39  
20091 Bresso (MI)  
Tel. 02.6142700  
Fax 02.73960116

**Piemonte+Lombardia  
(NO-VC-BI-VB-VA)**  
**ENERGYE RAPPRESENTANZE  
di FUSI EZIO**  
Via A. Brustio, 21  
28066 Galliate (NO)  
Tel. 0321.866628  
Fax 0321.809889

**Piemonte - Valle D'Aosta  
(AT-CN-TO-AO)**  
**BONGIORNI sas**  
Corso Tassoni, 21  
10143 Torino  
Tel. 011.7496079  
Fax 011.7412803

**Liguria+AL  
(GE-IM-SV-SP-AL)**  
**LETTIERI RICCARDO**  
Via Robino, 18/30  
16142 Genova  
Tel. 010.8687762  
Fax 010.8687762

**Emilia Romagna + RSM  
(BO-FE-FO-MO-PR-RA-RE-RN)**  
**EMMELLE RAPPRESENTANZE snc  
di NEROZZI M. & TARTARI L.**  
P.zza Case Bonazzi, 7  
40050 Monte San Pietro (BO)  
Tel. 051.19907279  
Fax 051.0544240

**Veneto  
(PD-VI-VE)**  
**VOLPIANA RAPPRESENTANZE srl**  
Strada Marosticana, 90  
36100 Vicenza (VI)  
Tel. 0444.926029  
Fax 0444.937212

**Veneto-Friuli  
(TV-BL-GO-PN-TS-UD)**  
**MEM RAPPRESENTANZE INDUSTRIALI**  
Viale Veneto, 30  
35020 Saonara (PD)  
Tel. 345.0959787  
Fax 049.7969211

**Toscana  
(AR-FI-GR-LI-LU-MS-PI-PT-SI-PO)**  
**STARK ELETRORAPPRESENTANZE  
di BONGIANNI FULVIO & C. sas**  
Via degli Artigiani, 54  
50041 Calenzano (FI)  
Tel. 055.8827485  
Fax 055.8873488

**Trentino Alto Adige - Veneto  
(VR-TN-BZ-RO)**  
**MALESANI Sas**  
Via Zenati, 6  
37060 Buttapietra (VR)  
Tel. 338.2971633  
Fax 045.6661710

**Marche  
(AN-AP-MC-PU-FM)**  
**I.T.G. Snc  
di ARGENTATI ANDREA  
e MAZZOLI SIMONE**  
Strada del Cavallo, 87  
60019 Senigallia (AN)  
Tel. 071.7999483  
Fax 071.7990603

**Abruzzo-Molise  
(CH-CB-IS-TE-AQ-PE)**  
**DI FEDERICO snc & C.**  
Strada Pandolfi, 47/1  
65125 Pescara  
Tel. 085.413560  
Fax 085.4155413

**Lazio-Umbria  
(RM-FR-LT-RI-VT-PG-TR)**  
**GIORDANO BARCHIESI**  
Via Masserano, 4  
00166 Roma  
Tel. 06.6245074  
Fax 06.6242266

**Puglia-Basilicata  
(BA-BR-FG-LE-TA-MT)**  
**ELETRORAPPRESENTANZE  
di MODUGNO SALVATORE**  
Via Don Cosmo Azzollini, 10  
70056 Molfetta (BA)  
Tel. 080.3975612  
Fax 080.3352867

**Campania-Basilicata  
(AV-BN-CE-NA-SA-PZ)**  
**CAREL srl**  
Via Domenico De Roberto, 44  
80143 Napoli  
Tel. 081.5846527  
Fax 081.2509223

**Sardegna  
(CA-NÜ-OR-SS)**  
**OPEN SPACE srl**  
Via Dorgali, 42  
09042 Monserrato (CA)  
Tel. 070.8587666  
Fax 178.6023413

**Calabria  
(CZ-CS-RC-VV-KR)**  
**RA.EL.TE. snc**  
Via Carcara, 9  
88068 Soverato (CZ)  
Tel. 0967.521421  
Fax 0967.521442

**Sicilia  
(PA-AG-TP-CL)**  
**ELE.CO. Sas  
di F. BADALAMENTI**  
Via Villa Verona, 35  
90146 Palermo  
Tel. 091.6888360  
Fax 091.6884555

**Sicilia  
(CT-ME-RG-SR-EN)**  
**GENELECTRIC  
di ENRICO M. SCIACCA & C. Sas**  
Via Mazzini, 5  
95030 Sant'Agata Li Battiati (CT)  
Tel. 095.7253636  
Fax 095.7254229



# ITALWEBER

Un mondo di protezione

Via E. Fermi, 40/42 - 20090 Assago (MI) Italia  
Tel. +39 02 93977.1 - Fax +39 02 93904565  
[info@italweber.it](mailto:info@italweber.it)



[italweber.it](http://italweber.it)

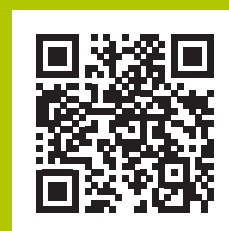

[italweber.solutions](http://italweber.solutions)