

Last Revised: 2014-11-06 07:14:42.0

## High-Speed M Series Multifunction DAQ for USB - 16-Bit, up to 1.25 MS/s, up to 80 Analog Inputs



- Up to 80 analog inputs at 16 bits, 1.25 MS/s (1 MS/s or 750 kS/s scanning)
- Up to 4 analog outputs at 16 bits, 2.86 MS/s
- Up to 48 TTL/CMOS digital I/O lines (up to 32 hardware-timed at up to 1 MHz)
- Two 32-bit, 80 MHz counter/timers
- Analog and digital triggering supported; power supply included
- NI-PGIA 2 and NI-MCal calibration technology for improved measurement accuracy
- NI signal streaming for 4 high-speed data streams on USB
- NI-DAQmx driver software and LabVIEW SignalExpress LE included

### Overview

With recent bandwidth improvements and new innovations from National Instruments, USB has evolved into a core bus of choice for measurement and automation applications. NI M Series high-speed devices for USB deliver high-performance data acquisition in an easy-to-use and portable form factor through USB ports on laptop computers and other portable computing platforms. NI created NI signal streaming, an innovative patent-pending technology that enables sustained bidirectional high-speed data streams on USB. The new technology, combined with advanced external synchronization and isolation, helps engineers and scientists achieve high-performance applications on USB.

M Series high-speed multifunction data acquisition (DAQ) modules for USB are optimized for superior accuracy at fast sampling rates. They provide an onboard NI-PGIA 2 amplifier designed for fast settling times at high scanning rates, ensuring 16-bit accuracy even when measuring all available channels at maximum speed. All high-speed devices have a minimum of 16 analog inputs, 24 digital I/O lines, seven programmable input ranges, analog and digital triggering, and two counter/timers. USB M Series devices are ideal for test, control, and design applications including portable data logging, field monitoring, embedded OEM, in-vehicle data acquisition, and academic. High-speed NI USB-625x M Series devices have an extended two-year calibration interval.

[Back to Top](#)

### Requirements and Compatibility

#### OS Information

- Windows 2000/XP
- Windows 7
- Windows Vista x64/x86

#### Driver Information

- NI-DAQmx

#### Software Compatibility

- ANSI C/C++
- LabVIEW
- SignalExpress
- Visual C#
- Visual Studio .NET

[Back to Top](#)

### Comparison Tables

Family	Connector	Analog Inputs	Resolution	Max Rate	Analog Outputs	Resolution	Max Rate	Digital I/O	Counter/ Timer
USB-6251	Screw/68-pin SCSI	16 SE/8 DI	16 bits	1.25 MS/s	2	16 bits	2.86 MS/s	24 (8 clocked)	2
USB-6259	Screw/68-pin SCSI	32 SE/16 DI	16 bits	1.25 MS/s	4	16 bits	2.86 MS/s	48 (32 clocked)	2
USB-6255	Screw/68-pin SCSI	80 SE/40 DI	16 bits	1.25 MS/s	2	16 bits	2.86 MS/s	24 (8 clocked)	2

[Back to Top](#)

## Application and Technology

### NI Signal Streaming

Unlike typical multifunction USB data acquisition devices, NI USB M Series DAQ devices incorporate NI signal streaming, a patent-pending technology that combines three innovative hardware- and software-level design elements to enable sustained high-speed and bidirectional data streams over USB. NI signal streaming, along with the error correction, noise rejection, power management, and power distribution inherent in the USB protocol, yields a robust, secure, and reliable bus. Without NI signal streaming, a multifunction data acquisition device could sustain only a single high-speed data stream, effectively making it a single-function device. For more information, visit [ni.com/usb](http://ni.com/usb).

### USB M Series for Test

For test, you can use the M Series high-speed analog inputs and 10 MHz digital lines with NI signal conditioning for applications including test, component characterization, and sensor measurement. High-speed USB-625x M Series devices are compatible with the NI SCC signal conditioning platform, providing amplification filtering and power for virtually every type of sensor. This platform is also compliant with IEEE 1451.4 smart transducer electronic data sheet (TEDS) sensors, which offer digital storage for sensor data sheet information. USB M Series multifunction DAQ devices also complement existing test systems that need additional measurement channels. For higher-channel-count signal conditioning on USB, consider the NI CompactDAQ or NI SCXI platform.

### USB M Series for Control

USB M Series digital lines can drive 24 mA for relay and actuator control. By clocking the digital lines as fast as 10 MHz (with onboard regeneration), you can use these lines for pulse-width modulation (PWM) to control valves, motors, fans, lamps, and pumps. With four waveform analog outputs, two 80 MHz counter/timers, and four high-speed data streams on USB, M Series devices can execute multiple control loops simultaneously. High-speed USB-625x M Series devices also offer direct support for encoder measurements, protected digital lines, and digital debounce filters. With up to 80 analog inputs, 32 clocked digital lines, and four analog outputs, you can execute multiple control loops with a single device.

You can also create a complete custom motion controller by combining USB M Series devices with the NI SoftMotion Development Module.

### USB M Series for Design

For design applications, you can use a wide range of I/O – from 80 analog inputs to 48 digital lines – to measure and verify prototype designs. USB M Series devices and NI LabVIEW SignalExpress interactive measurement software deliver benchtop measurements to the PC. With LabVIEW SignalExpress, you can quickly create design verification tests. The fast acquisition and generation rates of high-performance USB M Series high-speed devices along with LabVIEW SignalExpress provide fast design analysis. You can convert your tested and verified LabVIEW SignalExpress projects to LabVIEW applications for immediate M Series DAQ use, and bridge the gap between test, control, and design applications.

### USB M Series for OEMs

Shorten your time to market by integrating National Instruments OEM products in your design. Board-only versions of USB M Series DAQ devices are available for OEM applications, with competitive quantity pricing and software customization. The NI OEM Elite Program offers free 30-day trial kits for qualified customers. Visit [ni.com/oem](http://ni.com/oem) for more information.

### Recommended Software

National Instruments measurement services software, built around NI-DAQmx driver software, includes intuitive application programming interfaces, configuration tools, I/O assistants, and other tools designed to reduce system setup, configuration, and development time. National Instruments recommends using the latest version of NI-DAQmx driver software for application development in NI LabVIEW, LabVIEW SignalExpress, LabWindows™/CVI, and Measurement Studio. To obtain the latest version of NI-DAQmx, visit [ni.com/support/daq/versions](http://ni.com/support/daq/versions). NI measurement services software speeds up your development with features including:

- A guide to create fast and accurate measurements with no programming using the DAQ Assistant
- Automatic code generation to create your application in LabVIEW; LabWindows/CVI; LabVIEW SignalExpress; and Visual Studio .NET, ANSI C/C++, C#, or Visual Basic using Measurement Studio
- Multithreaded streaming technology for 1,000 times performance improvements
- Automatic timing, triggering, and synchronization routing to make advanced applications easy
- More than 3,000 free software downloads to jump-start your project available at [ni.com/zone](http://ni.com/zone)
- Software configuration of all digital I/O features without hardware switches/jumpers
- Single programming interface for analog input, analog output, digital I/O, and counters on hundreds of multifunction DAQ hardware devices

M Series devices are compatible with the following versions (or later) of NI application software – LabVIEW, LabWindows/CVI, or Measurement Studio versions 7.x or LabVIEW SignalExpress 2.x.

### Recommended Accessories (Mass-Termination Versions)

Signal conditioning is required for sensor measurements or voltage inputs greater than 10 V. NI SCC products, which are designed to increase the performance and reliability of your data acquisition system, are up to 10 times more accurate than using terminal blocks alone. For more information, visit [ni.com/sigcon](http://ni.com/sigcon).

[Back to Top](#)

## Ordering Information

For a complete list of accessories, visit the product page on [ni.com](http://ni.com).

Products	Part Number	Recommended Accessories	Part Number
<b>NI High-Performance M Series Multifunction DAQ for USB</b>			
<b>USB-6259 Screw Term</b>	779628-0P	No accessories required.	
<b>USB-6251 Mass Term</b> Requires: 1 Cable , 1 Connector Block	779694-0P	<b>Cable:</b> Shielded - SH68-68-EPM Noise Rejecting, Shielded Cable, 1 m <i>**Also Available: Unshielded</i> <b>Connector Block:</b> Shielded - SCB-68 Shielded I/O Connector Block for DAQ Devices <i>**Also Available: Unshielded, BNC Termination</i>	199006-01 776844-01

<b>USB-6251 Screw Term</b>	779627-0P	No accessories required.	
<b>USB-6259 Mass Term</b>	779695-0P		
Requires: 2 Cable s, 2 Connector Block s		<b>Connector 0:</b>	
		<b>Cable:</b> Shielded - SH68-68-EPM Noise Rejecting, Shielded Cable, 1 m	199006-01
		<i>**Also Available: BNC Termination, Unshielded</i>	
		<b>Connector Block:</b> Shielded - SCB-68 Shielded I/O Connector Block for DAQ Devices	776844-01
		<i>**Also Available: Unshielded</i>	
		<b>Connector 1:</b>	
		<b>Cable:</b> Shielded - SH68-68-EPM Noise Rejecting, Shielded Cable, 1 m	199006-01
		<i>**Also Available: Unshielded</i>	
		<b>Connector Block:</b> Shielded - SCB-68 Shielded I/O Connector Block for DAQ Devices	776844-01
		<i>**Also Available: BNC Termination, Unshielded</i>	
<b>USB-6255 Screw Term</b>	779958-0P	No accessories required.	
<b>USB-6255 Mass Term</b>	779959-0P		
Requires: 2 Cable s, 2 Connector Block s		<b>Connector 0:</b>	
		<b>Cable:</b> Shielded - SH68-68-EPM Noise Rejecting, Shielded Cable, 1 m	199006-01
		<i>**Also Available: Unshielded</i>	
		<b>Connector Block:</b> Screw Terminal - SCB-68 Shielded I/O Connector Block for DAQ Devices	776844-01
		<i>**Also Available: BNC Termination, Unshielded</i>	
		<b>Connector 1:</b>	
		<b>Cable:</b> Shielded - SH68-68-S Noise Rejecting, Shielded Cable, 1m	185262-01
		<i>**Also Available: Unshielded</i>	
		<b>Connector Block:</b> Shielded - SCB-68 Shielded I/O Connector Block for DAQ Devices	776844-01
		<i>**Also Available: BNC Termination, Unshielded</i>	

Board-Only Devices for Embedded Systems and OEM		
<b>USB-6255 OEM (Quantity 1)</b>	197201-01	No accessories required.
<b>USB-6259 OEM (Quantity 1)</b>	194929-01	No accessories required.
<b>USB-6251 OEM (Quantity 1)</b>	194929-03	No accessories required.

[Back to Top](#)

## Software Recommendations

### LabVIEW Professional Development System for Windows

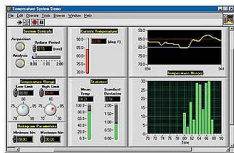

- Advanced software tools for large project development
- Automatic code generation using DAQ Assistant and Instrument I/O Assistant
- Tight integration with a wide range of hardware
- Advanced measurement analysis and digital signal processing
- Open connectivity with DLLs, ActiveX, and .NET objects
- Capability to build DLLs, executables, and MSI installers

### SignalExpress for Windows



- Quickly configure projects without programming
- Control over 400 PC-based and stand-alone instruments
- Log data from more than 250 data acquisition devices
- Perform basic signal processing, analysis, and file I/O
- Scale your application with automatic LabVIEW code generation
- Create custom reports or easily export data to LabVIEW, DIAdem or Microsoft Excel

### NI LabWindows™/CVI for Windows



- Real-time advanced 2D graphs and charts
- Complete hardware compatibility with IVI, VISA, DAQ, GPIB, and serial
- Analysis tools for array manipulation, signal processing statistics, and curve fitting
- Simplified cross-platform communication with network variables
- Measurement Studio .NET tools (included in LabWindows/CVI Full only)
- The mark LabWindows is used under a license from Microsoft Corporation.

### NI Measurement Studio Professional Edition

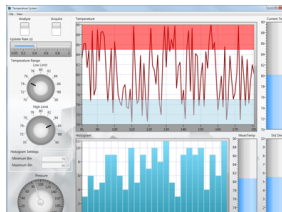

- Customizable graphs and charts for WPF, Windows Forms, and ASP.NET Web Forms UI design
- Analysis libraries for array operations, signal generation, windowing, filters, signal processing
- Hardware integration support with native .NET data acquisition and instrument control libraries
- Automatic code generation for all NI-DAQmx data acquisition hardware
- Intelligent and efficient data-logging libraries for streaming measurement data to disk
- Support for Microsoft Visual Studio .NET 2012/2010/2008

[Back to Top](#)

## Support and Services

## Calibration

NI measurement hardware is calibrated to ensure measurement accuracy and verify that the device meets its published specifications. To ensure the ongoing accuracy of your measurement hardware, NI offers basic or detailed recalibration service that provides ongoing ISO 9001 audit compliance and confidence in your measurements. To learn more about NI calibration services or to locate a qualified service center near you, contact your local sales office or visit [ni.com/calibration](http://ni.com/calibration).

## Technical Support

Get answers to your technical questions using the following National Instruments resources.

- **Support** - Visit [ni.com/support](http://ni.com/support) to access the NI KnowledgeBase, example programs, and tutorials or to contact our applications engineers who are located in NI sales offices around the world and speak the local language.
- **Discussion Forums** - Visit [forums.ni.com](http://forums.ni.com) for a diverse set of discussion boards on topics you care about.
- **Online Community** - Visit [community.ni.com](http://community.ni.com) to find, contribute, or collaborate on customer-contributed technical content with users like you.

## Repair

While you may never need your hardware repaired, NI understands that unexpected events may lead to necessary repairs. NI offers repair services performed by highly trained technicians who quickly return your device with the guarantee that it will perform to factory specifications. For more information, visit [ni.com/repair](http://ni.com/repair).

## Training and Certifications

The NI training and certification program delivers the fastest, most certain route to increased proficiency and productivity using NI software and hardware. Training builds the skills to more efficiently develop robust, maintainable applications, while certification validates your knowledge and ability.

- **Classroom training in cities worldwide** - the most comprehensive hands-on training taught by engineers.
- **On-site training at your facility** - an excellent option to train multiple employees at the same time.
- **Online instructor-led training** - lower-cost, remote training if classroom or on-site courses are not possible.
- **Course kits** - lowest-cost, self-paced training that you can use as reference guides.
- **Training memberships** and training credits - to buy now and schedule training later.

Visit [ni.com/training](http://ni.com/training) for more information.

## Extended Warranty

NI offers options for extending the standard product warranty to meet the life-cycle requirements of your project. In addition, because NI understands that your requirements may change, the extended warranty is flexible in length and easily renewed. For more information, visit [ni.com/warranty](http://ni.com/warranty).

## OEM

NI offers design-in consulting and product integration assistance if you need NI products for OEM applications. For information about special pricing and services for OEM customers, visit [ni.com/oem](http://ni.com/oem).

## Alliance

Our Professional Services Team is comprised of NI applications engineers, NI Consulting Services, and a worldwide National Instruments Alliance Partner program of more than 700 independent consultants and integrators. Services range from start-up assistance to turnkey system integration. Visit [ni.com/alliance](http://ni.com/alliance).

[Back to Top](#)

## Detailed Specifications

Specifications listed below are typical at 25 °C unless otherwise noted. Refer to the *M Series User Manual* for more information about NI 625x devices.

Analog Input	
Number of channels	
NI 6250/6251	8 differential or 16 single ended
NI 6254/6259	16 differential or 32 single ended
NI 6255	40 differential or 80 single ended
ADC resolution	16 bits
DNL	No missing codes guaranteed
INL	Refer to the <i>AI Absolute Accuracy Table</i>
Sampling rate	
Maximum	
NI 6250/6251/6254/6259	1.25 MS/s single channel, 1.00 MS/s multi-channel (aggregate)
NI 6255	1.25 MS/s single channel 750 kS/s multi-channel (aggregate)

Minimum	No minimum
Timing accuracy	50 ppm of sample rate
Timing resolution	50 ns
Input coupling	DC
Input range	±10 V, ±5 V, ±2 V, ±1 V, ±0.5 V, ±0.2 V, ±0.1 V
Maximum working voltage for analog inputs (signal + common mode)	±11 V of AI GND
CMRR (DC to 60 Hz)	100 dB
Input impedance	
Device on	
AI+ to AI GND	>10 GΩ in parallel with 100 pF
AI- to AI GND	>10 GΩ in parallel with 100 pF
Device off	
AI+ to AI GND	820 Ω
AI- to AI GND	820 Ω
Input bias current	±100 pA
Crosstalk (at 100 kHz)	
Adjacent channels	-75 dB
Non-adjacent channels	-90 dB <sup>1</sup>
Small signal bandwidth (-3 dB)	1.7 MHz
Input FIFO size	4,095 samples
Scan list memory	4,095 entries
Data transfers	
PCI/PCIe/PXI/PXle devices	DMA (scatter-gather), interrupts, programmed I/O
USB devices	USB Signal Stream, programmed I/O
Overvoltage protection (AI <0..79>, AI SENSE, AI SENSE 2)	
Device on	±25 V for up to four AI pins
Device off	±15 V for up to four AI pins
Input current during overvoltage condition	±20 mA max/AI pin

<sup>1</sup> For USB-6255 devices, channel AI <0..15> crosstalk to channel AI <64..79> is -67 dB; applies to channels with 64-channel separation, for example, AI (x) and AI (x + 64).

### Settling Time for Multichannel Measurements

NI 6250/6251/6254/6259

Range	±60 ppm of Step (±4 LSB for Full Scale Step)	±15 ppm of Step (±1 LSB for Full Scale Step)
±10 V, ±5 V, ±2 V, ±1 V	1 μs	1.5 μs
±0.5 V	1.5 μs	2 μs
±0.2 V, ±0.1 V	2 μs	8 μs

NI 6255

Range	±60 ppm of Step (±4 LSB for Full Scale Step)	±15 ppm of Step (±1 LSB for Full Scale Step)
±10 V, ±5 V, ±2 V, ±1 V	1.3 μs	1.6 μs

±0.5 V	1.8 μs	2.5 μs
±0.2 V, ±0.1 V	3 μs	8 μs

### Typical Performance Graphs

NI 6250/6251/6254/6259  
Settling Error Versus Time for Different Source Impedances

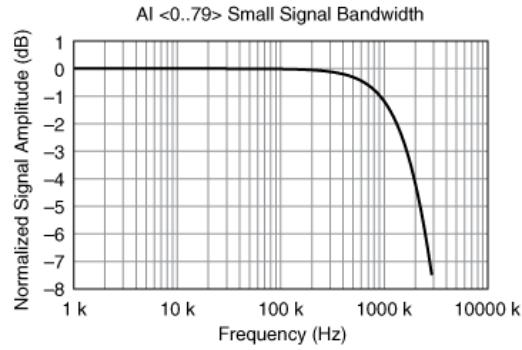
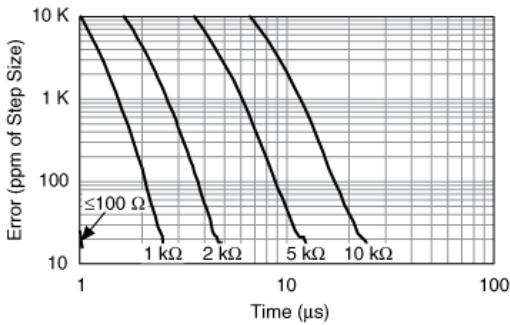

NI 6255  
Settling Error Versus Time for Different Source Impedances

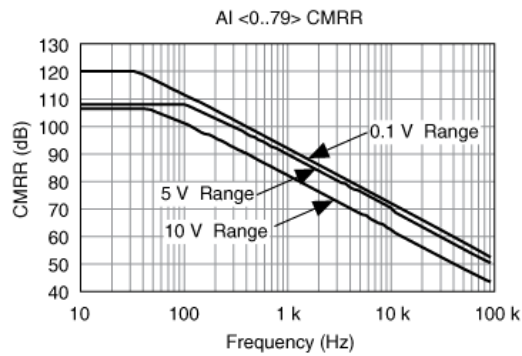
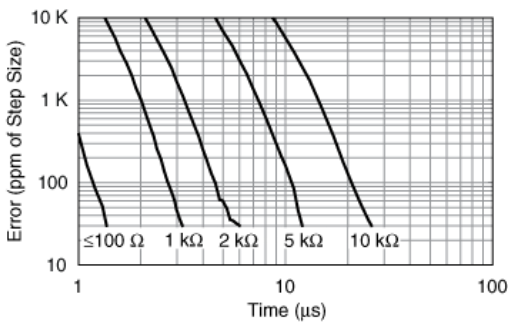

### Analog Triggers

Number of triggers	1
Source	
NI 6250/6251	AI <0..15>, APFI 0
NI 6254/6259	AI <0..31>, APFI <0..1>
NI 6255	AI <0..79>, APFI 0
Functions	Start Trigger, Reference Trigger, Pause Trigger, Sample Clock, Convert Clock, Sample Clock Timebase
Source level	
AI <0..79>	±full scale
APFI <0..1>	±10 V
Resolution	10 bits, 1 in 1,024
Modes	Analog edge triggering, analog edge triggering with hysteresis, and analog window triggering
Bandwidth (-3 dB)	
AI <0..79>	3.4 MHz
APFI <0..1>	3.9 MHz
Accuracy	±1%
APFI <0..1> characteristics	
Input impedance	10 kΩ
Coupling	DC
Protection	
Power on	±30 V
Power off	±15 V

## Analog Output

Number of channels	
NI 6250/6254	0
NI 6251/6255	2
NI 6259	4
DAC resolution	16 bits
DNL	±1 LSB
Monotonicity	16 bit guaranteed
Accuracy	Refer to the <i>AO Absolute Accuracy Table</i>
Maximum update rate	
1 channel	2.86 MS/s
2 channels	2.00 MS/s
3 channels	1.54 MS/s
4 channels	1.25 MS/s
Timing accuracy	50 ppm of sample rate
Timing resolution	50 ns
Output range	±10 V, ±5 V, ±external reference on APFI <0..1>
Output coupling	DC
Output impedance	0.2 Ω
Output current drive	±5 mA
Overdrive protection	±25 V
Overdrive current	20 mA
Power-on state	±5 mV <sup>2</sup>
Power-on glitch	1.5 V peak for 1.5 s
Output FIFO size	8,191 samples shared among channels used
Data transfers	
PCI/PCIe/PXI/PXle devices	DMA (scatter-gather), interrupts, programmed I/O
USB devices	USB Signal Stream, programmed I/O
AO waveform modes:	
▪ Non-periodic waveform	
▪ Periodic waveform regeneration mode from onboard FIFO	
▪ Periodic waveform regeneration from host buffer including dynamic update	
Settling time, full scale step 15 ppm (1 LSB)	2 μs
Slew rate	20 V/μs
Glitch energy at midscale transition, ±10 V range	
Magnitude	10 mV
Duration	1 μs

<sup>2</sup> For all USB-6251/6259 Screw Terminal devices, when powered on, the analog output signal is not defined until after USB configuration is complete.

## External Reference

APFI <0..1> characteristics	
Input impedance	10 kΩ
Coupling	DC
Protection	
Power on	±30 V
Power off	±15 V
Range	±11 V

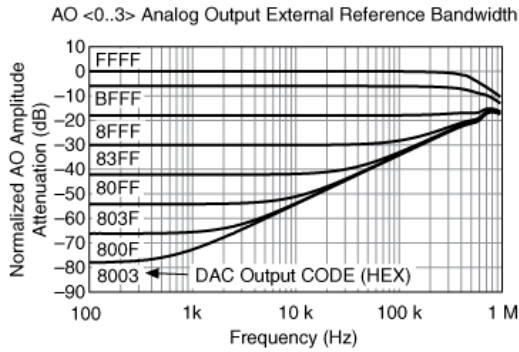

**Calibration (AI and AO)**

Recommended warm-up time 15 minutes

Calibration interval 2 years

**AI Absolute Accuracy Table**

Nominal Range		Residual Gain Error (ppm of Reading)	Gain Tempco (ppm/°C)	Reference Tempco	Residual Offset Error (ppm of Range)	Offset Tempco (ppm of Range/°C)	INL Error (ppm of Range)	Random Noise, σ (μVrms)	Absolute Accuracy at Full Scale <sup>1</sup> (μV)	Sensitivity <sup>2</sup> (μV)
Positive Full Scale	Negative Full Scale									
10	-10	60	13	1	20	21	60	280	1,920	112.0
5	-5	70	13	1	20	21	60	140	1,010	56.0
2	-2	70	13	1	20	24	60	57	410	22.8
1	-1	80	13	1	20	27	60	32	220	12.8
0.5	-0.5	90	13	1	40	34	60	21	130	8.4
0.2	-0.2	130	13	1	80	55	60	16	74	6.4
0.1	-0.1	150	13	1	150	90	60	15	52	6.0

Accuracies listed are valid for up to two years from the device external calibration.

$$\text{AbsoluteAccuracy} = \text{Reading} \cdot (\text{GainError}) + \text{Range} \cdot (\text{OffsetError}) + \text{NoiseUncertainty}$$

$$\text{GainError} = \text{ResidualAIGainError} + \text{GainTempco} \cdot (\text{TempChangeFromLastInternalCal}) + \text{ReferenceTempco} \cdot (\text{TempChangeFromLastExternalCal})$$

$$\text{OffsetError} = \text{ResidualAIOffsetError} + \text{OffsetTempco} \cdot (\text{TempChangeFromLastInternalCal}) + \text{INL\_Error}$$

$$\text{NoiseUncertainty} = \frac{\text{RandomNoise} \cdot 3}{\sqrt{100}} \quad \text{For a coverage factor of } 3 \sigma \text{ and averaging } 100 \text{ points.}$$

<sup>1</sup> Absolute accuracy at full scale on the analog input channels is determined using the following assumptions:

TempChangeFromLastExternalCal = 10 °C

TempChangeFromLastInternalCal = 1 °C

number\_of\_readings = 100

CoverageFactor = 3 σ

For example, on the 10 V range, the absolute accuracy at full scale is as follows:

$$\text{GainError} = 60 \text{ ppm} + 13 \text{ ppm} \cdot 1 + 1 \text{ ppm} \cdot 10 \quad \text{GainError} = 83 \text{ ppm}$$

$$\text{OffsetError} = 20 \text{ ppm} + 21 \text{ ppm} \cdot 1 + 60 \text{ ppm} \quad \text{OffsetError} = 101 \text{ ppm}$$

$$\text{NoiseUncertainty} = \frac{275 \mu\text{V} \cdot 3}{\sqrt{100}} \quad \text{NoiseUncertainty} = 83 \mu\text{V}$$

$$\text{AbsoluteAccuracy} = 10 \text{ V} \cdot (\text{GainError}) + 10 \text{ V} \cdot (\text{OffsetError}) + \text{NoiseUncertainty} \quad \text{AbsoluteAccuracy} = 1920 \mu\text{V}$$

<sup>2</sup> Sensitivity is the smallest voltage change that can be detected. It is a function of noise.

**AO Absolute Accuracy Table**

Nominal Range	Residual Gain Error (ppm of Reading)	Gain Tempco (ppm/°C)	Reference Tempco	Residual Offset Error (ppm of Range)	Offset Tempco (ppm of Range/°C)	INL Error (ppm of Range)	Absolute Accuracy at
---------------	--------------------------------------	----------------------	------------------	--------------------------------------	---------------------------------	--------------------------	----------------------



Positive Full Scale	Negative Full Scale							Full Scale <sup>1</sup> (µV)
10	-10	75	17	1	40	2	64	2,080
5	-5	85	8	1	40	2	64	1,045

<sup>1</sup> Absolute Accuracy at full scale numbers is valid immediately following internal calibration and assumes the device is operating within 10 °C of the last external calibration.  
Accuracies listed are valid for up to two years from the device external calibration.

AbsoluteAccuracy = OutputValue · (GainError) + Range · (OffsetError)

GainError = ResidualGainError + GainTempco · (TempChangeFromLastInternalCal) + ReferenceTempco · (TempChangeFromLastExternalCal)

OffsetError = ResidualOffsetError + AOOffsetTempco · (TempChangeFromLastInternalCal) + INL\_Error

## Digital I/O/PFI

### Static Characteristics

Number of channels

NI 6250/6251/6255	24 total, 8 (P0.<0..7>), 16 (PFI <0..7>/P1, PFI <8..15>/P2)
NI 6254/6259	48 total, 32 (P0.<0..31>), 16 (PFI <0..7>/P1, PFI <8..15>/P2)
Ground reference	D GND
Direction control	Each terminal individually programmable as input or output
Pull-down resistor	50 kΩ typ, 20 kΩ min
Input voltage protection <sup>3</sup>	±20 V on up to two pins

<sup>3</sup> Stresses beyond those listed under Input voltage protection may cause permanent damage to the device.

### Waveform Characteristics (Port 0 Only)

Terminals used

NI 6250/6251/6255	Port 0 (P0.<0..7>)
NI 6254/6259	Port 0 (P0.<0..31>)

Port/sample size

NI 6250/6251/6255	Up to 8 bits
NI 6254/6259	Up to 32 bits

Waveform generation (DO) FIFO

2,047 samples

Waveform acquisition (DI) FIFO

2,047 samples

DI Sample Clock frequency

PCI/PCIe/PXI/PXle devices	0 to 10 MHz <sup>4</sup>
USB devices	0 to 1 MHz system dependent <sup>4</sup>

DO Sample Clock frequency

PCI/PCIe/PXI/PXle devices	
Regenerate from FIFO	0 to 10 MHz
Streaming from memory	0 to 1 MHz system dependent <sup>4</sup>
USB devices	
Regenerate from FIFO	0 to 10 MHz
Streaming from memory	0 to 1 MHz system dependent <sup>4</sup>

Data transfers

PCI/PCIe/PXI/PXle devices	DMA (scatter-gather), interrupts, programmed I/O
USB devices	USB Signal Stream, programmed I/O

DO or DI Sample Clock source<sup>5</sup>

Any PFI, RTSI, AI Sample or Convert Clock, AO Sample Clock, Ctr *n* Internal Output, and many other signals

4 Performance can be dependent on bus latency and volume of bus activity.

5 The digital subsystem does not have its own dedicated internal timing engine. Therefore, a sample clock must be provided from another subsystem on the device or an external source.

**PFI/Port 1/Port 2 Functionality**

Functionality	Static digital input, static digital output, timing input, timing output
Timing output sources	Many AI, AO, counter, DI, DO timing signals
Debounce filter settings	125 ns, 6.425 $\mu$ s, 2.56 ms, disable; high and low transitions; selectable per input

Recommended Operation Conditions <sup>6</sup>		
Level	Min	Max
Input high voltage ( $V_{IH}$ )	2.2 V	5.25 V
Input low voltage ( $V_{IL}$ )	0 V	0.8 V
Output high current ( $I_{OH}$ )		
P0.<0..31>	—	-24 mA
PFI <0..15>/P1/P2	—	-16 mA
Output low current ( $I_{OL}$ )		
P0.<0..31>	—	24 mA
PFI <0..15>/P1/P2	—	16 mA

Electrical Characteristics		
Level	Min	Max
Positive-going threshold ( $V_{T+}$ )	—	2.2 V
Negative-going threshold ( $V_{T-}$ )	0.8 V	—
Delta VT hysteresis ( $V_{T+} - V_{T-}$ )	0.2 V	—
$I_{IL}$ input low current ( $V_{in} = 0$ V)	—	-10 $\mu$ A
$I_{IH}$ input high current ( $V_{in} = 5$ V)	—	250 $\mu$ A

**Digital I/O Characteristics<sup>6</sup>**

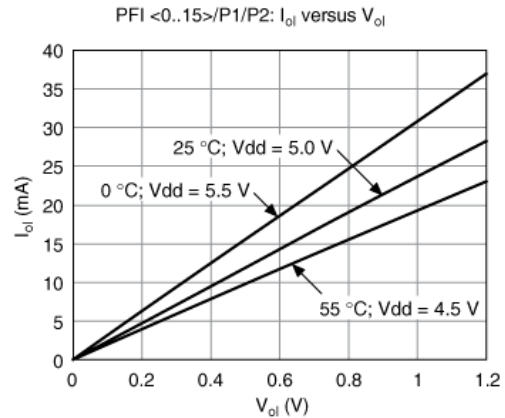
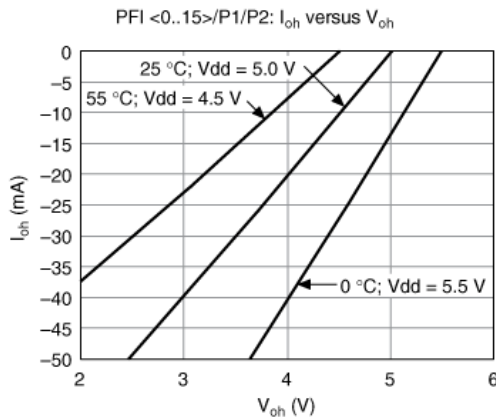
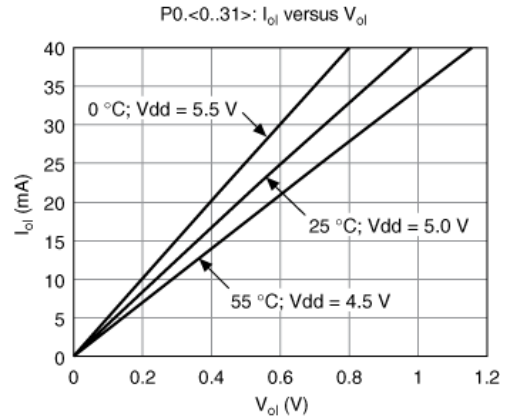
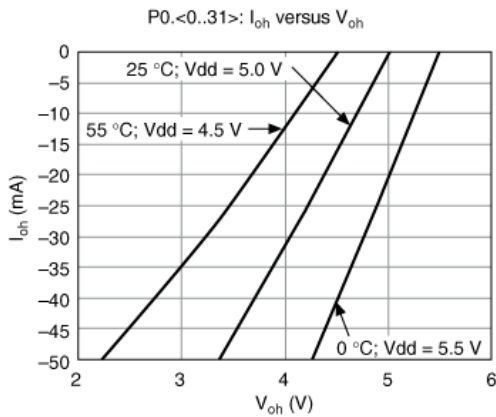

<sup>6</sup> On earlier versions of the USB-6251 Screw Terminal (part numbers 194929A/B/C-0x) and the USB-6259 Screw Terminal (part numbers 194021B/C-0x), the digital I/O characteristics of P0.<16..31> match the characteristics of PFI <0..15>. Refer to the November 2006 version of the *NI 625x Specifications* (part number 371291G-01) for more details.

## General-Purpose Counter/Timers

Number of counter/timers	2
Resolution	32 bits
Counter measurements	Edge counting, pulse, semi-period, period, two-edge separation
Position measurements	X1, X2, X4 quadrature encoding with Channel Z reloading; two-pulse encoding
Output applications	Pulse, pulse train with dynamic updates, frequency division, equivalent time sampling
Internal base clocks	80 MHz, 20 MHz, 0.1 MHz
External base clock frequency	0 MHz to 20 MHz
Base clock accuracy	50 ppm
Inputs	Gate, Source, HW_Arm, Aux, A, B, Z, Up_Down
Routing options for inputs	Any PFI, RTSI, PXI_TRIG, PXI_STAR, analog trigger, many internal signals
FIFO	2 samples
Data transfers	
PCI/PCIe/PXI/PXLe devices	Dedicated scatter-gather DMA controller for each counter/timer; interrupts, programmed I/O
USB devices	USB Signal Stream, programmed I/O

## Frequency Generator

Number of channels	1
Base clocks	10 MHz, 100 kHz
Divisors	1 to 16
Base clock accuracy	50 ppm
Output can be available on any PFI or RTSI terminal.	

## Phase-Locked Loop (PLL)

Number of PLLs	1
Reference signal	PXI_STAR, PXI_CLK10, RTSI <0..7>
Output of PLL	80 MHz Timebase; other signals derived from 80 MHz Timebase including 20 MHz and 100 kHz Timebases

## External Digital Triggers

Source	Any PFI, RTSI, PXI_TRIG, PXI_STAR
Polarity	Software-selectable for most signals
Analog input function	Start Trigger, Reference Trigger, Pause Trigger, Sample Clock, Convert Clock, Sample Clock Timebase
Analog output function	Start Trigger, Pause Trigger, Sample Clock, Sample Clock Timebase
Counter/timer functions	Gate, Source, HW_Arm, Aux, A, B, Z, Up_Down
Digital waveform generation (DO) function	Sample Clock
Digital waveform acquisition (DI) function	Sample Clock

## Device-To-Device Trigger Bus

PCI/PCIe devices	RTSI <0..7> <sup>7</sup>
PXI/PXLe devices	PXI_TRIG <0..7>, PXI_STAR
USB devices	None
Output selections	10 MHz Clock; frequency generator output; many internal signals
Debounce filter settings	125 ns, 6.425 $\mu$ s, 2.56 ms, disable; high and low transitions; selectable per input

<sup>7</sup> In other sections of this document, *RTSI* refers to *RTSI* <0..7> for PCI/PCle devices or *PXI\_TRIG* <0..7> for PXI/PXIe devices.

## Bus Interface

PCI/PXI devices	3.3 V or 5 V signal environment
PCle devices	
Form factor	x1 PCI Express, specification v1.0a compliant
Slot compatibility	x1, x4, x8, and x16 PCI Express slots <sup>8</sup>
PXIe devices	
Form factor	x1 PXI Express peripheral module, specification rev 1.0 compliant
Slot compatibility	x1 and x4 PXI Express or PXI Express hybrid slots
USB devices	USB 2.0 Hi-Speed or full-speed <sup>9,10</sup>
DMA channels (PCI/PCle/PXI/PXIe devices)	6, analog input, analog output, digital input, digital output, counter/timer 0, counter/timer 1
USB Signal Stream (USB devices)	4, can be used for analog input, analog output, digital input, digital output, counter/timer 0, counter/timer 1

All PXI-625x devices support one of the following features:

- May be installed in PXI Express hybrid slots
- Or, may be used to control SCXI in PXI/SCXI combo chassis

M Series Device	M Series Part Number	SCXI Control in PXI/SCXI Combo Chassis	PXI Express Hybrid Slot Compatible
PXI-6250	191325D-04/191325E-04L	No	Yes
PXI-6251	191325D-03/191325E-03L	No	Yes
	191325D-13/191325E-13L	Yes	No
PXI-6254	191325D-02/191325E-03L	No	Yes
PXI-6255	193618A-01	No	Yes
PXI-6259	191325D-01/191325E-01L	No	Yes
	191325D-11/191325E-11L	Yes	No
Earlier versions of PXI-6251/ 6254/6259	191325C-0x 191325B-0x	Yes	No

All NI PXIe-625x devices may be installed in PXI Express slots or PXI Express hybrid slots.

<sup>8</sup> Some motherboards reserve the x16 slot for graphics use. For PCI Express guidelines, refer to [ni.com/pciexpress](http://ni.com/pciexpress).

<sup>9</sup> If you are using a USB M Series device in full-speed mode, device performance will be lower and you will not be able to achieve maximum sampling/update rates.

<sup>10</sup> Operating on a full-speed bus may result in lower high-speed full-speed performance.

## Power Requirements

Current draw from bus during no-load condition<sup>11</sup>

PCI/PXI devices	
+5 V	0.03 A
+3.3 V	0.725 A
+12 V	0.35 A
PCle devices	
+3.3 V	0.925 A
+12 V	0.35 A
PXIe devices	
+3.3 V	0.45 A
+12 V	0.5 A

Current draw from bus during AI and AO overvoltage condition<sup>11</sup>

PCI/PXI devices	
+5 V	0.03 A
+3.3 V	1.2 A
+12 V	0.38 A
PCle devices	
+3.3 V	1.4 A

+12 V	0.38 A
PXle devices	
+3.3 V	0.48 A
+12 V	0.71 A

 **Caution** USB-625x devices must be powered with NI offered AC adapter or a National Electric Code (NEC) Class 2 DC source that meets the power requirements for the device and has appropriate safety certification marks for country of use.

USB power supply requirements 11 to 30 VDC, 20 W, locking or non-locking power jack with 0.080" diameter center pin, 5/16-32 thread for locking collars

<sup>11</sup> Does not include P0/PFI/P1/P2 and +5 V terminals.

## Power Limits

 **Caution** Exceeding the power limits may cause unpredictable behavior by the device and/or PC/chassis.

### PCI devices

+5 V terminal (connector 0)	1 A max <sup>12</sup>
+5 V terminal (connector 1)	1 A max <sup>12</sup>

### PCIe devices

Without disk drive power connector installed	
+5 V terminals combined	0.35 A max <sup>12</sup>
P0/PFI/P1/P2 and +5 V terminals combined	0.39 A max
With disk drive power connector installed	
+5 V terminal (connector 0)	1 A max <sup>12</sup>
+5 V terminal (connector 1)	1 A max <sup>12</sup>
P0/PFI/P1/P2 combined	0.39 A max

### PXI/PXle devices

+5 V terminal (connector 0)	1 A max <sup>12</sup>
+5 V terminal (connector 1)	1 A max <sup>12</sup>
P0/PFI/P1/P2 and +5 V terminals combined	2 A max

### USB devices

+5 V terminal	1 A max <sup>12</sup>
P0/PFI/P1/P2 and +5 V terminals combined	2 A max
Power supply fuse	2 A, 250 V

<sup>12</sup> Has a self-resetting fuse that opens when current exceeds this specification.

## Physical Requirements

### Printed circuit board dimensions

NI PCI-6250/6251/6254/6255/6259	9.7 × 15.5 cm (3.8 × 6.1 in.)
NI PCIe-6251/6259	9.9 × 16.8 cm (3.9 × 6.6 in.) (half-length)
NI PXI/PXIe-6250/6251/6254/6255/6259	Standard 3U PXI

### Enclosure dimensions (includes connectors)

NI USB-6251/6255/6259 Screw Terminal	26.67 × 17.09 × 4.45 cm (10.5 × 6.73 × 1.75 in.)
NI USB-6251/6259 BNC	28.6 × 17 × 6.9 cm (11.25 × 6.7 × 2.7 in.)
NI USB-6251/6255/6259 Mass Termination	18.8 × 17.09 × 4.45 cm (7.4 × 6.73 × 1.75 in.)
NI USB-6251/6255/6259 OEM	Refer to the <i>NI USB-622x/625x OEM User Guide</i>

### Weight

NI PCI-6250	142 g (5 oz)
NI PCI-6251	149 g (5.2 oz)
NI PCI-6254	152 g (5.3 oz)

NI PCI-6255	164 g (5.8 oz)
NI PCI-6259	162 g (5.6 oz)
NI PCIe-6251	161 g (5.7 oz)
NI PCIe-6259	175 g (6.1 oz)
NI PXI-6250	212 g (7.5 oz)
NI PXI-6251/6254	222 g (7.8 oz)
NI PXI-6255	236 g (8.3 oz)
NI PXI-6259	233 g (8.2 oz)
NI PXIe-6251	208 g (7.3 oz)
NI PXIe-6259	221 g (7.8 oz)
NI USB-6251 Screw Terminal	1.2 kg (2 lb 10 oz)
NI USB-6255/6259 Screw Terminal	1.24 kg (2 lb 11 oz)
NI USB-6251/6255/6259 Mass Termination	816 g (1 lb 12.8 oz)
NI USB-6251 OEM	140 g (4.9 oz)
NI USB-6255/6259 OEM	172 g (6.1 oz)
I/O connector	
NI PCI/PCIe/PXI/PXIe-6250/6251	1 68-pin VHDCI
NI PCI/PCIe/PXI/PXIe-6254/6255/6259	2 68-pin VHDCI
NI USB-6251 Screw Terminal	64 screw terminals
NI USB-6255/6259 Screw Terminal	128 screw terminals
NI USB-6251 BNC	21 BNCs and 30 screw terminals
NI USB-6259 BNC	32 BNCs and 60 screw terminals
NI USB-6251 Mass Termination	1 68-pin SCSI
NI USB-6255/6259 Mass Termination	2 68-pin SCSI
Disk drive power connector (PCIe devices)	Standard ATX peripheral connector (not serial ATA)
USB-6251/6255/6259 Screw Terminal/USB-6251/6259 BNC screw terminal wiring	16-28 AWG

### Maximum Working Voltage<sup>13</sup>

NI 6250/6251/6254/6255/6259 channel-to-earth	11 V, Measurement Category I
--	------------------------------



**Caution** Do *not* use for measurements within Categories II, III, or IV.

<sup>13</sup> Maximum working voltage refers to the signal voltage plus the common-mode voltage.

### Environmental

#### Operating temperature

PCI/PXI/PXIe devices	0 to 55 °C
PCIe devices	0 to 50 °C
USB devices	0 to 45 °C
Storage temperature	-20 to 70 °C
Humidity	10 to 90% RH, noncondensing
Maximum altitude	2,000 m
Pollution Degree (indoor use only)	2

### Shock and Vibration (PXI/PXIe Devices Only)

Operational shock	30 g peak, half-sine, 11 ms pulse (Tested in accordance with IEC-60068-2-27. Test profile developed in accordance with MIL-PRF-28800F.)
Random vibration	
Operating	5 to 500 Hz, 0.3 g <sub>rms</sub>

Nonoperating

5 to 500 Hz, 2.4 g<sub>rms</sub>

(Tested in accordance with IEC-60068-2-64. Nonoperating test profile exceeds the requirements of MIL-PRF-28800F, Class 3.)

## Safety

This product is designed to meet the requirements of the following standards of safety for electrical equipment for measurement, control, and laboratory use:

- IEC 61010-1, EN 61010-1
- UL 61010-1, CSA 61010-1



**Note** For UL and other safety certifications, refer to the product label or visit [ni.com/certification](http://ni.com/certification), search by model number or product line, and click the appropriate link in the Certification column.

## Electromagnetic Compatibility

This product is designed to meet the requirements of the following standards of EMC for electrical equipment for measurement, control, and laboratory use:

- EN 61326 EMC requirements; Minimum Immunity
- EN 55011 Emissions; Group 1, Class A
- CE, C-Tick, ICES, and FCC Part 15 Emissions; Class A



**Note** For EMC compliance, operate this device with shielded cables.

## CE Compliance

This product meets the essential requirements of applicable European Directives, as amended for CE marking, as follows:

- 73/23/EEC; Low-Voltage Directive (safety)
- 89/336/EEC; Electromagnetic Compatibility Directive (EMC)



**Note** Refer to the Declaration of Conformity (DoC) for this product for any additional regulatory compliance information. To obtain the DoC for this product, visit [ni.com/certification](http://ni.com/certification), search by model number or product line, and click the appropriate link in the Certification column.

## Environmental Management

National Instruments is committed to designing and manufacturing products in an environmentally responsible manner. NI recognizes that eliminating certain hazardous substances from our products is beneficial not only to the environment but also to NI customers.

For additional environmental information, refer to the NI and the Environment Web page at [ni.com/environment](http://ni.com/environment). This page contains the environmental regulations and directives with which NI complies, as well as other environmental information not included in this document.

## Waste Electrical and Electronic Equipment (WEEE)

At the end of their life cycle, all products must be sent to a WEEE recycling center. For more information about WEEE recycling centers and National Instruments WEEE initiatives, visit [ni.com/environment/weee.htm](http://ni.com/environment/weee.htm).

## 电子信息产品污染控制管理办法（中国 RoHS）



**中国客户** National Instruments 符合中国电子信息产品中限制使用某些有害物质指令 (RoHS)。  
关于 National Instruments 中国 RoHS 合规性信息, 请登录 [ni.com/environment/rohs\\_china](http://ni.com/environment/rohs_china)。  
(For information about China RoHS compliance, go to [ni.com/environment/rohs\\_china](http://ni.com/environment/rohs_china).)

[Back to Top](#)

## Pinouts/Front Panel Connections

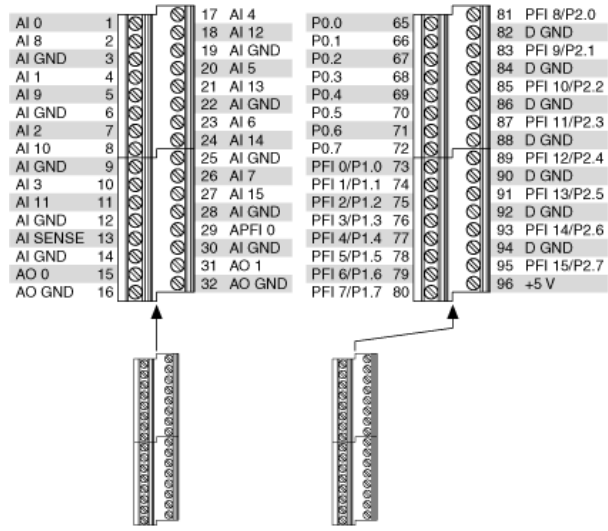

NI USB-6251 Screw Terminal Pinout



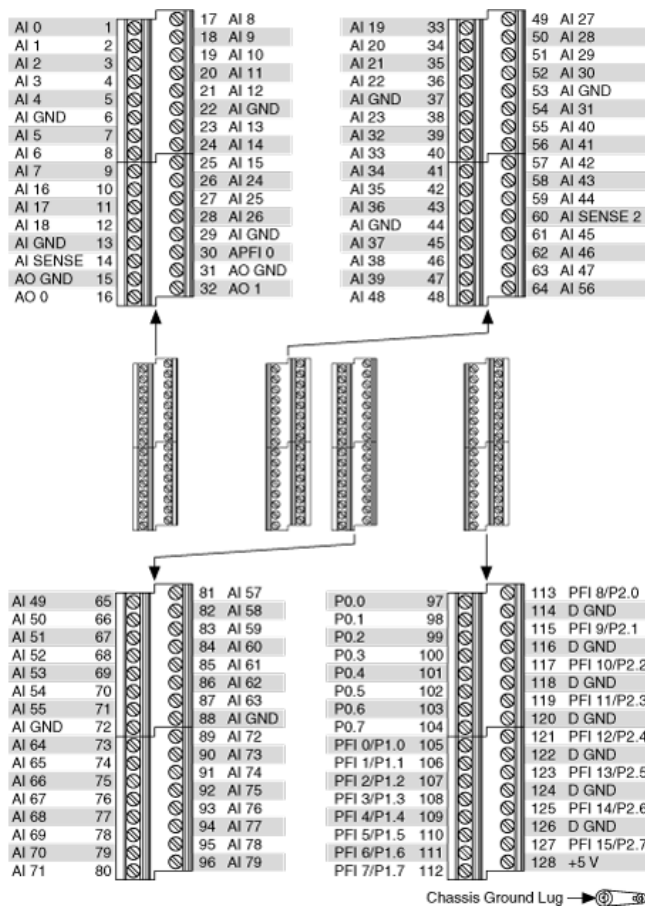

NI USB-6255 Screw Terminal Pinout

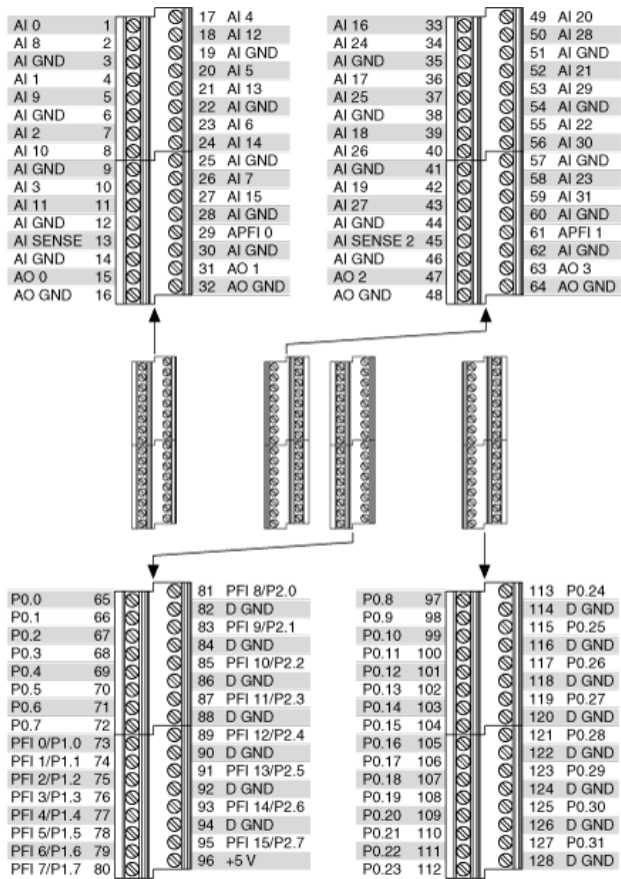

NI USB-6259 Screw Terminal Pinout

[Back to Top](#)

©2008 National Instruments. All rights reserved. CVI, LabVIEW, Measurement Studio, National Instruments, NI, ni.com, NI CompactDAQ, NI SoftMotion, SCXI, and SignalExpress are trademarks of National Instruments. The mark LabWindows is used under a license from Microsoft Corporation. Windows is a registered trademark of Microsoft Corporation in the United States and other countries. Other product and company names listed are trademarks or trade names of their respective companies.

[My Profile](#) | [RSS](#) | [Privacy](#) | [Legal](#) | [Contact NI](#) © 2014 National Instruments Corporation. All rights reserved.